

RADIO K ELECTRONICS

TELEVISION • SERVICING • HIGH FIDELITY

HUGO GERNSBACK, Editor

Stabilizing the
Feedback Amplifier

•
Glorious New Sound
for Motion Pictures

•
Licking Intermittents
With a Surge Checker

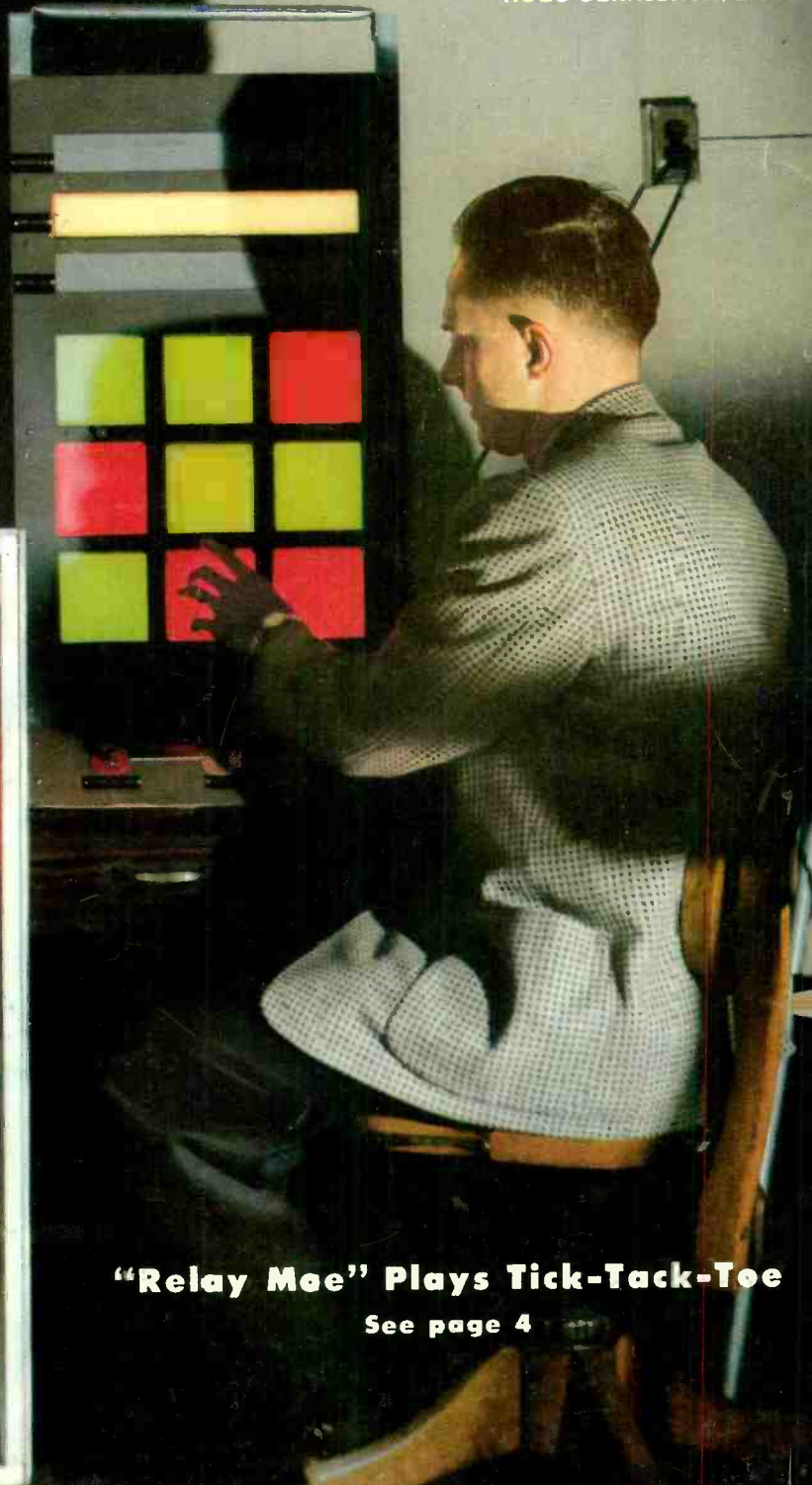
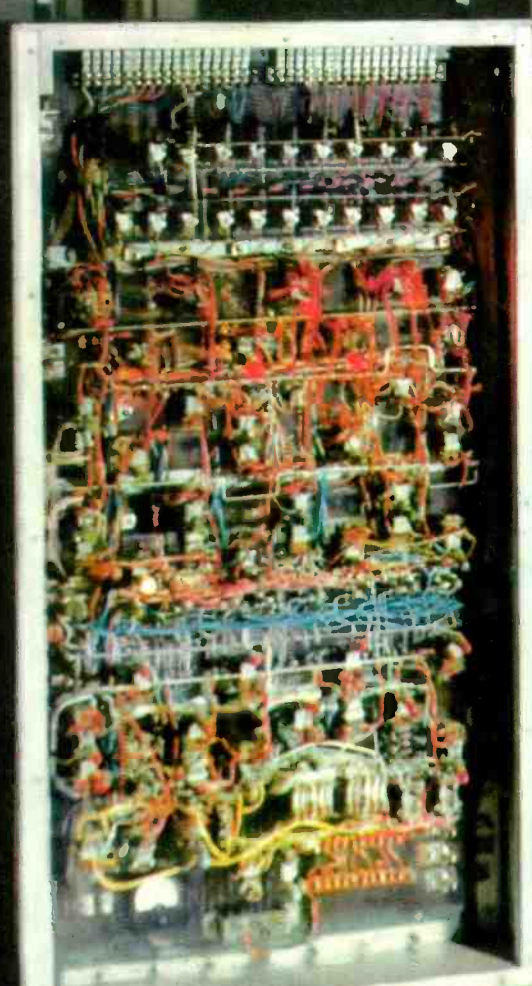

"Relay Mee" Plays Tick-Tack-Toe

See page 4

35¢

U. S. and
CANADA

ACTUAL SIZE

complete with selector switch...

TRIPLET

ELECTRICAL INSTRUMENT CO.
Bluffton, Ohio

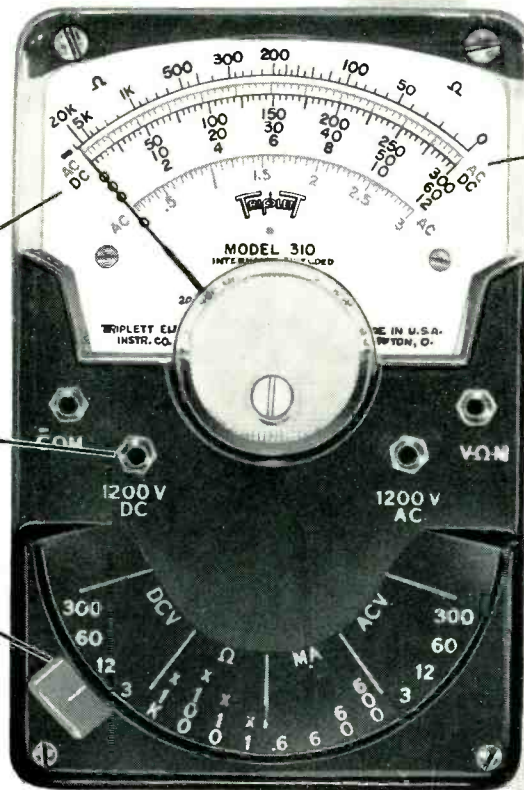

• 20,000 ohms per volt. D.C.

• BANANA-TYPE JACKS—positive connection and long life.

• EXCLUSIVE SELECTOR SWITCH speeds circuit and range settings. The first and only miniature VOM with this exclusive feature for quick, fool-proof selection of all ranges.

• 5,000 ohms per volt. A.C.



CARRYING CASE

Handsome leather carrying case with adequate space for Model 310 tester and accessories. Trouser belt slips through loop on back of the case for out-of-the-way carrying. MODEL 369 CASE—U.S.A. Dealer Net..... \$2.90

Model 310 MIGHTY MITE

the only complete miniature V-O-M (AC-DC)

LOOK AT ALL THESE RANGES

DC VOLTS: 0-3-12-60-300-1200 at 20,000 Ohms/Volt.
AC VOLTS: 0-3-12-60-300-1200 at 5,000 Ohms/Volt.
DC MICROAMPERES: 0-600 at 250 Millivolts.
DC MILLIAMPERES: 0-6-60-600 at 250 Millivolts.
OHMS: 0-20,000-200,000 (200-2000 at center scale).
MEGOHMS: 0-2-20 (20,000-200,000 Ohms at center scale).
OUTPUT: Convenient chart in instruction book.

ONLY **\$29⁵⁰** Dealer Net

SEE IT AT YOUR JOBBER
AND IT'S ONLY ONE OF TRIPLET'S MIGHTY NINE VOM LINE!



631
Combination
V-O-M—VTVM



630-NA
For Best Testing
Around The Lab,
Production Line
or Bench



630
The Popular
All-Purpose
V-O-M



630-A
A Good Lab and
Production Line
V-O-M



630-T
For Telephone
Service



666-HH
Medium Size
For
Field Testing



625-NA
The First V-O-M
With 10,000
Ohms/Volt AC



666-R
Medium Size
With
630 Features

BURTON BROWNE ADVERTISING

NATIONAL SCHOOLS

proudly presents

FOR MEN WHO WANT TO EARN MORE MONEY

TELERAMA • ALL 8 BRANCHES OF TELEVISION • ELECTRONICS • RADIO

IN **ONE** DYNAMIC, MODERN SHOP METHOD, HOME TRAINING COURSE

*Registration applied for

Another great advance in **HOME STUDY TRAINING**. Let National Schools, of Los Angeles, a practical Technical Resident Trade School for over 50 years, train you at home by Shop-Method, for today's unlimited opportunities in **ALL 8 BRANCHES** of the Television, Electronics, Radio Industry.

Check all you receive in *One Master Course* at One Low Tuition

1. Television — Including Color TV
2. Radio — FM and AM
3. Industrial Electronics
4. Sound Recording and Hi-Fidelity
5. Preparation for FCC License
6. Automation
7. Radar and Sonar
8. Communications

ALL OF THIS MODERN, NEWEST, PRACTICAL EQUIPMENT IS YOURS TO KEEP!

- Parts to Build a modern TV set, including large screen Picture Tube.
- Parts to build a powerful Superhet Receiver, standard broadcast and short wave.
- Parts to conduct many experiments and build Continuity Checker, RF Oscillator, TV Circuits, Audio Oscillator, TRF Receiver, Signal Generator.
- Professional Multitester
- These are a **MUST** for all technicians.

YOU DO MANY PRACTICAL JOBS. You do servicing, circuit analysis and many other down-to-earth experiments. You build a modern TV set from the ground up . . . with equipment kits we give you, including a new large screen picture tube and professional Multitester, at no additional charge.

EARN AS YOU LEARN! Many of our students earn their entire tuition and more in Spare Time jobs we show them how to do while learning. **YOU GET GRADUATE ADVISORY SERVICE, TOO.**

ALL YOURS TO KEEP

L. J. ROSENKRANZ
President of NATIONAL SCHOOLS



This Master-Shop-Method course is completely up-to-date. Here in Los Angeles, the TV and Electronics center of the world, we are able to keep in constant touch with the industries' latest developments. As a student, you will quickly master all phases at home . . . in your spare time. Your earning power will grow with every lesson. Just as thousands of National Schools graduates do every day, you can handle servicing, manufacturing, repairing, hundreds of other jobs, or make good money in your own business. **SECURE YOUR FUTURE—NOW. SEND COUPON BELOW.**



IN THESE MODERN TV STUDIOS, SHOPS AND LABORATORIES, your Shop Method Home Study Course was developed by experienced instructors and engineers. What an advantage that is to you at home — each lesson is tested, proved, easy to understand. You can master the most up-to-date projects, such as color TV set repair, printed circuits — even prepare for F.C.C. License and industrial electronics without taking a special course. **TAKE YOUR FIRST STEP NOW TO A TOP-PAY JOB IN TV, ELECTRONICS, RADIO. SEND COUPON BELOW TODAY.**



APPROVED FOR VETERANS AND NON-VETERANS

NATIONAL SCHOOLS

4000 S. FIGUEROA ST., LOS ANGELES 37, CALIF.
187 N. LA SALLE ST., CHICAGO 1, ILL.

IN CANADA: 811 W. Hastings St., Vancouver, B. C.

NATIONAL SCHOOLS

TECHNICAL TRADE TRAINING SINCE 1905
Los Angeles, California

GET FAST SERVICE — MAIL NOW TO OFFICE NEAREST YOU!

NATIONAL SCHOOLS, DEPT. RG-126
4000 S. FIGUEROA ST. OR 187 N. LA SALLE ST.
LOS ANGELES 37, CALIF. OR CHICAGO 1, ILL.
Rush free TV-Radio "Opportunity" Book and sample lesson. No salesman will call.

Name _____ Birthday _____ 19__

Address _____

City _____ Zone _____ State _____

Check if interested **ONLY** in Resident Training at Los Angeles. **VETERANS:** Give Date of Discharge.

MEMBER



FREE!

Fully illustrated "CAREER" BOOK in TV, Radio, Electronics. AND actual Sample Lesson—yours at no cost, no obligation **SEND COUPON NOW—TODAY!**



RADIO - ELECTRONICS

Formerly RADIO CRAFT • Incorporating SHORT WAVE CRAFT • TELEVISION NEWS • RADIO & TELEVISION*

ANNUAL INDEX

154 Vol. XXVII, January to December, 1956

EDITORIAL

33 Fifty Years of the Vacuum Tube—Hugo Gernsback

AUDIO—HIGH FIDELITY

- 34 Stabilizing Feedback Amplifiers—Norman H. Crowhurst
- 38 Complete Home Intercom System—John F. Millar
- 42 New Motion-Picture Sound—Aaron Nadell
- 45 High-Fidelity Grows Up
- 46 Stereo Tape Comes of Age, Part II—Herman Burstein

ELECTRONICS

- 49 Dry Cells Can Be Reactivated—Ralph W. Hallows
- 50 Relay Moe Plays Tick-Tack-Toe (Cover Feature)—Edmund C. Berkeley
- 53 Electronic Muscle Trainer Aids Arthritics—Alfred Haas
- 55 Sonar in One Hour—James H. Boyden

WHAT'S NEW

56 Pictorial Report of New Developments

TEST INSTRUMENTS

- 58 Surge Supply for Intermittents—Lyman E. Greenlee
- 60 Audio-Amplifier Tester—Homer L. Davidson
- 62 Scope Delivers Audio Test Signal—Charles F. Wolf

RADIO

- 78 New Resonant-Frequency Nomo Permits Greater Accuracy—Joseph F. Sodaro
- 80 Unique AM Tuner Improves Audio Quality—Peter J. Vogelgesang
- 82 Transistor Radios, Part VII—I. Queen
- 88 Portable Loop Homing Antenna—Ben Crisses and Jay Gnessin

TELEVISION

- 92 AGC in TV Alignment—Robert Baum and Herb Bowden
 - 101 TV Service Clinic—Conducted by Jerry Kass
 - 104 Tracking Down Intermittents—Robert G. Middleton
 - 105 TV DX—Robert B. Cooper
 - 107 Noise-Immunity Circuits; Rapid Field Service Methods—James A. McRoberts
- | | |
|--|---|
| <ul style="list-style-type: none"> 109 Abbreviations and Symbols 153 Books 148 Business 152 Correction 21 Correspondence 112 Miscellany 117 New Devices 112 New Records 124 New Tubes and Transistors | <ul style="list-style-type: none"> 140 Patents 146 People 133 Question Box 8 Radio Month 130 Radio-Electronic Circuits 151 Technical Literature 128 Technicians' News 136 Technotes 143 Try this One |
|--|---|

ON THE COVER

(Story on page 50)

An electronic player of children's games pits its skill against one of its constructors, Julius Skalski of Berkeley Enterprises.

Color original by Tom Carew

Hugo Gernsback Editor and Publisher

M. Harvey Gernsback Editorial Director

Fred Shunaman Managing Editor

Robert F. Scott W2PWG, Technical Editor

Jerome Kass Associate Editor

I. Queen Editorial Associate

Matthew Mandl Television Consultant

Elizabeth Stalcup Production Manager

Angie Pascale Editorial Production

Wm. Lyon McLaughlin Tech. Illustration Director

Sal Ehrlich Art Director

Lee Robinson General Manager

John J. Lamson Sales Manager

G. Aliquo Circulation Manager

Adam J. Smith Director, Newsstand Sales

Robert Fallath Promotion Manager

Average Paid Circulation over 184,000

NEXT MONTH: COMPLETE TV STATION LIST • HOW THE APPLE TUBE WORKS • BLACK-AND-WHITE ADJUSTMENTS IN COLOR TV

Associate Member Institute of High Fidelity Mrs., Inc.

RADIO-ELECTRONICS, December, 1956. Vol. XXVII, No. 12. Published monthly at Mt. Morris, Ill., by Gernsback Publications, Inc. Second-class mail privileges authorized at Mt. Morris, Ill. Copyright 1956 by Gernsback Publications, Inc. All rights reserved under Universal, International and Pan-American Copyright Conventions.

SUBSCRIPTION RATES: U. S., U. S. Possessions and Canada, \$3.50 for one year; \$6.00 for two years; \$8.00 for three years; single copies 35c. Pan-American countries \$4.00 for one year; \$7.00 for two years; \$9.50 for three years. All other countries \$4.50 a year; \$8.00 for two years; \$11.00 for three years.

SUBSCRIPTIONS: Address correspondence to Radio-Electronics, Subscription Dept., 404 N. Wesley Ave., Mt. Morris, Ill., or 154 West 14th St., New York 11, N. Y. When ordering a change please furnish an address stencil impression from a recent wrapper. Allow one month for change of address.

GERNSBACK PUBLICATIONS, INC. Executive, Editorial and Advertising Offices, 154 West 14th St., New York 11, N. Y. Telephone ALgonquin 5-7755. Hugo Gernsback, Chairman of the Board; M. Harvey Gernsback, President; G. Aliquo, Secretary.

BRANCH ADVERTISING OFFICES and FOREIGN AGENTS listed on page 164.

POSTMASTER: If undeliverable, send Form 3578 to: RADIO-ELECTRONICS, 154 West 14th St., New York 11, N. Y.

*Trademark registered U. S. Pat. Office.



JACK DEMPSEY
Former World's Heavy-weight Boxing Champion
Long-time friend and supporter of DeVry Tech.

Jack Dempsey says:

"Find Out TODAY How YOU MAY TRAIN AT HOME
For Great Opportunities in
TELEVISION
RADIO · ELECTRONICS



Nick Barton, Illinois, a DTL grad, now has his own business and tells us he is "literally snowed with work."



George D. Crouch, California, was a retail store clerk. He took the DeVry Program, and today is in business for himself.

See, too, How DeVry Tech Helps A Man Get Started in this Field

Get the Facts

FREE from

DEVRY TECH

Fill Out This Chart and Mail with Coupon . . . No Obligation!

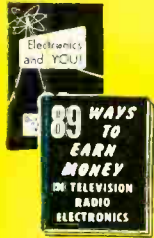

It costs you nothing to find out, and it may mean the turning point in your life. Let DeVry Tech tell you if you have the basic qualifications. Send in the personal rating chart today. Get the free leaflet, "89 Ways to Earn Money in Television-Radio-Electronics."

Free Sample Lesson



Let us give you without cost a Sample Lesson. See for yourself how easy it is to follow. DeVry Tech's down-to-earth instructions, practical training experiments, the test equipment you build and KEEP, the exclusive home training films . . . make learning simple and fast. Subject matter is broken down small enough and clearly enough for you to absorb it.

Get These Added Benefits

Whether you train at home or in our large, well-equipped, million-dollar Chicago Laboratories, you are not tied to a long-term contract . . . You have the privilege of canceling the program at any time.

ARE YOU DRAFT AGE? Mention it when you mail the coupon. We have valuable information for you. Accredited Member of National Home Study Council

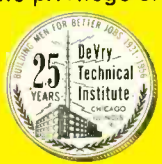

DEVRY TECHNICAL INSTITUTE
CHICAGO 41, ILLINOIS
FORMERLY
DEFOREST'S TRAINING, INC.
"One of America's Foremost Electronics Training Centers"

PERSONAL RATING CHART

- 1. AGE**—If you are between the ages of 17 and 55, place the numeral 5 in the square at right. If above or below those ages, mark yourself 3.
 - 2. EDUCATION**—If you have graduated from high school, mark 5 in the square at right. If you finished 8th grade, mark 3.
 - 3. DEPENDENTS**—If you are free to come to Chicago, rate yourself 5. If you prefer to study at home and hold your present job, put down the number 3.
 - 4. ABILITY**—If you've had any experience in handling a soldering iron or doing simple home wiring, rate yourself 5. If you feel you can follow simple "How-to-do-it" instructions, mark down 3.
 - 5. AMBITION**—Are you interested in training for a real future in a promising field? Mark down 5. Or do you simply want to prepare for a better job with more money? Put down 3.
- If you are subject to military service, please mark "X" here.

MAIL CHART AND COUPON NOW!

DEVRY TECHNICAL INSTITUTE
4141 Belmont Ave., Chicago 41, Ill., Dept. RE-12-M

I would like late facts about the many opportunities in Television-Radio-Electronics, including the 3 free publications, and how DeVry Tech may prepare me for my start in this billion-dollar field.

Name _____ Age _____
Please Print
Street _____ Apt. _____
City _____ Zone _____ State _____

1049A DeVry's Canadian Training Center is at 580 Roselawn Avenue, Toronto 12, Ontario



INTRODUCING BOGEN FLEX-PAK®*

*custom flexibility in packaged PA

EASIEST-TO-INSTALL, EASIEST-TO-SERVICE

portable or permanent . . . make more sales, more profits

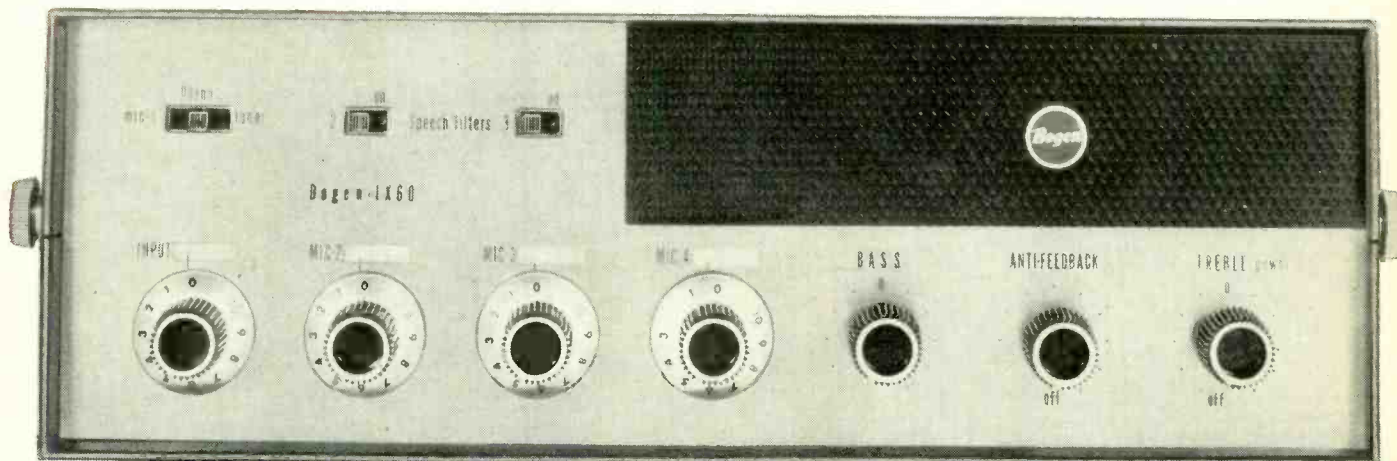

NEVER AGAIN need you miss a sale because your "packaged" PA equipment wasn't designed for a specific commercial installation—and your customer wouldn't stand still for an expensive custom design. Meet BOGEN's FLEX-PAK public address line. Here's true portability. Here's easy servicing. And here's all the flexibility, performance and dependability you'll need to satisfy 90% of your *commercial applications*—without going back to the manufacturer's "custom division" for expensive (i.e., hard-to-sell) special designs. And, thanks to FLEX-PAK design, your cost-conscious customer need buy only the equip-

ment he needs—and you can see him later about additional features. (Note that record player mounts, locking panels, remote controls are all *separate accessories*.) You can offer these systems in every price range, at practically every popular wattage, in three handsome BOGEN FLEX-PAK series: LX, L and K.

(1) Get in touch with your BOGEN representative immediately, or (2) mail for all FLEX-PAK specifications and prices by checking the coupon on the facing page. **NOTE:** we also supply famous-make indoor and outdoor speakers, microphones and other accessories for all your BOGEN public address system installations.

HOW'S THIS FOR EASY SERVICE ... EASY INSTALLATION

LOOSEN 4 THUMBSCREWS AND THE LID'S OFF for easy access for fast servicing.



FOLDS BACK WHEN NOT IN USE in easy-sliding accessory wall-mount bracket.



4 THUMBSCREWS ATTACH ACCESSORY RECORD PLAYER MOUNT. (Note: "cooling area" protects phono mechanism.)

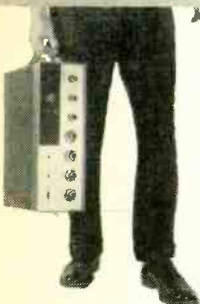

BRIEFCASE PORTABILITY thanks to slim design, handy on-end carrying straps.

WRITE-IN ON EACH GAIN CONTROL prevents embarrassing mistakes in volume settings. (Easy to erase markings.)



LOCKING PANEL (accessory) protects against tampering with settings. Covers entire control panel, not just on-off switch.

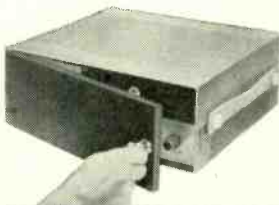

A BOGEN FLEX-PAK PA SYSTEM FOR EVERY USE...EVERY BUDGET

The amplifier-control units shown here are representative of more than twenty different models available to you—in all desired wattages; handsomely finished in dark gray with brushed aluminum face plate. Dealer net prices range from \$45 to \$155 for "full control" amplifiers.

DELUXE "LX" SERIES



LX30 30-WATTS

4 Microphone Inputs (panel switch converts one mike channel for phono or tuner)
Built-in Remote Gain-Control Circuit
Exclusive Anti-Feed-back Control
Speech Filters
Separate Bass and Treble Tone Controls
Size: Height: 5 3/8"
Width: 16 1/4"
Depth: 13"
Wgt.: 25 lbs.

SUPERB "L" SERIES

L330 30-WATTS

with accessory LPA-4 Manual Phono
3 Microphone Inputs (panel switch converts one mike channel for phono or tuner)
Speech Filters
Separate Bass and Treble Tone Controls
Size: Height: 5 3/8"
Width: 14 1/4"
Depth: 13"
Wgt.: 24 lbs. without phono



ECONOMICAL "K" SERIES



K130 30-WATTS

with accessory KPA-3 Manual Phono
1 Microphone Input
1 Phono Input
Speech Filter
Separate Bass and Treble Tone Controls
Size: Height: 6 1/4"
Width: 14"
Depth: 8"
Wgt.: 16 lbs. without phono

LX60 60-WATTS

with accessory LPA-4 4-speed Manual Phono
Except for slightly greater weight (29 1/2 lbs. without phono) and added power, the LX60 has same features and controls as LX30 shown above.

LPA-3 (3-speed) or LPA-4 (4-speed) phono mount includes manual record player, pan, legs, end pieces, couplings for easy mounting.



LOM PREAMPLIFIER CONTROL

5 Separate Microphone Gain Controls plus Master Gain Control.
1 Microphone channel converts to phono or tuner with selector switch on panel.

Illuminated Level (VU) Meter.

Separate Bass and Treble Tone Controls—plus Speech Filters for four microphone channels.

Size: Height: 5 3/8"
Width: 16 3/4"
Depth: 11"

Wgt.: 20 lbs.

KO100 100-WATTS

Powerful line amplifier. Built especially for long-term, dependable performance with no service problems.

Size: Height: 7 3/8"
Width: 17 3/8"
Depth: 6 1/2"

Wgt.: 28 lbs.



Bogen

PUBLIC ADDRESS SYSTEMS

A UNITRONICS CORPORATION AFFILIATE

MAIL THIS COUPON TODAY FOR DESCRIPTIVE BROCHURES AND PRICES

Dept. NX, David Bogen Co., Inc., P. O. Box 500, Paramus, N. J.
Gentlemen: Please send me descriptive literature and price information on your BOGEN FLEX-PAK public address equipment.

NAME _____

FIRM _____

check one dealer jobber sound specialist

ADDRESS _____

CITY _____ ZONE _____ STATE _____

Please send me 24-page, illustrated brochure, "What You Should Know About Sound Systems."

Please send me your 56-page, illustrated book, "Understanding High Fidelity," by L. H. Bogen and L. Biancoli. (I enclose 25c.)

**BEST BUILT
YET**

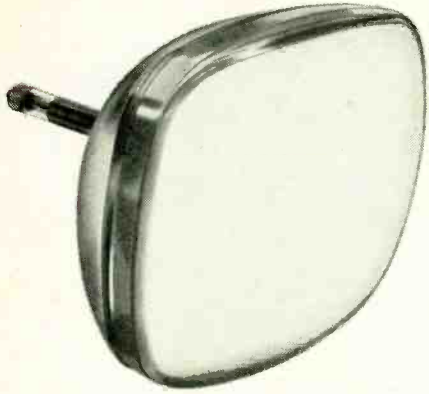

**BEST FOR
EVERY SET**



All Tung-Sol Tubes are engineered to one standard of quality—Blue Chip Quality. Whether they're for famous set makers or leading service dealers, Tung-Sol Tubes are identical in design and performance. Tell your supplier you'd rather have Tung-Sol!

Blue Chip Quality

TUNG-SOL

MAGIC MIRROR ALUMINIZED

**PICTURE TUBES
RECEIVING TUBES**

TUNG-SOL ELECTRIC INC., Newark 4, N. J. Sales Offices: Atlanta, Ga., Columbus, Ohio, Culver City, Calif., Dallas, Tex., Denver, Colo., Detroit, Mich., Irvington, N. J., Melrose Park, Ill., Newark, N. J., Seattle, Wash.

TUNG-SOL makes All-Glass Sealed Beam Lamps, Miniature Lamps, Signal Flashers, Picture Tubes, Radio, TV and Special Purpose Electron Tubes and Semiconductor Products.

the
**Radio
month**



ELECTRONIC LIGHT AMPLIFIER

which can increase by up to 1,000 times the brightness of projected light images, was demonstrated by RCA scientists in connection with General Sarnoff's 50th anniversary in radio. The electronic light amplifier (see photo) consists of a thin screen formed by two closely spaced layers, one of photoconductive material and the other of electroluminescent phosphor. Between these is a very thin layer of opaque material to prevent feeding back of light. The layers are sandwiched between two transparent electrodes and voltage is applied across the entire assembly.

When an extremely dim light image falls directly on the photoconductive layer, it permits a corresponding pattern of electric current to flow through to the electroluminescent layer. Under the influence of this current pattern the electroluminescent phosphor emits light, forming a high-brightness image of the original picture. The photoconductive material acts as an insulator in the absence of light; the electroluminescent material remains dark until it is excited by an electric current.

In the demonstration of the light amplifier, an image too dim to be seen clearly by the human eye was projected against the photoconductive layer on one side of a panel. On the other side of the panel, the image formed by the light emitted by the electroluminescent phosphor appeared as an extremely bright picture of television quality.

The application of the light amplifier to the amplifying fluoroscope for industrial X-ray use was also demonstrated. It produces an X-ray image about 100 times brighter than that

obtained with the conventional fluorescent screen, permitting viewing in a normally lighted room.

DR. LEE de FOREST, Father of Radio, has been made an Officer of the Legion of Honor. The Cross of the Legion was presented to him in a ceremony in Paris by M. Maurice Lemaire, French Minister of Industry and Commerce, on the occasion of the 50th anniversary of De Forest's invention of the triode vacuum tube. Speaking at the ceremony was Prince de Broglie, permanent secretary of the Academy of Sciences; M. Henri Damelet, president of the Federation of Radioelectric Industries; Minister Lemaire and other notables. Each paid high tribute to the decisive contributions of Dr. de Forest.

SARNOFF GOLDEN ANNIVERSARY in radio was celebrated with a dinner in honor of the RCA board chairman. Brig. Gen. David Sarnoff began his career on Sept. 30, 1906, as a messenger boy with the Marconi Wireless Telegraph Co. of America. Speaking to hundreds of friends and associates who gathered to pay him tribute for 50 years of service in radio, television and electronics, and deluged with congratulatory messages from notables and organizations throughout the world, Sarnoff predicted 20 major developments, both political and technical, within the next 20 years. They included the collapse of Soviet Communism, outlawing of war, vastly increased use of nuclear and solar energy, "farming" of oceans, control of weather, worldwide color and person-to-person TV, guided missiles carrying mail and freight.

(Continued on page 12)

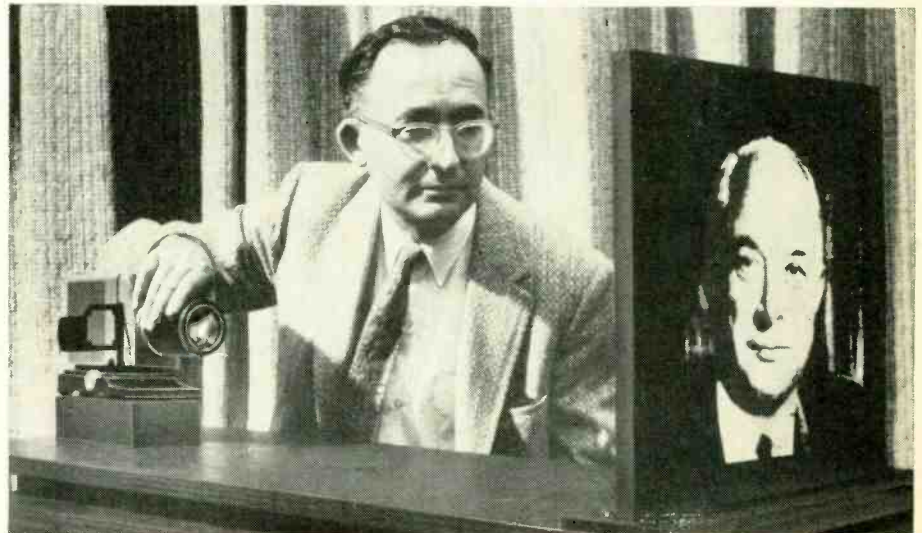

RADIO-ELECTRONICS

ATTENTION: MEN 17 to 55

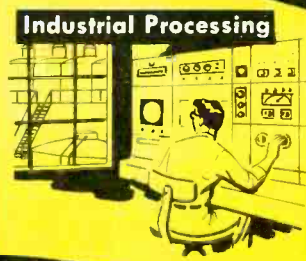

Does your present job offer advancement?

PREPARE NOW AT HOME FOR A PROFITABLE CAREER IN

AUTOMATION ELECTRONICS!

PRACTICAL NEW TRAINING METHOD IS THOROUGH, DOWN-TO-EARTH!

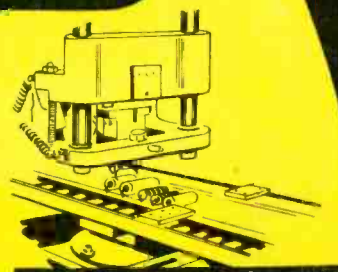

In plant after plant, many machines are being designed to run themselves. This is called "Automation." The jobs of some men who used to run these machines are gradually disappearing. Every year sees more changes; more unskilled jobs being replaced. But it's making many new jobs too—good-pay, solid-future jobs in plants, offices and elsewhere—for men who are trained in Automation Electronics.

started toward many wonderful and exciting opportunities. You have nothing to lose—and much to gain. Send that coupon now so we can tell you about it.

NOW IS THE TIME TO GET YOUR TRAINING
The design, operation and maintenance of controls that regulate the new "automatic equipment," is a promising field of the future. It's still uncrowded. There's time to get in on the ground floor if you act now.

MANY SUCCESSFUL GRADUATES
For 25 years, DTI has been building men for better jobs. Our files contain many letters from men who have won success in electronics and who give much credit to their DTI training.

NO PREVIOUS TECHNICAL TRAINING NEEDED
Many men 17 to 55, regardless of present job, even men without previous technical training or advanced education, can train for good jobs in Automation Electronics. DeVry Technical Institute offers effective training in your own home with movies, plenty of practical equipment and easy-to-read texts. Or get all of your training in DeVry's large well-equipped training laboratories in Chicago... one of the finest of its kind!

GET INTERESTING NEW BOOKLET

The interesting story of "Automation and YOU" is yours for the asking. Simply fill in... mail the coupon. See how DeVry's training programs may prepare YOU for a start in this coming new field.



WE HELP YOU GET STARTED IN THE FIELD
When you've completed the DTI training, you'll have the know-how—the practical training you need to hold down a good job in Automation. Our effective Employment Service will help you get



GET THIS BOOKLET FREE

DEVRY TECHNICAL INSTITUTE, Dept. RE-12A-M
4141 Belmont Avenue, Chicago 41, Ill.

I would like further information about the newer Electronic opportunities in AUTOMATION, also facts on how you may help me to prepare.

Name _____ Age _____
Please Print
 Street _____ Apt. _____
 City _____ Zone _____ State _____
 1040 **DTI's training is available in Canada**

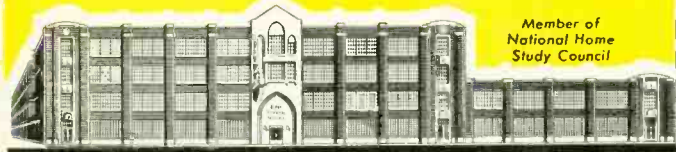

DEVRY TECHNICAL INSTITUTE
CHICAGO 41, ILLINOIS
FORMERLY
DEFORREST'S TRAINING, INC.

Member of National Home Study Council

One of America's Foremost Electronics Training Centers

**STOPS
TRAFFIC!**

\$



**SELLS
TRAFFIC!**

Capitalize on the growing two-set television market with this beautiful 5 color Telecoupler display. Cash-in on the increased Christmas sales of both black & white and color tv sets by displaying and selling AMPHENOL'S popular two-set coupler



AMPHENOL

TELE-COUPLER

see your
AMPHENOL
distributor

WHERE WILL YOU BE IN

Electronics

6 MONTHS FROM TODAY?

add technical training to your practical experience

get your FCC license quickly!

then use our effective job-finding service

Get These Valuable Booklets FREE . . .

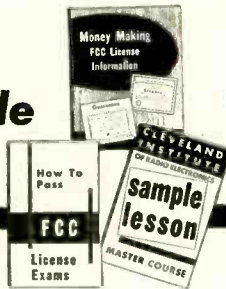

learn how
We guarantee
to train you until you receive
Your FCC license

If you fail to pass your Commercial License exam after completing our course, we guarantee to continue your training, without additional cost of any kind, until you successfully obtain your Commercial license.

Employers Make Offers Like These To Our Trainees Every Month!

Letter from nationally-known Airlines: "Radio Operators and Radio Mechanics are needed for our company. Periodic wage increase with opportunity for advancement. Both positions include many company benefits such as paid vacations, free flight mileage allowance and group insurance."

Letter from nationally-known manufacturer: "We have a very great need at the present time for radio-electronics technicians and would appreciate any helpful suggestions that you may be able to offer."

Here's Proof:

Name and Address	License	Time
Walter Eggers, Pacific Grove.....	1st	12 weeks
Paul Reichert, West Salem, Ohio.....	2nd	10 weeks
Harold Phipps, LaPorte, Indiana.....	1st	28 weeks
John H. Johnson, Boise City, Okla.....	2nd	12 weeks
James Faint, Johnstown, Pa.....	1st	26 weeks

We can provide names in your area on request.

Accredited by National Home Study Council



Cleveland Institute of Radio Electronics

Desk RE-98, 4900 Euclid Ave., Cleveland 3, O.

Please send Free Booklets prepared to help me get ahead in Electronics. I have had training or experience in Electronics as indicated below:

- | | |
|---|---|
| <input type="checkbox"/> Military | <input type="checkbox"/> Broadcasting |
| <input type="checkbox"/> Radio-TV Servicing | <input type="checkbox"/> Home Experimenting |
| <input type="checkbox"/> Manufacturing | <input type="checkbox"/> Telephone Company |
| <input type="checkbox"/> Amateur Radio | <input type="checkbox"/> Other..... |

In what kind of work are you now engaged? _____

In what branch of Electronics are you interested? _____

Name _____ Age _____

Address _____

City _____ Zone _____ State _____

Special Tuition Rates to Members of Armed Forces

learn how

OUR EFFECTIVE JOB-FINDING SERVICE Helps Cleveland Institute Trainees Get Better Jobs . . . Here are some recent examples

CHIEF ENGINEER

"Since enrolling with Cleveland Institute I have received my 1st class license, served as a transmitter engineer and am now Chief Engineer of Station WAIN. Also have a Motorola 2-Way Service Station. Thanks to the Institute for making this possible."

Lewis M. Owens, Columbia, Ky.

TEST ENGINEER

"I am pleased to inform you that I recently secured a position as Test Engineer with Melpar, Inc. (Subsidiary of Westinghouse). A substantial salary increase was involved. My Cleveland Institute training played a major role in qualifying me for this position."

Boyd Daugherty, Falls Church, Va.



Five years ago, on Sarnoff's 45th anniversary of service in radio, he asked for three "presents" from RCA scientists for his 50th anniversary. At the dinner, Dr. Engstrom announced that the gifts, representing major advances in electronics, were ready. Shown on color slides, they included an electronic air conditioner with no moving parts, a magnetic tape recording and playback system for black-and-white and color television and an electronic light amplifier.

SINGLE-GUN COLOR TUBE in mass-produced color TV receivers is goal of Du Mont program. Using the single-gun Chromatron of Chromatic Television Labs., plans are to produce a color receiver using a much simpler circuit than now found in commercial sets. It is hoped to complete this program within a year.

Calendar of Events

- Electronics Fair of Long Island, Dec. 6-8, New York State University, Farmingdale, N. Y. (RADIO-ELECTRONICS exhibits in Booth 42.)
- 1956 Eastern Joint Computer Conference, Dec. 10-12, Hotel New Yorker, New York City.
- RETMA Symposium on Applied Reliability, Dec. 19-20, Bovard Hall, University of Southern California, Los Angeles, Calif.
- Milwaukee High-Fidelity Music Show, Jan. 4-6, Milwaukee, Wis.
- 3d National Symposium on Reliability and Quality Control in Electronics, Jan. 14-16, Hotel Statler, Washington, D. C.
- Minneapolis High-Fidelity Music Show, Jan. 18-20, Minneapolis, Minn.
- Very-Low Frequency-Symposium, Jan. 23-25, NBS Laboratories, Boulder, Colo.

ATOMIC CLOCK, the world's most accurate timepiece, is exact to within 5 seconds in 300 years. Tabled the Atomichron, the clock's pendulum is the cesium atom which oscillates at a constant frequency of 9,192,631,830 mc. A clock dial may be attached to the device to tell time. The clock is immediately available to industry, and a few units have already been sold.

The Atomichron was developed by the National Co. Basically, the frequency of a 5-mc crystal oscillator is multiplied 1,836 times, yielding a signal of 9180 mc, approximately the resonant frequency of cesium. An atomic beam tube filled with cesium gas then detects any variation of the multiplied frequency from the cesium resonant frequency and applies a correction to the



5 IMPORTANT REASONS WHY



IS YOUR BEST BUY IN CONICALS!

Full line to select from; 8 single array antennas, 8 stacked antennas and 8 "Do-It-Yourself" antenna kits.

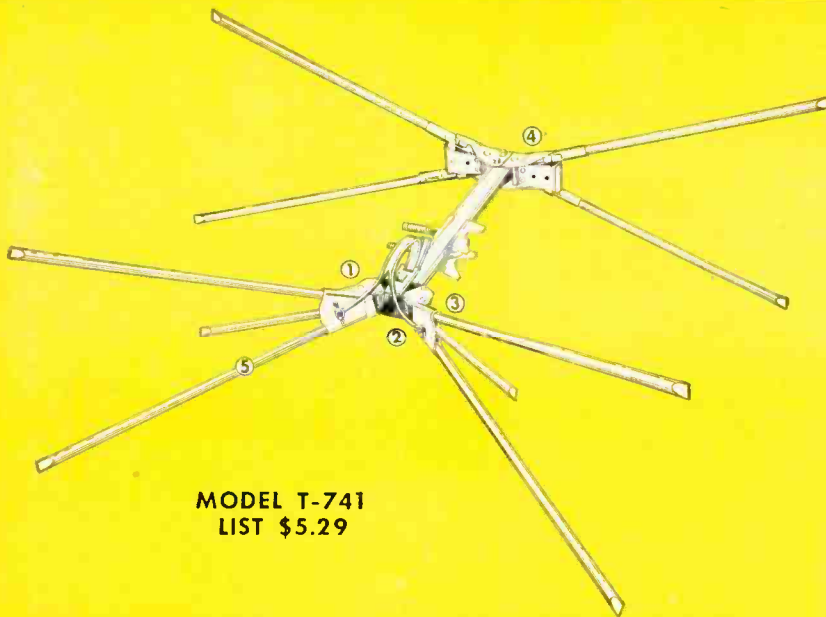

MODEL T-741
LIST \$5.29

The Facts Prove It!

- FACT No. 1** Completely pre-assembled. "Presto" Instant Mount Assembly opens antenna as easily and quickly as an umbrella.
- FACT No. 2** New Polyethylene Cable Anchor takes all tension off of terminals, prevents cable from breaking at terminal points.
- FACT No. 3** Front Bracket made of heavy spring temper aluminum alloy with High Q molded plastic insulator.
- FACT No. 4** Rear Bracket is made of heavy gauge aluminum to assure long life and resist heavy ice and strongest gales.
- FACT No. 5** Arrays are full size and of all aluminum construction. Elements are doweled to increase strength and prevent whistling.

The **Tenna** Manufacturing Co.
CLEVELAND 25, OHIO

An Open Letter To Independent TV & Radio Service Dealers

Way back in the forties when you had only to combat the suspicion and mistrust of the public — a mistrust created through unfavorable and unfair criticism in press and magazine — the Raytheon Manufacturing Company, recognizing this threat to your existence, started the Raytheon Bonded Electronic Technician Program in a sincere effort to help you survive. This program has helped thousands upon thousands of independent service dealers from coast to coast to establish themselves as reputable businessmen, increase their profits and gain the full respect of their customers.

The program has been carefully controlled. Membership in the Raytheon Bonded Dealer group has been kept limited and selected for 2 reasons: (1) Raytheon wants only the finest service organizations to bear this proud distinction, and (2) it represents a substantial investment for every dealer registered.

Today, the growth of Manufacturers' Service Organizations creates new problems for you in maintaining and increasing the business you have worked so hard to earn. To help you win and keep customer confidence, we are going to lift the quotas on the number of Bonded Dealers we will back. We know that many of you operate to standards that will enable you to qualify for the Raytheon Bond. We recognize your need for this support and gladly offer this helping hand.

We regret that this offer can be made for a limited time only. If you are interested in getting the help of the Raytheon Bond, get in touch with your Raytheon Sponsoring Bonded Tube Distributor right now. He will be delighted to show you how the Bond will help you build your business. And helping you — the independent service dealer — to prosper is something we at Raytheon are dedicated to do.



Receiving and Cathode Ray Tube Operations
Newton, Mass.



**New Styling...
New Features...
A Completely New Line
from H. H. Scott**

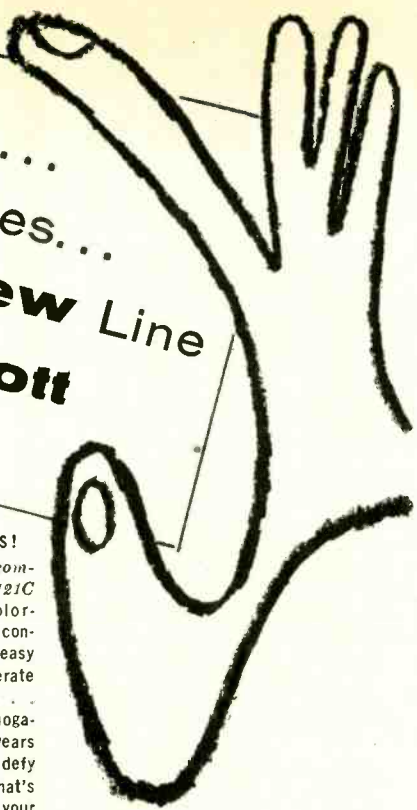

210E

3 NEW FEATURE-PACKED AMPLIFIERS!
(Models 90C, 210E complete amplifiers, 121C preamplifier) Color-marked Green Dot controls that make it easy for your family to operate your hi fi system . . . smartly designed mahogany cabinets . . . years ahead features that defy obsolescence . . . that's H. H. Scott for '57, your best dollar investment. See for yourself!



330B

4 NEW SUPER-SENSITIVE TUNERS!
(Models 330B, 331B AM-FM tuners; 311B, 310B FM tuners) For the first time AM that gives you audio response beyond 10 kc . . . FM with new wide-band circuitry that makes drift a thing of the past . . . AM-FM tuners equipped for Stereophonic (binaural) operation. That's H. H. Scott for '57. Hear for yourself!



280

2 COMPLETELY REDESIGNED POWER AMPLIFIERS!
(Models 240, 280) Exclusive Dynamic Power Monitor on Model 280 affords full output on music, yet protects expensive speakers against burnout . . . variable damping controls for perfect speaker matching . . . new exterior styling . . . clean distortion-free performance typical of all H. H. Scott components. Judge for yourself!

ALSO SEE THE NEW 710A TURNTABLE

Visit your dealer or write today for complete technical specs.

H. H. Scott Inc.
385 Putnam Ave.
Cambridge, Mass.



Please rush me your new catalog E-12 and complete technical specifications on H. H. Scott components for '57.

Name

Address

City

State



Rear section of Atomichron showing atomic beam tube. Left, Dr. Zacharias of MIT, key figure in the development; right, H. Guterman, board chairman of National Co.

5-mc crystal oscillator through an afe system. Output stability is maintained for the life of the instrument.

Principal applications for the atomic device are as a reference-frequency standard for calibration, as an elapsed-time measuring instrument, for communications monitoring and control. The Atomichron is based on fundamental discoveries by Prof. I. J. Rabi of Columbia University, who in 1945 outlined a blueprint for using the atomic frequencies as "cosmic pendulums" in an atomic clock that would tell time much more accurately than any other time-measuring device conceivable. The Bureau of Standards has done some work along this line and produced an experimental atomic clock a few years ago.

110° TV PICTURE TUBE has an overall length of only 14½ inches as compared with a length of 20 inches for a comparable 90° tube. The 110° represents the diagonal deflection of a tube having a diagonal of 21¾ inches and a viewing area of 262 inches. It weighs less than 23 pounds.

The new tube has a straight electron gun and does not use an ion-trap magnet. Image sharpness over the entire screen is maintained with an electrostatic focusing lens system. Another interesting feature of this aluminized tube is its extremely narrow neck diameter—1¼ inches. This permits the use of a deflecting yoke having increased deflection sensitivity. Only slightly more power is required for deflection than with a 90° tube.

The new 110° tube has an integral glass-button base with straight-through leads fitted with an indexing plug. This arrangement eliminates any possibility of loose base-pin connections. Developed by RCA, samples of this tube are being distributed to industry in 17- and 21-

(Continued on page 18)

free!

ALLIED'S 1957 value-packed 356-page CATALOG

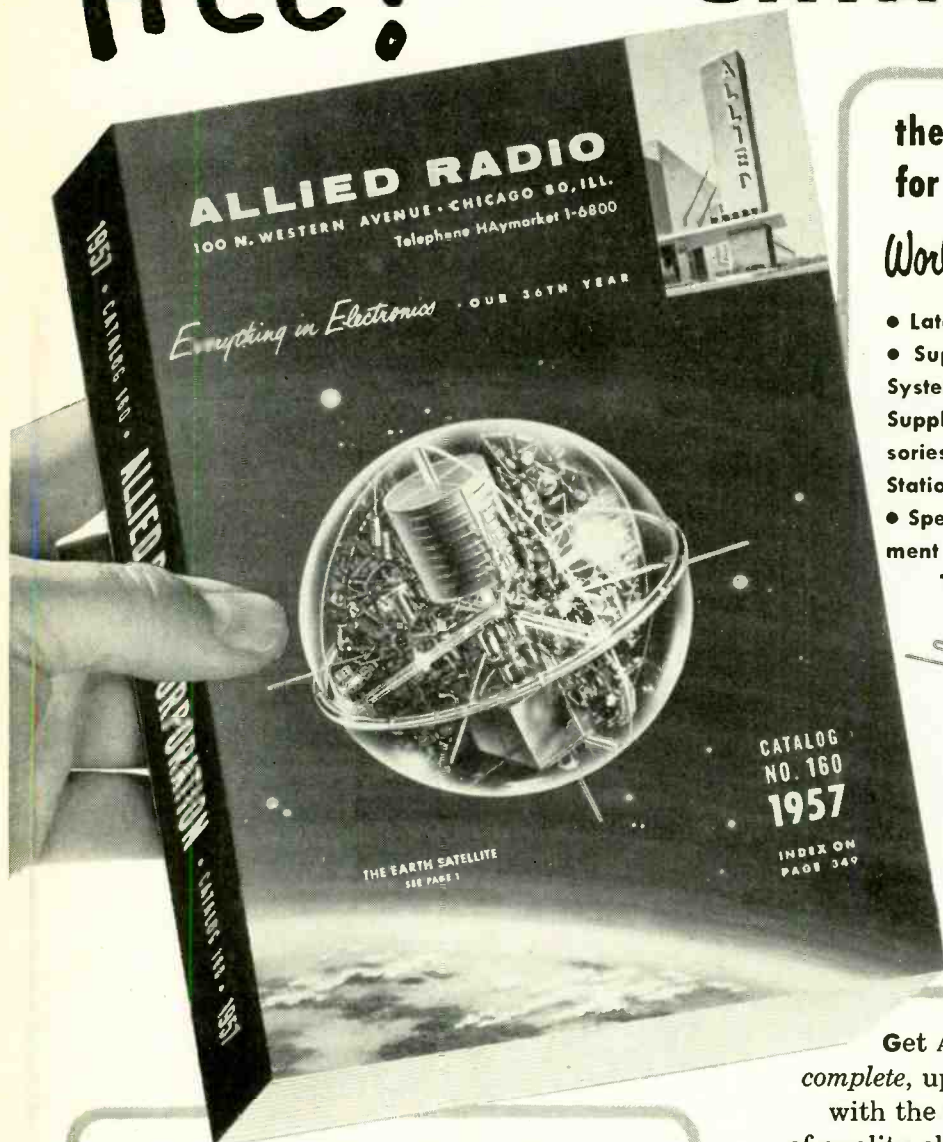

the only COMPLETE catalog
for everything in electronics

World's Most Complete Stocks

- Latest Hi-Fi Systems and Components
- Super-Value KNIGHT-KITS • P. A. Systems and Accessories • Recorders and Supplies • TV Tubes, Antennas, Accessories • Amateur Receivers, Transmitters, Station Gear • Test and Lab Instruments
- Specialized Industrial Electronic Equipment • Huge Listings of Parts, Tubes, Transistors, Tools and Books...

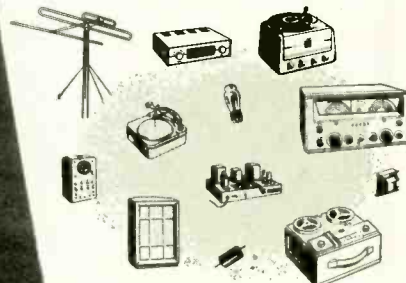

FEATURING

SUPER-VALUE knight-kits: Finest electronic equipment in money-saving Kit form—Test Instruments, Hi-Fi kits, Hobbyist kits, Ham kits. Easiest to build and you SAVE MORE.

EVERYTHING IN HI-FI: World's largest selection of quality Hi-Fi components and complete music systems—available for immediate shipment from stock. Own the best in Hi-Fi for less!

EASY-PAY TERMS: Only 10% down, up to 18 months to pay. Available on orders over \$45. Fast handling—no red tape.

Get ALLIED's 1957 Catalog—it's complete, up-to-date—356 pages packed with the world's largest selection of quality electronic equipment at lowest, money-saving prices. Get every buying advantage at ALLIED: fastest shipment, expert personal help, lowest prices, guaranteed satisfaction...

send for the leading
electronic supply guide



ALLIED RADIO CORP., Dept. 2-M-6
100 N. Western Ave., Chicago 80, Ill.

Send FREE 356-Page 1957 ALLIED Catalog

Name.....

Address.....

City..... Zone.... State.....



Our 36th year

ALLIED RADIO

World's Largest Electronic Supply House

When It's Designed and Built
by BLONDER-TONGUE...

There's a BIG Difference



UL approved

**B-T
LABS** **UHF
Converter**
MODEL "99" \$19.95
LIST

...and
for **ULTRA PERFORMANCE**

THE **B-T
LABS** *Ultravert*
Model BTU-2



at **\$39.95**
LIST

still leads every other unit in the field,
regardless of price, because of:

- Higher Gain
- Precise Impedance Match
- Automatic 'on/off'
- Lower Noise Factor
- Dual Speed Tuning
- Exclusive B-T Ultratuner

When B-T designs and builds an all-channel UHF converter to sell for less than \$20.00, you can be sure that it will outperform any other converter in its class...at least 4 ways:

1. **TUNED INPUT**—Tracks with oscillator—Rejects spurious signals—Suppresses oscillator radiation.
2. **PRECISE IMPEDANCE MATCH**—Maximum signal conversion—No line ghosts—No picture smear.
3. **ONE-KNOB TUNING**—No VHF channel switching.
4. **DRIFT-FREE PERFORMANCE**—Thermally compensated oscillator circuit.



Check with your supplier today...or write to Dept. TM-3

BLONDER-TONGUE LABORATORIES, INC.
WESTFIELD, NEW JERSEY

Manufacturers of TV Amplifiers, Boosters, Accessories, and Originators of the B-T 'Add-A-Unit' Master TV System.

In Canada: Telequipment, London, Ontario

NOW ... LOW-COST POWER TRANSISTORS!

CBS, leading manufacturer of power transistors for automobile radios and industrial equipment, offers you new low-cost power transistors delivering up to 10 watts output in Class B! Now you can build a variety of economical transistorized amplifiers capable of real power output.

The 2N255 and 2N256 PNP alloy-junction germanium transistors are designed for six- and twelve-volt battery operation respectively . . . ideal for mobile use. They feature high power coupled with high current amplification and their construction permits high heat dissipation.

Check the typical operating data. Order the 2N255 and 2N256 from your CBS Tube distributor . . . they are available now!



2N256 . . . \$3.45



2N255 . . . \$2.95

*Reliable products
through Advanced-Engineering*

TYPICAL OPERATING DATA

	2N255	2N256	
Battery voltage	6	12	volts
Class B push-pull output	5	10	watts
Class A output	1	2	watts
Distortion at max. output	Less than 10		per cent
Power gain, Class A	24	27	db
Total max. dissipation*	6.25	6.25	watts
Alpha cutoff frequency	200	200	kc

*With chassis as heat radiator.

Free . . . "CBS Power Transistor Applications"

This easy-to-read booklet gives data and operating notes for the CBS 2N255 and 2N256 in addition to six simplified power transistor circuits: Regulated power supply . . . code practice oscillator . . . d-c voltage multiplier . . . relay control . . . portable phonograph . . . and mobile public address system. It's free . . . from your CBS Tube distributor. Or write direct. Ask for CBS Power Transistor Applications, PA-16.



semiconductors

CBS-HYTRON

Semiconductor Operations, Lowell, Mass.

A Division of Columbia Broadcasting System, Inc.

have fun . . . save money

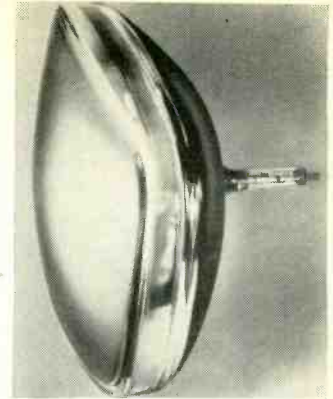

inch models. RCA also plans 14- and 24-inch tubes. Other picture-tube manufacturers are also making the new tube. Westinghouse said it would be in production of the 110° tubes by the first quarter of 1957, and Philco, says its subsidiary, Lansdale Tube Co., is now in production of 14- and 17-inch models of these wide-angle tubes and is making shipments.

RADIO-CONTROLLED QUARTER-BACK provides the most revolutionary football concept since the flying wedge. No more did coach Paul Brown of the Cleveland Browns rotate guards to deliver instructions to quarterback George Ratterman. George's helmet, wired for sound, is an invention of George A. Sarles, radio hobbyist.

Coach Brown spoke into a microphone which fed a 4-watt AM transmitter. The signal was then picked up by a five-transistor radio receiver built into the quarterback's helmet.

The helmet outside appears like any regulation type. Inside, a receiver, about 2 inches in diameter and ½ inch thick, is fastened to its top. A small earphone is attached alongside the left ear guard. The antenna is formed from strips of silver which line the inside of the helmet and are covered with lacquer and paint. The receiver is powered with a small battery, good for 30 hours of continuous service.

Apparently not appreciative of this new electronic technique, Bert Bell, commissioner of the National Football League, banned the device after several games. Sports writers and fans had objected to brainless quarterbacks.

FOUR NEW TV STATIONS have gone on the air since our last report:

WSYE-TV Elmira, N.Y.	18
WAGM-TV Presque Isle, Me.	8
KDIX-TV Dickinson, N.D.	2
KSIX-TV Corpus Christi, Tex.	10

One station has gone off the air: WTOM-TV Lansing, Mich. 54 Station WNOW-TV, York, Pa., channel 49, left the air since our last report but returned to operation during the same period.

Station WSYE-TV (above) is operating as partial satellite of station WSYR-TV, Syracuse, N.Y., channel 3.

The total of TV stations now operating in the U.S. and its territories is 489 (394 vhf, 95 uhf), including 22 non-commercial of which 5 are uhf. END

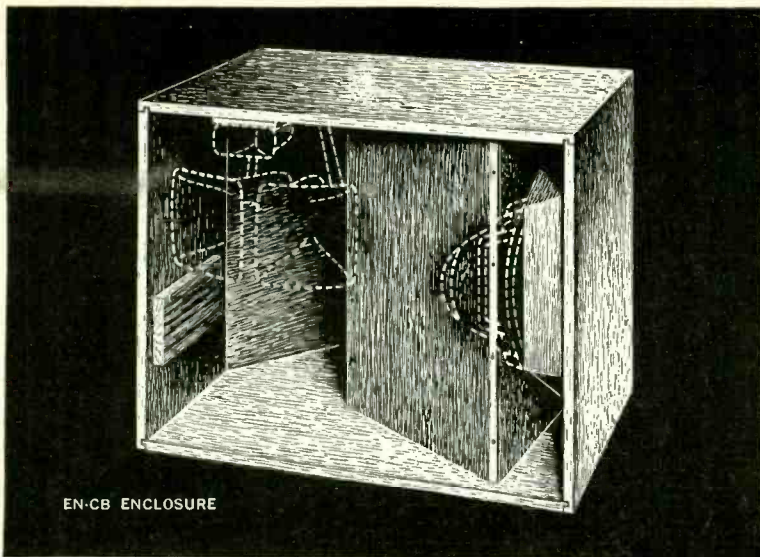

EN-CB ENCLOSURE

The famous University CLASSIC speaker system (shown at right), represents the highest achievement in audio engineering, the ultimate in sound! The CLASSIC is a true, folded, self-contained exponential horn which operates the woofer as a compression driver for maximum efficiency. Each detail has been so carefully worked out that the complete system functions as a beautifully coordinated team. A truly self-sufficient cabinet. It functions independently of walls and floor, achieving an amazing realism . . . almost like having a concert orchestra in your own home. The superb craftsmanship of the cabinet and high University standards to which the CLASSIC components have been built make the price really attractive. Mahogany \$450.00. Blond \$460.00.

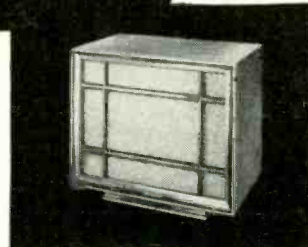

BUILD ONE OF THE FINEST SPEAKER SYSTEMS IN THE WORLD

University has taken the heart of the magnificent CLASSIC system and made it available as the EN-CB UNFINISHED-UTILITY enclosure. It came about as a result of an overwhelming demand on the part of "do-it-yourself" enthusiasts who wanted to build their own CLASSIC system. The price of the EN-CB is only \$120.00

The EN-CB is a superb piece of craftsmanship—constructed of Grade 1 Birch plywood using locked and mitred joints and braced with heavy glue blocks for maximum efficiency. Supplied with full instructions to mount speakers and network components. Designed acoustically to permit versatile use as "lowboy" or "highboy."

Naturally, all speakers sound better in an EN-CB. Recommended are CLASSIC components: C15W woofer, Cobreflex-2 mid-range horn with T-30 driver, HF-206 "Reciprocating-Flare" super-tweeter and N-3 ACOUSTIC BATON crossover network.

The EN-CB is a boon to the home decorator who plans to custom build part of his furniture. Decorating ideas are limitless: **BUILT-INS**—Easily installed into closet or wall, or into large wall-to-wall installations.

ROOM-DIVIDERS—Can be used vertically or horizontally.

PICK A PERIOD—Any furniture period can be achieved by treatment of front frame moulding, base, grille fabric, etc.

CUSTOM FINISHING—Can be stained and finished Blond, Mahogany, etc. Surface treatments: enamel, leather, formica, etc.

THE COMPONENTS THAT MAKE THE CLASSIC THE ULTIMATE IN SOUND



C15W



HF-206



COBREFLEX-2



T-30



N-3



BUILT-INS



ROOM-DIVIDERS

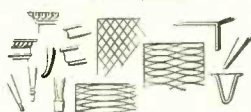

PICK A PERIOD



CUSTOM FINISHING

LISTEN

University sounds better



UNIVERSITY LOUDSPEAKERS, INC., 80 SOUTH KENSICO AVENUE, WHITE PLAINS, N. Y.

You Can Train at Home for Good Pay Jobs in RADIO-TELEVISION

Fast Growing Industry Offers Good Pay, Security, Bright Future

LESSON AND CATALOG FREE MAIL CARD

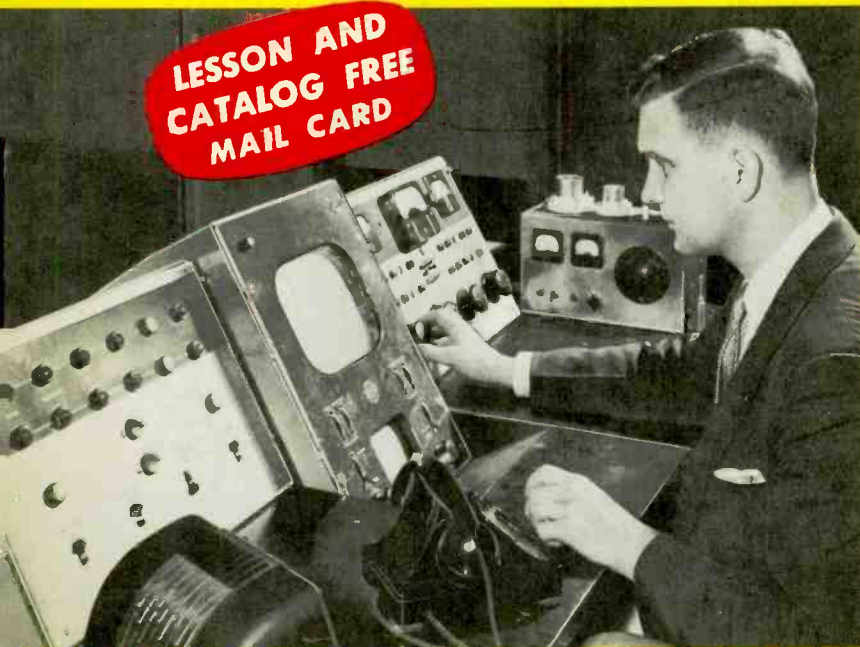

Training PLUS OPPORTUNITY is the ideal combination for success. Today's OPPORTUNITY field is Radio-Television. Over 125 million home Radios plus 30 million sets in cars and 40,000,000 Television sets mean big money, opportunity for trained Radio-Television Technicians. More than 4,000 Radio and TV Broadcasting stations offer interesting and important positions for technicians, operators. Color Television, portable TV sets, Hi-Fi, other developments assure future growth. Radio, Television are both growing. Need for trained technicians is increasing!



J. E. SMITH
Founder

Find Out What Oldest and Largest Home Study Radio-Television School Offers You

Since 1914—for more than 40 years—N.R.I. has been training ambitious men at home in spare time for Radio-TV. Thousands of successful graduates say N.R.I.'s 50-50 training method is a fast, easy, effective way to higher earnings, desirable jobs. Carefully planned experiments and practice with equipment supplied free of extra charge, bring basic principles, techniques to life right in your own home. Find out what dependable training can do for you.

You Learn by Doing—Get Practical Experience with Kits N.R.I. Sends

Nothing takes the place of practical experience. As part of N.R.I. Servicing Course you build AC-DC Radio Receiver and Vacuum Tube Voltmeter shown below. Use them to make tests, conduct experiments, get practical experience. All equipment yours to keep.



Add to Your Income Starting Soon

Make \$10-\$15 a Week Extra Fixing Sets in Your Spare Time

Soon after enrolling, many N.R.I. students start earning extra money fixing neighbors' radio sets. Many earn enough extra to pay entire cost of course and provide capital to start their own full time Radio-TV business after getting N.R.I. Diploma. If you want a job with a future, find out how you can train at home for Radio-Television. Mail Postage Free postcard for Sample Lesson. See how practical it is to learn at home. Get 64-Page Catalog, too. See equipment you get, outlines of courses, facts about opportunities in this growing field. Prices of N.R.I. Courses are low, terms easy.



See Other Side

N.R.I. Training leads to good pay jobs like these. BROADCASTING: Chief Technician, Chief Operator, Remote Control Operator. **SERVICING:** Home and Auto Radios, P. A. Systems, Television Receivers, Electronic Controls, FM Radios, HI-FI. **SHIP AND HARBOR RADIO:** Chief Operator, Assistant Operator, Radiotelephone Operator. **POLICE RADIO:** Transmitter Operator, Receiver Serviceman. **GOVERNMENT RADIO:** Operator in Army, Navy, Marine Corps, Coast Guard, Forestry Service Dispatcher, Airways Radio Operator. **IN RADIO PLANTS:** Design Assistant, Transmitter Design Technician . . . AND MANY OTHERS.

N.R.I. TRAINED THESE MEN

Thanks N.R.I. for Good Start



"Right now I am doing spare-time repairs on Radios and Television. Going into full time servicing soon." **C. HIGGINS**, Waltham, Mass.

Quit Job to Start Business



"I decided to quit my job and do TV work full time. I love my work and am doing all right financially." **W. F. KLINE**, Cincinnati, Ohio

Engineer with Station WHPE



"I operated a successful Radio repair shop. Then I got a job with WHPE and now I am an engineer for WHPE." **VAN W. WORKMAN**, High Point, N. C.

N.R.I. Started His Way up



"I was a cab driver earning \$35 a week. Then I enrolled with N. R. I. Now tester with TV maker." **J. H. SHEPHERD**, Bloomington, Ind.

CUT OUT AND MAIL CARD NOW

SAMPLE LESSON AND CATALOG BOTH FREE NO STAMP NEEDED! WE PAY POSTAGE

This card entitles you to Actual Lesson on Servicing, shows how you learn Radio-Television at home. You'll also receive 64-Page Catalog.

NATIONAL RADIO INSTITUTE, Dept. F
Washington 9, D. C.

Please mail me the FREE sample lesson and 64-Page Catalog. (No Salesman will call.)

Name _____ Age _____
Address _____
City _____ Zone _____ State _____

Approved Member, National Home Study Council

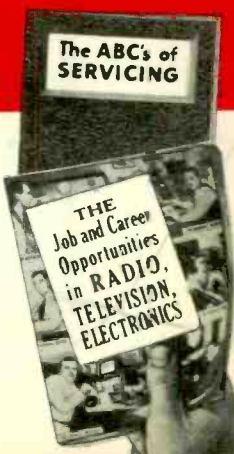

Practice Servicing-Communications with Kits of Parts N.R.I. Sends



YOU BUILD AC-DC Superhet Receiver

N.R.I. Servicing Course includes all needed parts. By introducing defects you get actual servicing experience practicing with this modern receiver. Learn-by-doing.

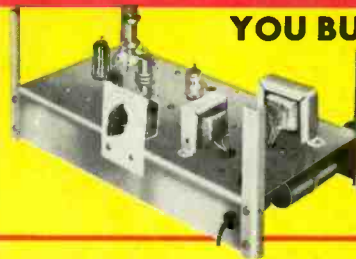

YOU BUILD Signal Generator

You build this Signal Generator. Learn how to compensate high frequency amplifiers, practice aligning typical I.F. amplifiers in receiver circuits. Make tests, conduct experiments.

YOU BUILD Broadcasting Transmitter

As part of N.R.I. Communications Course you build this low power Transmitter, learn commercial broadcasting operators' methods, procedures. Train for your FCC Commercial Operator's License.



YOU BUILD Vacuum Tube Voltmeter

Use it to earn extra cash fixing neighbors' sets; bring to life theory you learn from N.R.I.'s easy-to-understand texts.



Radio-Television Can Give You a Good Job with a Future

N.R.I. Graduates do Important Work — Get Important Pay



Chief Engineer with Station

"I am Chief Engineer of Station KGCU in Mandan, N. D. I also have my own spare time business servicing high frequency, two-way communications systems." R. BARNETT, Bismarck, N. D.

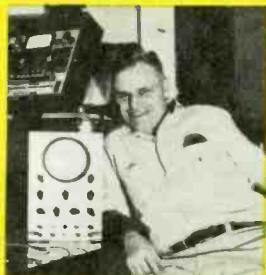

Paid for Instruments out of Earnings

"I am doing very well in spare time TV and Radio. Sometimes have three TV jobs waiting and also fix car Radios for garages. I paid for instruments out of earnings." G. F. SEAMAN, New York, N. Y.



Has Own Radio-TV Business

"We have an appliance store with our Radio and TV servicing and get TV repairs. During my Army service, N.R.I. training helped get me a top rated job." W. M. WEIDNER, Fairfax, S. D.

Here is a line of work that people respect—a vocation where you can advance, win a place for yourself, earn good pay and gain much personal satisfaction in what you are able to do. And you can learn at home in your spare time. Smart fellows everywhere are using their spare time to develop new knowledge, new skills. They know it is the trained man who gets ahead, gets the better job, drives the better car, is respected for what he knows and can do.

Be a Skilled Technician

The technical man is looked up to. He should be. He does important work, gets good pay for it. Radio-Television offers that kind of work. There are more than 40 million Televisions, 150 million home and auto Radios. Millions more are sold each year. There are splendid opportunities for the man well trained in Radio-Television Servicing or Broadcasting. Micro-Wave Relay, Aviation and Police Radio, Two-Way Communications for buses, taxis, trucks, etc. are expanding—making more jobs, greater opportunity.

You Can Train in Spare Time

Keep your job until you're ready for a better one. Learn at home. N.R.I. Courses are planned for men who can study only during spare time. You get many kits to build equipment, get practical experience. You work on circuits common to both Radio and TV. Equipment you build "brings to life" things you learn in N.R.I.'s easy-to-understand texts. Experienced N.R.I. instructors, technicians, specialists devote full time to making sure you get the best and simplest Radio-TV training. Train as fast or as slow as you like.

Tested Way To Better Pay

N.R.I. Training is practical, thorough. You get the benefit of N.R.I.'s 40 years experience training men for success in Radio-Television. Most successful N.R.I. men start without any knowledge of Radio, many without a high school education. Find out what Radio-Television training can mean to you. Make a decisive move today toward becoming one of that select group—a Radio-TV Technician. Send for Actual Lesson and 64-Page Catalog, both FREE. NATIONAL RADIO INSTITUTE, Dept. F, Washington, D. C.

See Other Side

FIRST CLASS

Permit No. 20-R

(Sec. 34.9, P. L. & R.)

Washington, D. C.

BUSINESS REPLY CARD

No Postage Stamp Necessary If Mailed In The United States

POSTAGE WILL BE PAID BY

NATIONAL RADIO INSTITUTE

16th and U Sts., N. W.

Washington 9, D. C.

SAMPLE LESSON AND CATALOG BOTH FREE

CUT OUT AND MAIL POSTAGE-FREE CARD

Correspondence



MORE FUSS ABOUT PLUS

Dear Editor:

Exasperation is at least the alternate mother of invention. And recently I became thoroughly exasperated with the orthodox symbol for selenium (or other contact) rectifiers. In using this orthodox symbol one must always understand that the maximum (easy or forward) current will flow in *electronic* direction, precisely opposite to the arrowhead direction. (See Fig. a.)

For example, in his article "Much Fuss About Plus" (RADIO-ELECTRONICS, April, 1956, page 102), Mr. Prenskey correctly hooks up the milliammeter, battery and rectifier as in Fig. b, to obtain the maximum current flow through the meter.

Note the emphasis here on *electronic* direction of flow. It is the concept accepted by most, if not all, of us who have grown up in electronics since the 1920's. The older (Ben Franklin) concept was that battery current flows around from "+" to "-." But now we believe, in accordance with electron-tube theory, that the current flows through the hot cathode (from battery -) to the cold plate or anode (battery +).

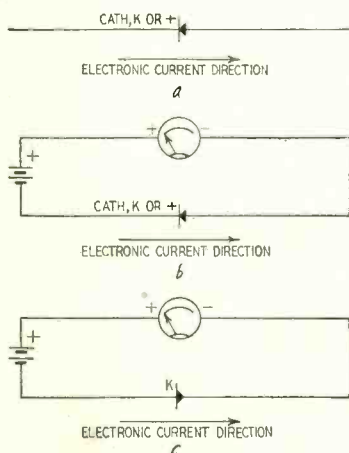

The rectifier arrowhead, as drawn, indicates current flow in accordance with the old Ben Franklin theory. Thus, if you use this symbol but at the same time trace out all your circuits in terms of the newer electron theory, the arrowhead is pointing precisely the "wrong" way. Indeed, so much "wrong" is the way that, when we work with complicated circuits like voltage triplers and quadruplers, we become thoroughly confused, even to the point of making catastrophic practical errors. So it was that I became thoroughly exasperated

6 GOOD REASONS

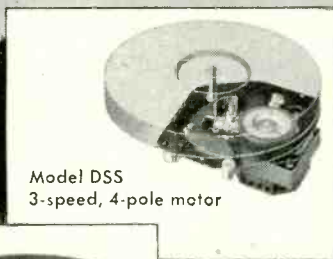

Model DSS
3-speed, 4-pole motor

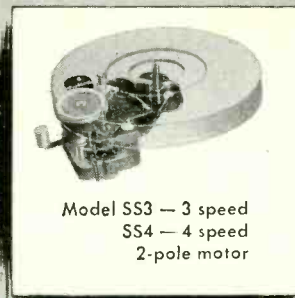

Model SS3 — 3 speed
SS4 — 4 speed
2-pole motor

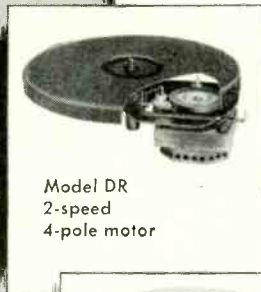

Model DR
2-speed
4-pole motor

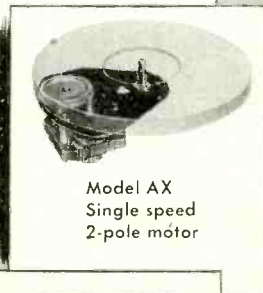

Model AX
Single speed
2-pole motor

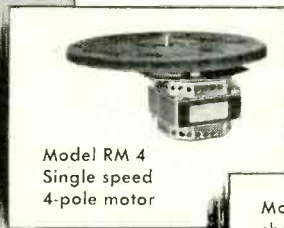

Model RM 4
Single speed
4-pole motor

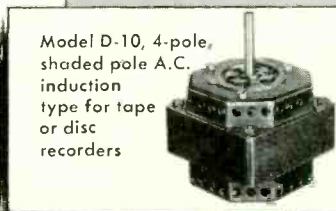

Model D-10, 4-pole,
shaded pole A.C.
induction
type for tape
or disc
recorders

why so many leading manufacturers

RELY on GI PHONOMOTORS

- FOR PORTABLE PHONOS • FOR HI-FI UNITS • FOR COMBINATIONS • FOR RECORD CHANGERS • FOR TAPE RECORDERS • FOR REPLACEMENT USE • FOR EVERY PHONO APPLICATION

Follow the lead of America's foremost manufacturers — Specify GI for all your phonomotor needs. A complete range of speeds and types to meet every requirement — backed by over half a century of design leadership!

Other General Industries AC induction type motors for applications ranging from 1/40 HP to 1/1100 HP.



THE GENERAL INDUSTRIES CO.

DEPT. GR • ELYRIA, OHIO

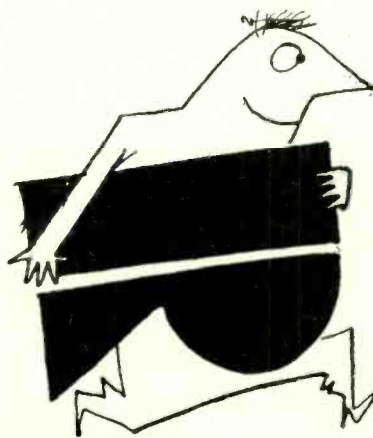

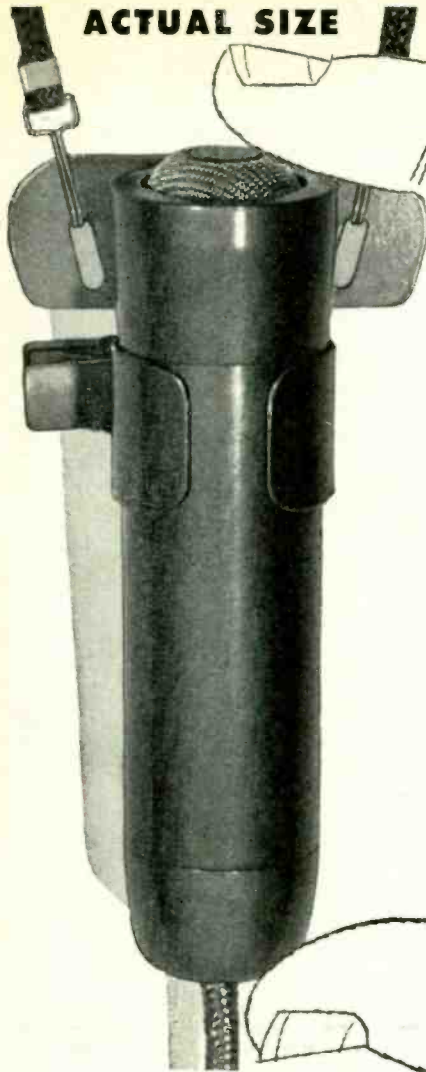

58 TURNER MODEL

*New high fidelity
dynamic miniature*

VERSATILE MODEL 58, a superior lavalier microphone, meets TV, broadcasting, recording, PA requirements for performance, durability, compactness and adaptability. High fidelity Model 58 has the sensitive-but-rugged new Turner Dynaflex diaphragm, designed to resist shock, temperature extremes, moisture. Response: 60 - 13,000 c.p.s. Level -57 db at high impedance. Write today for more information.

MODEL 58 (high & low impedance)	} List Price	\$5700
MODEL 58A (50 or 200 ohms impedance)		
Support clip, neck cord, 25-ft. cable		
MODEL G-4 Swivel Desk Stand	List Price	\$5.75

THE TURNER COMPANY

CORRESPONDENCE

(Continued)

with the standard symbol and, as a nonconfusing expedient, adopted the practice of turning the arrowhead around (Fig. c) so that it would indicate the *electronic* direction in which the current flows.

We now have a rectifier symbol whose arrowhead indicates the electronic direction of easy or forward or maximum current flow. It is a logical symbol and one that will not introduce any ambiguity into circuit analysis. It is still early in the game and an excellent time to standardize.

A mere symbol may seem a small thing. Yet without such symbols, including words, we simply could not think. If you believe you are able to think without symbols, just try to frame a wordless thought! So if our thought is to proceed at all, and moreover clearly and easily, we must have clear and easy symbols. Never again will I, brought up in the electron-tube theory of current flow, use the old symbol for a rectifier. Too confusing.

JOSEPH H. SUTTON

Kansas City, Mo.

TUBE JOCKEYS

Dear Editor:

TV tube jockeys flourish hereabouts, no less than elsewhere, but we must have a special breed—sort of an elite corps. Witness the following case histories as reported by viewers who called me in after the jockeys had left their several magic lanterns still unfixed. Match these, if you can.

Case 1. Complaint: extremely weak, violently pulling picture. After swapping tubes furiously for some time, the jockey finally removed the lead-in from the antenna posts, moistened his fingertips and experimentally stroked the two conductors. After about a minute he gravely announced that "Something is wrong with the antenna. Probably a broken wire. Anyway, the signals are very weak." (And just to think I dumped over a hundred bucks in a field-strength meter!)

Case 2. Complaint: White vertical line in picture about quarter of the way across the screen from left-hand side. Tube jockey's explanation: "That big tree across the road is splitting the beams from the TV stations. It's like radar, you know; the tree just naturally cuts a section out of the picture."

Case 3. Complaint: Snowy pictures, unusable about 6 days out of 7 (due to poor location behind range of steep hills). Referring to jockey he'd called in ahead of me, customer reported: "This man worked on the set for a long time and finally said the only way to get pictures here was by using two boosters. Only he said he was afraid to try it on account they'd probably blow out the tuner."

Is it to laugh? Or to weep?

H. A. HIGHSTONE

Star TV
Santa Rosa, Calif.



*another
EXACT
REPLACEMENT
first*

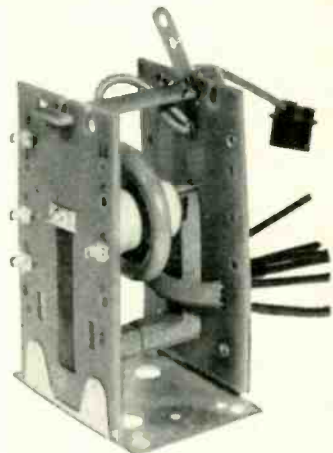

For exact replacement in over 60 G.E. models and chassis. HVO-59 replaces G.E. parts RTO-125, 126, 127. HVO-61 replaces G.E. parts RTO-129 & 130. Both feature Merit's NEW anti-corona ring plus exact lead color coding! Another in Merit's line of exact replacement transformers, yokes and coils—as always, the most complete in the industry. And Merit is the only manufacturer of these products who has complete production facilities for all parts sold under their brand name.

MERIT

MERIT COIL AND TRANSFORMER CORP.
4427 N. CLARK ST., CHICAGO 40, ILLINOIS

Free!



to Service Technicians Only

THE NEW SAMS INDEX TO PHOTOFACT FOLDERS

it keeps you up-to-the-minute on receiver coverage

PHOTOFACT Folders give you the world's finest Service data on TV and radio models just as soon as they hit the market. Now—with the new INDEX SYSTEM to PHOTOFACT, you locate the *latest* PHOTOFACT coverage *immediately*.

If you're a Service Technician, you can get the new Sams Index FREE. Here's how it keeps you up-to-date on receiver coverage: The Master Index (36 pages—issued twice yearly) is the complete reference to *all* PHOTOFACT Folders produced up to the date of its issue. In addition, you get an Index Supplement each month covering that month's releases of PHOTOFACT Folders. Thus, the Master Index *plus* the supplements keep you right up with current PHOTOFACT coverage. (The Index Supplements also appear each month in "PF Reporter" Magazine.)

It's easy to get your complete Index service to PHOTOFACT at NO COST to YOU. If you're a Service Technician, just fill in the coupon and mail to us today. It will bring the Master Index direct to your shop, and monthly supplements will be mailed to you regularly thereafter. YOU'LL KEEP RIGHT UP-TO-THE-MINUTE ON PHOTOFACT COVERAGE—you'll be able to locate the data you need on over 30,000 models, as well as on CURRENT MODEL RELEASES.

Mail coupon today for your free subscription to the Sams Photofact Index

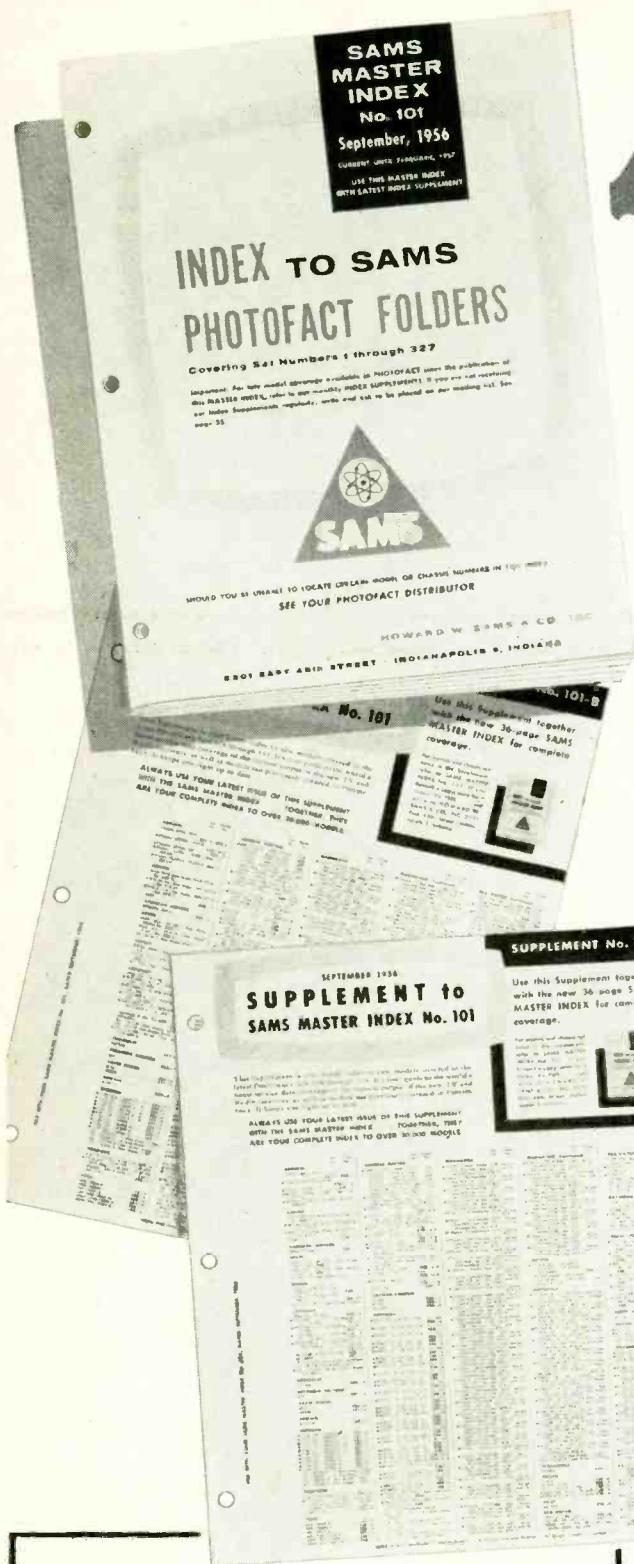

TAKE THE RIGHT STEP TO TIME-SAVING PROFIT-BUILDING BUSINESS: Sign up with your Parts Distributor to get PHOTOFACT Folder Sets automatically each month.

DO IT NOW!

HOWARD W. SAMS & CO., INC.

free!
TO SERVICE TECHNICIANS

Howard W. Sams & Co., Inc.
2205 E. 46th St., Indianapolis 5, Indiana

Send me your FREE Master Index to PHOTOFACT Folders (twice yearly), and put me on your mailing list to receive all Index Supplements. My letter-head and/or business card is attached.

I am a Service Technician: full time; part time.

My Distributor is: _____

Shop Name _____

Attn: _____

Address _____

City _____ Zone _____ State _____

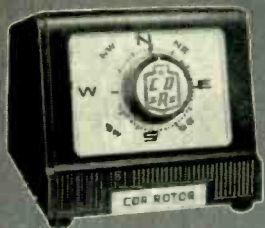

AR 1 and 2

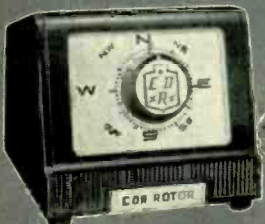

AR-22



TR-2



TR-4



TR 11 and 12



Everything You Need for Profitable Rotor Sales

CDR ROTORS

have EVERYTHING

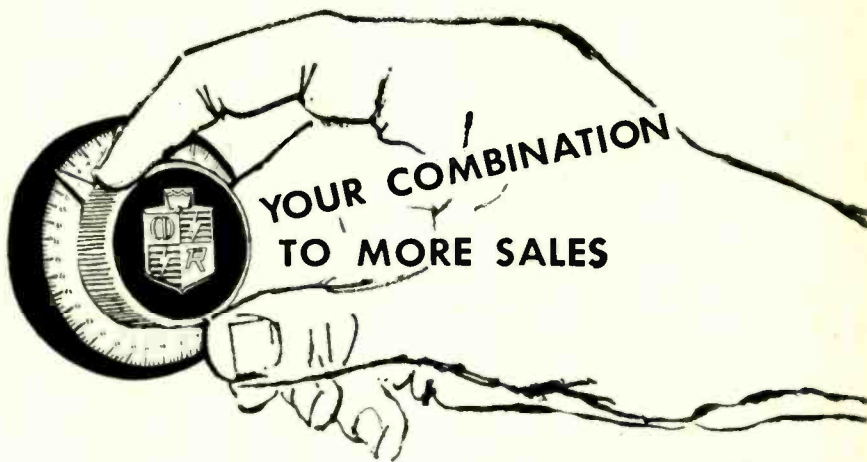

THE COMPLETE LINE

... a model for every need... whatever the application there is a CDR Rotor that meets the situation best!

PRE-SOLD FOR YOU!

The greatest coverage and concentration of full minute spot announcements on leading TV stations in every major rotor market is working for YOU...pre-selling your customers!



CORNELL-DUBILIER
SOUTH PLAINFIELD, N. J.



THE RADIART CORP.
CLEVELAND 13, OHIO



FORD

FOR '57...

CBS TUBES

FOR '57...

CBS TRANSISTORS

FOR '57



A new, sleek, long, low '57 Ford with the touch of tomorrow. Under the dash, a fine new Ford radio receiver, transistor-powered for the ultramodern touch. And in it, new low-voltage mobile radio tubes by CBS . . . new power output transistor by CBS.

That's only natural. CBS pioneered the first auto radio tube kit. CBS has been a major supplier of tubes to Ford and other leading auto radio set manufacturers for years. And now CBS offers tubes and transistors for the new "hybrid" auto radio receivers.

Whatever you need for auto radio replacements — tubes or transistors — old, modern, or ultramodern — follow the leading set manufacturers . . . replace with CBS.

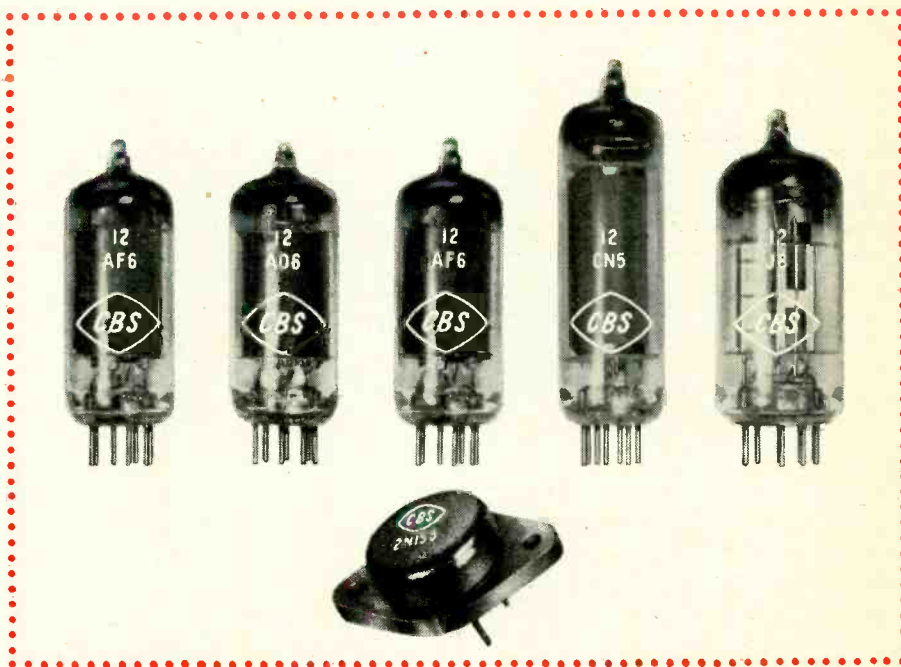

tubes • semiconductors

*Reliable products
through Advanced-Engineering*

CBS-HYTRON

Danvers, Massachusetts

A Division of Columbia Broadcasting System, Inc.

Electronics Boom Seen

Need For Television Technicians To Rise

Industry Warned About Shortage Of Trained Men

TV SALES SET NEW RECORD

Sylvania Head Expects Huge Electronic Gains

Transistor Radios Developed

RCA HEAD PREDICTS SALES BOOM FOR COLOR TV SETS

VETERANS - - NON-VETERANS

Get Into The Field That's Making Headlines



L. C. Lane, B.S., M.A.
President, Radio-Television Training Association
Executive Director, Pierce School of Radio & Television

All over the nation the Television-Radio-Electronics industry is making News — News that means opportunity for YOU. You can cash in on the headlines.

I WILL TRAIN YOU AT HOME FOR A TOP-PAY JOB IN TELEVISION

I will prepare you for a spot in America's fastest-growing industry. You can become a trained technician in your spare time without giving up your present job or social life. No experience needed.

LEARN BY DOING

Combination Voltmeter-Ammeter-Ohmmeter



C-W Telephone Transmitter

Super-Het Radio Receiver

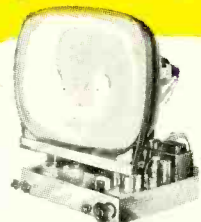

Public Address System

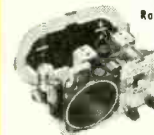

AF-RF Signal Generator

As part of your training I give you the equipment you need to set up your own home laboratory and prepare for a top-pay job or set up your own business. You build and keep an Electromagnetic TV RECEIVER designed and engineered to take any size picture tube up to 21-inch. (10-inch tube furnished. Slight extra cost for larger sizes.) . . . also a Super-Het Radio Receiver, AF-RF Signal Generator, Combination Voltmeter-Ammeter-Ohmmeter, C-W Telephone Transmitter, Public Address System, AC-DC Power Supply. Everything supplied, including all tubes.

STUDY NEWEST DEVELOPMENTS

My training covers all the latest developments in the fast-growing Television-Radio-Electronics industry. You learn about FM — RADAR — COLOR TV — TRANSISTORS — PRINTED CIRCUITS, etc.

CHOOSE FROM FOUR COMPLETE COURSES covering all phases of Radio, FM and TV

1. Radio, FM and Television Technician Course—no previous experience needed.
2. FM-TV Technician Course—previous training or experience in radio required.
3. TV Studio Technician Course—advanced course for trained men.
4. Color TV Technician Course—Includes latest color TV circuits.

EXTRA TRAINING IN NEW YORK CITY AT NO EXTRA COST!

After you finish your home study training in Course 1 or 2 you can have two weeks, 50 hours, of intensive Lab work on modern electronic equipment at our associate resident school, Pierce School of Radio & Television. THIS EXTRA TRAINING IS YOURS AT NO EXTRA COST WHATSOEVER!

FCC COACHING COURSE

Important for BETTER-PAY JOBS requiring FCC license! You get this training AT NO EXTRA COST! Top TV jobs go to FCC-licensed technicians.

VETERANS

My School fully approved to train Veterans under new Korean G. I. Bill. Don't lose your school benefits by waiting too long. Write discharge date on coupon.

Radio-Television Training Association

52 EAST 19th STREET • NEW YORK 3, N. Y.

Licensed by the State of New York • Approved for Veteran Training

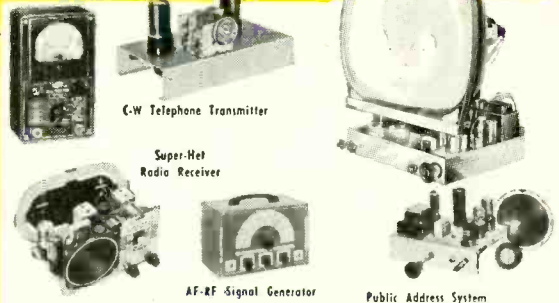

Sylvania Now Sponsoring RTTA's Color TV Technician Course
One of the nation's largest electronics manufacturer's and marketer's, Sylvania Electric Products, Inc. in its continuing effort to cooperate with independent service dealers is now sponsoring the RTTA Color Television Technician Course. The Color Television Technician Course is being made available to authorized Sylvania Dealers throughout the 48 states who are interested in expanding their knowledge and experience in Color TV servicing.

FREE I'll send you my new 40-page book, "How to Make Money in Television-Radio-Electronics," a Free sample lesson, and other literature showing how and where you can get a top-pay job in Television.

MAIL THIS COUPON TODAY!

Mr. Leonard C. Lane, President

RTTA

Dept. RE-12C, 52 East 19th Street, New York 3, N. Y.

Dear Mr. Lane: Send me your NEW FREE BOOK, FREE SAMPLE LESSON, and FREE aids that will show me how I can make TOP MONEY IN TELEVISION. I understand I am under no obligation.

(PLEASE PRINT PLAINLY)

Name _____ Age _____

Address _____

City _____ Zone _____ State _____

- Color TV Course
- Radio-FM-TV Technician Course
- FM-TV Technician Course
- TV Studio Technician Course

VETERANS!
Write discharge date

NO OBLIGATION!

THE HOW AND WHY

OF THE WORLD'S PUREST SILICON

The purification of silicon by Bell Laboratories metallurgists has been richly rewarding. Their original research in this field revealed the chemical factors that control semiconductors; it was a major advance leading to Bell Laboratories' invention and development of transistors and the Bell Solar Battery. Now they have devised a simple but highly effective way to remove boron—one of the most difficult impurities to extract from silicon.

During refining, a stream of hydrogen and water vapor is kept flowing past the silicon. As the water vapor passes over the liquid silicon, it seizes boron atoms, forming boron oxide. The oxide is then pulled away to condense on the wall of the refining tube which is cooled by a water stream. Result of refining: boron and other harmful impurities are reduced to less than one part in 10,000,000,000.

The new silicon is being used to develop still better transistors and rectifiers for telephony. It is another example of how Bell Laboratories metallurgists help open the way to improved telephony.

BELL TELEPHONE LABORATORIES



World center of communications research and development

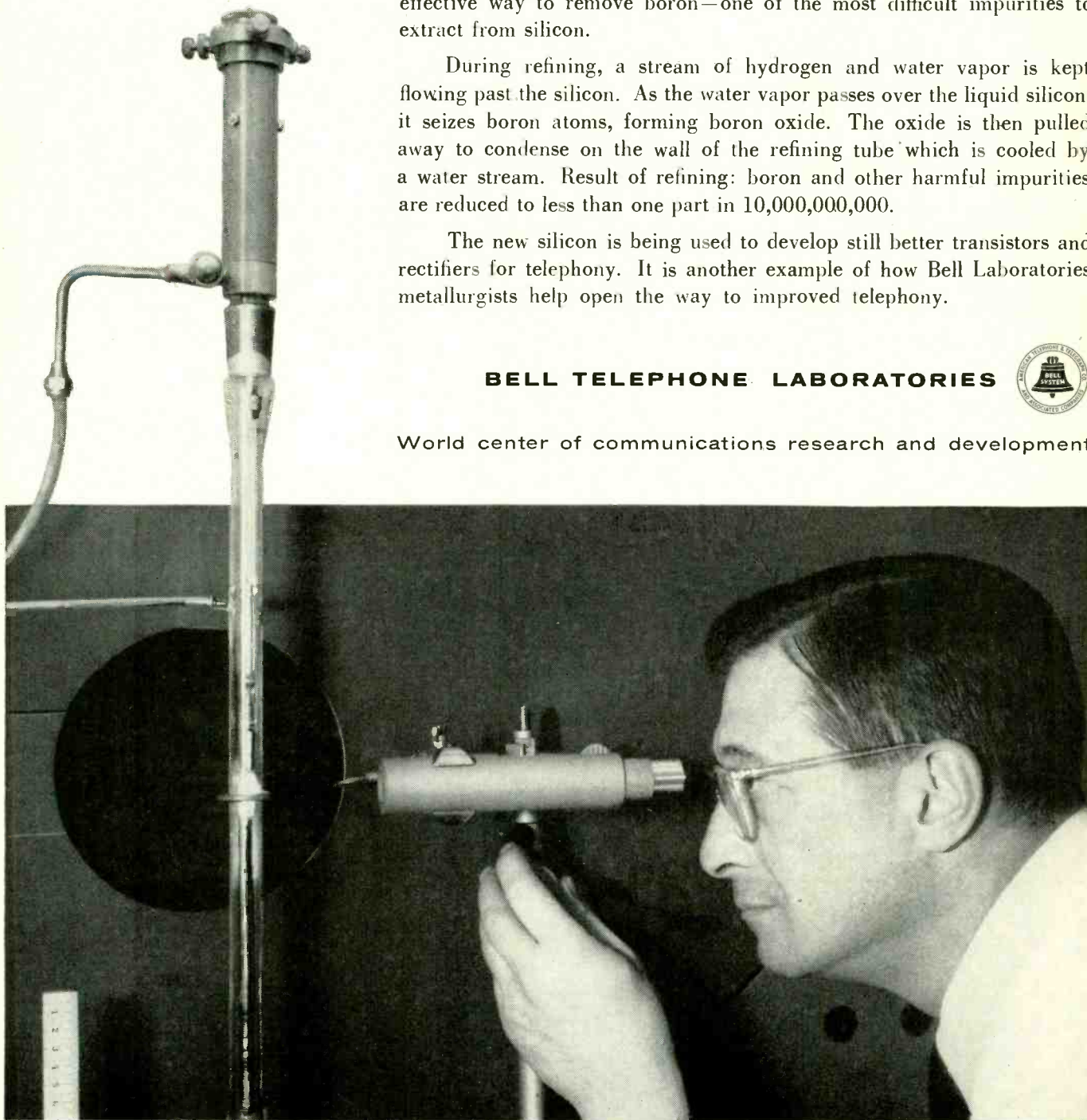

Metallurgist Henry C. Theuerer, M.A. in Chemistry, Columbia, watches a molten zone in a silicon rod under purification. Mr. Theuerer's most recent achievement was development of water-vapor treatment for removal of boron.

RCA offers you the
 finest training
 at home in
 Radio-TV
 electronics,
 TV servicing,
 Color TV

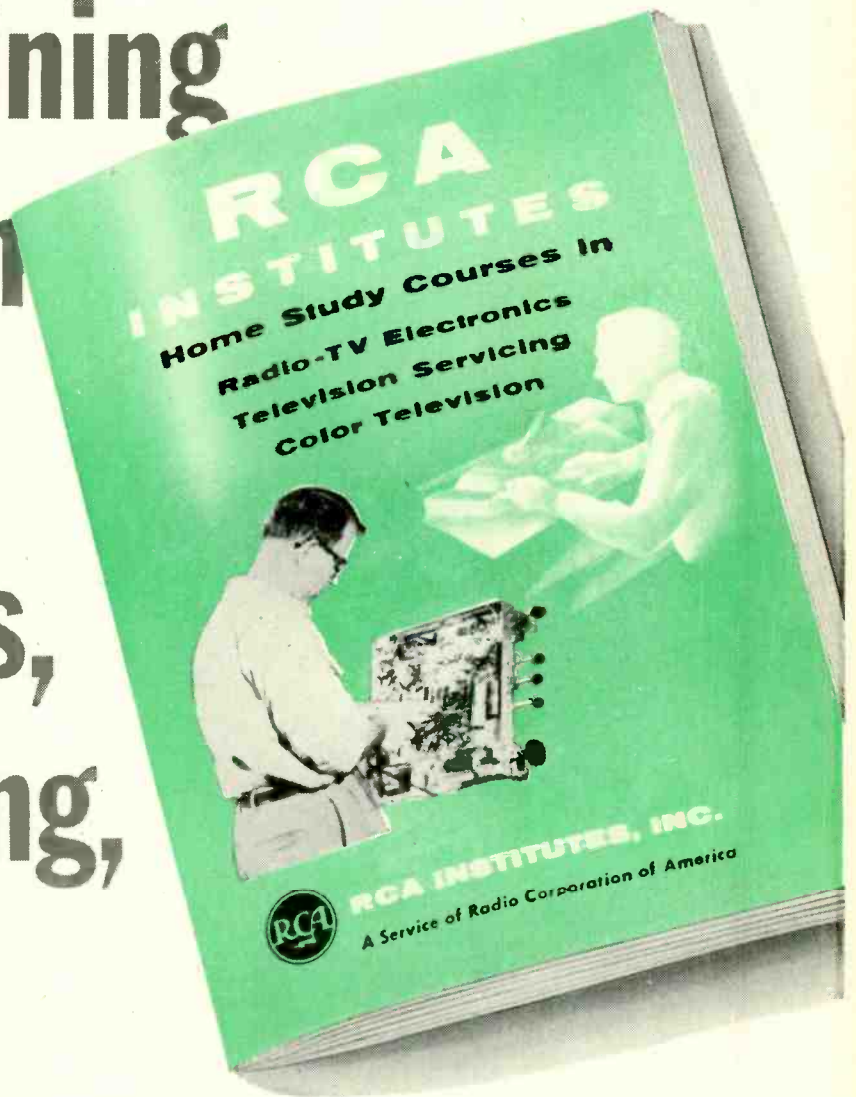

SEND FOR THIS FREE BOOK NOW!

The instruction you receive and equipment you get (and keep) will start you on your way. Pay-as-you-learn. You pay for only one study group at a time. This 52 page book contains complete information on Home Study Courses for the beginner and the advanced student.



RCA INSTITUTES, INC.
 A SERVICE OF RADIO CORPORATION OF AMERICA
 350 WEST FOURTH STREET, NEW YORK 14, N.Y.

RCA Institutes, Inc., Home Study E-126,
 350 West Fourth Street New York 14, N. Y.
 Without obligation, send me FREE CATALOG
 on Home Study Courses in Radio, Television
 and Color TV. No salesman will call.

Name
 Please Print
 Address
 City Zone State

**VETERANS
 KOREAN G-I**
 Check here
 PL550



Make this a Christmas long remembered— with full fidelity listening pleasure for the entire family



Norelco *F.R.S.
speakers are available
5", 8" or 12" sizes in standard impedances.
Priced from \$6.75 to \$59.98
Blue prints are available for the
do-it-yourself enclosure builder.

You will hear a remarkable difference in the clarity of Norelco *Full Resonance Speakers. In a single speaker, twin-cones reproduce low frequencies, middle range, as well as the higher frequencies extending beyond the audible range—without distortion.

WHY ARE NORELCO FRS SPEAKERS SO EXCEPTIONAL?

They have incorporated a number of technical refinements which are evident the moment you listen. The air gap has been made long so that the coil is completely enclosed in an even magnetic field at all times. A copper ring has been fitted into the deep air gap to keep the

voice coil impedance constant over the whole frequency range: this avoids incorrect matching. High flux densities are obtained through the use of "Ticonal" magnet steel.

Norelco speaker-matched enclosures are scientifically designed acoustical boxes which enhance the exceptional tone qualities of FRS speakers; bringing out their true performance values.

Norelco FRS Speaker Enclosures are available in three sizes to match the characteristics of the speaker in use. Supplied in either mahogany or blond, these enclosures incorporate a removable base permitting the enclosures to be placed horizontally or vertically to suit any room arrangement or decor.



ADD TO...and improve any sound system with **Norelco *FULL RESONANCE SPEAKERS**

Write today to Dept. D-12 for brochures and prices of these unique speakers.

NORTH AMERICAN PHILIPS CO., INC., 100 E. 42nd Street, New York 17, N. Y.

**NEW! COLOR and Black-&-White
LAB & TV 5" OSCILLOSCOPE #460
KIT \$79.95. Wired \$129.50**

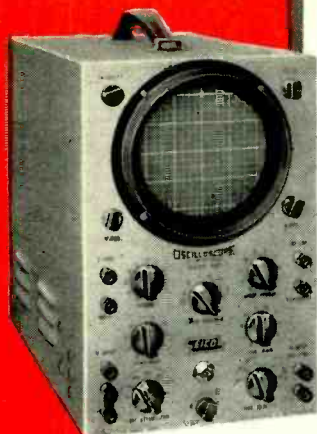

The FINEST professional 5 mc wide-band scope value. Ideal for research, h-f & complex waves, plus Color & Monochrome TV servicing. Flat from DC to 3.58 mc ± 1 db (color burst freq.), flat DC to 4.5 mc +1, -3 db. Vert. sens. 25 rms mv/in. Vert. Z 3-megs. Has the following outstanding features not found in scopes up to several times its price, kit or wired:

VERTICAL AMPLIFIER: direct-coupled (DC) thruout to eliminate l-f phase shift; push-pull thruout for negligible distortion; K-follower coupling between push-pull pentode stages for extended h-f resp. (minimizes h-f phase shift, extends useful resp. to 10 mc); full-screen undistorted vert. defl; 4-step freq-compensated decade step attenuator up to 1000:1. **SWEEP CIRCUIT:** perfectly linear sweeps, 10 cps - 100 kc (ext. cap. for down to 1 cps); pre-set TV vert. & hor. positions (30 & 7875 cps); automatic sync. ampl. & limiter eliminates sync amplitude adj. **PLUS:** direct or cap. coupling; bal. or unbal. inputs; edge-lit engraved lucite graph screen; dimmer; anti-glare filter; bezel fits std photo equip. **OTHER IMPORTANT FEATURES:** High intensity trace CRT. Finest sq. wave resp. (.06 usec rise time). Push-pull hor. ampl., flat to 400 kc, sens. 0.6 rms mv/in. Built-in voltage calibration. Intensity mod. Sawtooth & 60 cps outputs. Astigmatism control. Retrace blank-

ing. Instant, drift-free full-screen vert. positioning & 2X full-screen hor. positioning. Bal., cal., astig. adj. externally accessible. 5U1 CRT, 2-6AU8, 2-6CB6, 1-12AU7A, 2-6J6, 1-6AX5, 1-1V2. Deep-etched satin aluminum panel, rugged grey wrinkle steel cabinet. Designed for easy building at home with no special equipment. 13" x 8 1/2" x 16". 30 lbs.

SCOPE DIRECT PROBE* #PD: KIT \$2.75. Wired \$3.95. Eliminates stray-pick-up & signal re-radiation.

SCOPE DEMODULATOR PROBE* #PSD: KIT \$3.75. Wired \$5.75. Demodulates AM carriers between 150 kc and 250 mc.

SCOPE LOW CAPACITY PROBE* #PLC: KIT \$3.75. Wired \$5.75. For signal tracing in high frequency, high impedance & wide-band circuits (as in TV) without distortion from overloading or frequency discrimination.

for COLOR and Monochrome TV servicing

**New! PEAK-to-PEAK VTVM #232
& UNI-PROBE (pat. pend.)
KIT \$29.95. Wired \$49.95**



UNI-PROBE: exclusive with EICO! Terrific time-saver! Only 1 probe performs all functions—a half-turn of probe-tip selects DC or AC-Ohms.

The new leader in professional peak-to-peak VTVMs. Latest circuitry, high sensitivity & precision, wide ranges & versatility. Calibration without removing from cabinet. New balanced bridge circuit. High Z input for negligible loading. 4 1/2" meter, can't-burn-out circuit. 7 non-skip ranges on every function. 4 functions: +DC Volts, -DC Volts, AC Volts, Ohms.

Uniform 3 to 1 scale ratio for extreme wide-range accuracy. Zero center. One zero-adj. for all functions & ranges. 1% precision ceramic multiplier resistors. Measure directly peak-to-peak voltage of complex & sine waves: 0.4, 14, 42, 140, 420, 1400, 4200. DC/RMS sine volts: 0-1.5, 5, 15, 50, 150, 500, 1500 (up to 30,000 v. with HVP probe, & 250 mc with PRF probe). Ohms: 0.2 ohms to 1000 megohms. 12AU7, 6AL5, selenium rectifier; xfmr-operated. 8 1/2" x 5" x 5". Deep-etched satin aluminum panel, rugged grey wrinkle steel cabinet. 7 lbs.

**New! DELUXE PEAK-to-PEAK VTVM #249
with 7 1/2" METER & UNI-PROBE (pat. pend.)
KIT \$39.95. Wired \$59.95**

All the advanced & exclusive features of #232—PLUS the extra convenience and readability of its big 7 1/2" meter. Your ideal bench instrument.

VTVM RF PROBES* #PRF-11 or PRF-25: KIT \$3.75. Wired \$4.95. Accuracy $\pm 10\%$. Use with any 11 or 25 megohm VTVM.

VTVM HV PROBE #HVP-2: Wired \$4.95. Complete with multiplier resistor. Measures up to 30 kv with any VTVM or 20,000 ohms/volt VOM.

Calibration without removing from cabinet.

*Only EICO Probes have all these features: fully shielded; rugged terminal board parts mounting; shock-mounted housing construction; swivel action; color-coding; easy panel accessibility.



150 kc to 435 mc
with ONE generator!

**New! RF SIGNAL-GENERATOR #324
KIT \$26.95. Wired \$39.95**

for COLOR and Monochrome TV servicing

New wide-range, stable generator — better value than generators selling at 2 or 3 times its cost! Ideal for: IF-RF alignment, signal tracing & trouble-shooting of TV, FM & AM sets; marker gen.; 400 cps audio testing; lab. work. 6 fund. ranges: 150-400 kc, 400-1200 kc, 1.2-3.5 mc, 3.5-11 mc, 11-37 mc, 37-145 mc; 1 harmonic band 111-435 mc. Freq. accurate to $\pm 1.5\%$; 6:1 vernier tuning & excellent spread at most important alignment freqs. Etched tuning dial, plexiglass windows, edge-lit hairlines. Colpitts RF osc., directly plate-modulated by K-follower for improved mod. Variable depth of int. mod. 0-50% by 400 cps Colpitts osc. Variable gain ext. mod. amplifier: only 3.0 volts needed for 30% mod. Turret-mounted coils slug-tuned for max. accuracy. Fine & Coarse (3-step) RF attenuators. RF output 100,000 uv; AF sine wave output to 10 volts. 50-ohm output Z. 5-way jack-top binding posts for AF in/out; coaxial connector & shielded cable for RF out. Tubes: 12AU7, 12AV7, selenium rectifier; xfmr-operated. Deep-etched satin aluminum panel, rugged grey wrinkle steel cabinet. 8" x 10" x 4 3/4". 10 lbs.

The specs are the proof...

**4 NEW BEST BUYS
by EICO**

**COMPLETE
with Preamp, Equalizer and Control Section
New! 20-WATT Ultra-Linear Williamson-
type HIGH FIDELITY AMPLIFIER #HF20
KIT \$49.95. Wired \$79.95**

A low-cost, complete-facility amplifier of the highest quality that sets a new standard of performance at the price, kit or wired. Every detail, down to the etched, brushed solid brass control plate, is of the fine quality EICO is famous for.

Rated power output: 20 watts (34 w peak). **IM distortion** (60 cps: 6 kc/4:1) at rated power: 1.3%. **Mid-band harmonic distortion** at rated power: 0.3%. **Maximum harmonic distortion between 20 and 20,000 cps at 1 db under rated power:** approx. 1%. **Power response (20w):** ± 0.5 db 20-20,000 cps; ± 1.5 db 10-40,000 cps. **Frequency response (1/4 w):** ± 0.5 db 13-35,000 cps; ± 1.5 db 7-50,000 cps.

5 feedback equalizations for LP's & 78's including RIAA. Variable turnover feedback tone controls do not affect volume & permit large boosts or cuts at either end of audio spectrum with mid-freqs. unaffected. Loudness control & separate level set control on front panel. Low Z output to tape recorder. 4 hi-level switched inputs: tuner, tv, tape, auxiliary (xtal/ceramic phono or 2nd tuner); 2 low-level inputs for proper loading with all leading magnetic, FM & quality xtal cartridges. Hum bal. control. Extremely fine output transformer has interleaved windings, tight coupling, careful balancing & grain-oriented steel. 8 1/2" x 15" x 10". 24 lbs.

These amazing EICO values are NOW IN STOCK at your nearest distributor. Examine them side-by-side with ANY competitor. You'll see for yourself why indeed EICO is your BEST BUY. Fill out coupon on reverse page.



TURN PAGE FOR MORE EICO VALUES

84 Withers Street, Brooklyn 11, New York

Prices 5% higher on West Coast.

**the specs are
the test that tells
who's best!**

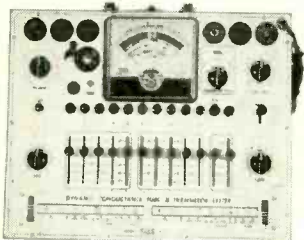

for COLOR & Monochrome
TV servicing

**NEW! DYNAMIC
CONDUCTANCE TUBE &
TRANSISTOR TESTER #666**
KIT \$69.95 WIRED \$109.95

Unexcelled testing thoroughness & accuracy. Checks transistor collector current & Beta using internal dc power supply. Tests all receiving tubes including subminiatures (& Color & Monochrome tv pic tubes with accessory adapter). Composite indication of mutual conductance, plate conductance, & peak emission. Simultaneous sel. of any 1 of 4 combinations of 3 plate, 3 screen, & 3 ranges of control grid voltage. Grid voltage variable over 3 ranges with 5% accurate pot. New series-string voltages for 600, 450 & 300 ma types. 5 ranges meter sens. with 1% precision shunts & 5% accurate pot. 10 SIX-position lever switches for free-point connection of every tube pin or cap. 10 pushbuttons for rapid insert of any tube element in leakage circuit & speedy sel. of individual tube sections. Direct reading of inter-element leakage in ohms. New gear-driven roll-chart. Steel case with cover & handle. Sensitive 200 μ a meter.

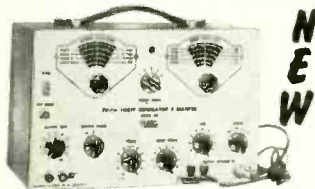

NEW

for COLOR & Monochrome
TV servicing
**TV-FM SWEEP GENERATOR
& MARKER #368**
KIT \$69.95 WIRED \$119.95

The FINEST service instrument of this type ever offered in either kit or wired form at ANY price! Outstanding ease & accuracy in FM & TV (including Color) alignment. Entirely electronic sweep circuit with accurately biased Increductor: superb linearity on both sides of selected center freq. Newly-designed AGC circuit automatically adjusts osc. for max. output on each band with min. amplitude variations. Sweep gen. range 3-216 mc in 5 OVERLAPPING FUND. BANDS. Sweep width continuously variable from 0-3 mc lowest max. deviation to 0-30 mc highest max. deviation. Variable marker gen. range from 2-75 mc in 3 FUND. BANDS plus a calibrated harmonic band (60-225 mc). Variable marker calibrated with int. xtal marker gen. 4.5 mc xtal included. Ext. marker provision. Double pi line filter. Edge-lit hairlines eliminate parallax.

Turn page for other EICO ad

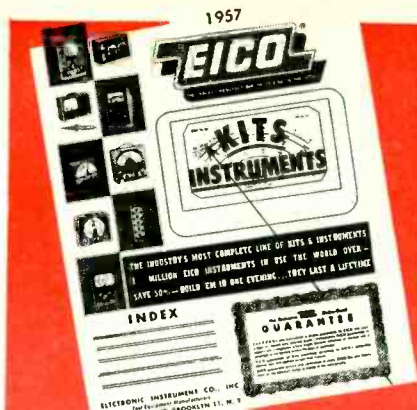

**FREE 1957
EICO CATALOG!**

Tells you how to SAVE 50% on
your test equipment costs!



TUBE TESTER #625
KIT \$34.95
Wired \$49.95
• tests 600 mil series string type tubes
• illuminated roll-chart

Pix Tube Test Adapter\$4.50



New! GEIGER COUNTER #803
KIT \$19.95
Wired \$29.95
(less batteries)
Professional, all-electronic, sensitive, rugged—at lowest cost! Indicates by neon lamp & headphone clicks.

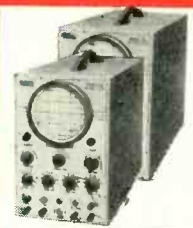

5" PUSH-PULL OSCILLOSCOPE #425
KIT \$44.95
Wired \$79.95
7" PUSH-PULL OSCILLOSCOPE #470
KIT \$79.95
Wired \$129.50



VACUUM TUBE VOLTMETER #221
KIT \$25.95
Wired \$39.95
DELUXE VTVM #214 (7 1/2" METER)
KIT \$34.95
Wired \$54.95



RF SIGNAL GENERATOR #320
KIT \$19.95
Wired \$29.95
150 kc-34 mc, calibrated harmonics to 102 mc. Pure or mod. RF, & Colpitts osc. 400 cps sine outputs.



NEW! REDI-TESTER #540
KIT \$12.95
Wired \$15.95
Multi-range ac/dc voltmeter, ammeter, ohmmeter, wattmeter, leakage checker for home & auto repairs.



#944 FLYBACK TRANSFORMER & YOKE TESTER
KIT \$23.95
Wired \$34.95
• fast check all flybacks & yokes in or out of set.
• spots even 1 shorted turn!

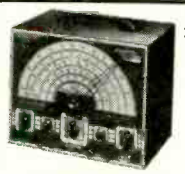

Range 500 kc-228 mc on fund. Cont. sweep width control, 0-30 mc.
KIT \$34.95
Wired \$49.95
TV/FM SWEEP GENERATOR #360
5MC-4.5MC CRYSTAL\$3.95 ea.



1% accuracy on all 7 ranges. Range 75 kc-150 mc. Volt reg.
KIT \$39.95
Wired \$59.95
DELUXE RF SIGNAL GENERATOR #315

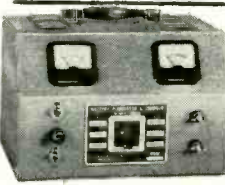

Sep. volt-meter & ammeter
KIT \$29.95
Wired \$38.95
6V & 12V BATTERY ELIMINATOR & CHARGER #1050

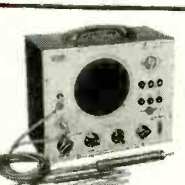

Sep. hi-gain RF & lo-gain audio inputs. Special noise locator. Calibrated wattmeter.
KIT \$24.95
Wired \$39.95
DELUXE MULTI-SIGNAL TRACER #147

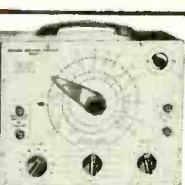

Reads 0.5 ohms -500 megs, 10 mmfd-5000 mfd power factor.
KIT \$19.95
Wired \$29.95
R-C BRIDGE & R-C-L COMPARATOR #950B



NEW!

HI-FI PREAMPLIFIER #HF-61
KIT \$24.95. Wired \$37.95. With Power Supply: KIT \$29.95. Wired \$44.95
Feedback circuitry thruout! Preamplifier, tone controls, scratch & rumble filters, K-follower output.



20,000 Ohms/Volt
MULTIMETER #565
KIT \$24.95
Wired \$29.95



1000 Ohms/Volt
MULTIMETER #536
KIT \$12.90
Wired \$14.90

VTVM PROBES	KIT	Wired
Peak-to-Peak	\$4.95	\$6.95
RF	\$3.75	\$4.95
High Voltage Probe-1		\$6.95
High Voltage Probe-2		\$4.95
SCOPE PROBES		
Demodulator	\$3.75	\$5.75
Direct	\$2.75	\$3.95
Low Capacity	\$3.75	\$5.75

For FREE 1957 catalog, mail coupon NOW!



84 Withers St. • Brooklyn 11, N. Y.

Prices 5% higher on West coast and subject to change without notice. ©56

EICO, 84 Withers Street
Brooklyn 11, New York C-12

Send FREE 1956 Catalog and name of neighborhood EICO jobber.

Name.....

Home Address.....

City.....Zone.....State.....

Occupation.....

Over a Decade of Know-How & Value Leadership in Kits & Instruments — Over 1 Million Sold to Date!

FIFTY YEARS OF THE VACUUM TUBE*

... *The Most Outstanding Milestone in Radio and Electronics* ...

THE year 1956 marks the 50th anniversary of the amplifying radio vacuum tube—Dr. Lee de Forest's three-element audion. While de Forest invented audions before 1906, they did not contain the all-important and vital grid. His patent application of this tube came a bit later (Jan. 29, 1907), but 1906 was the actual date of the birth of the modern vacuum tube.

And what a milestone it proved to be in the history of radio! Imagine for a moment that the audion had not been invented: There would have been no electronics, no radios, no broadcasting, no ocean phone, no talking motion pictures, no amplifiers, no radar, no television, no klystrons, no cyclotrons that made possible fission and atomic energy, no radio-guided missiles—and hundreds of other radio wonders, plus myriads of new ones to come. Truly the progress of modern radio and electronics would have been set back for almost a generation.

It will always remain a vivid fact which we must never forget: de Forest gave us these priceless gifts—gifts that changed our lives and our habits, annihilated distances, carried the spoken word and music through all space on this planet—as well as into outer space—a reality which in time will unite humanity as nothing has ever done before.

The uninformed always will parrot the now-hackneyed cliché: "If he hadn't invented the vacuum tube, somebody else would have." Maybe so—but it was de Forest who did it first.

De Forest never was the "lucky" type of inventor who just stumbled accidentally upon an epoch-making invention—as for instance Dr. Roentgen's discovery of the X-ray. No, he literally "sweated it out." Fortunately, he was gifted not only with a never-to-be-satisfied curiosity but with an imagination of heroic dimensions.

During his first semester at Yale University, one of the professors gave a lecture which was to change the entire course of de Forest's life. The lecture was on the electromagnetic wave theory with a demonstration of Heinrich Hertz' experiments. This caused such a flare-up in the young student that he made this entry in his notebook:

"I shall learn all about the atom . . . shall guess its shape . . . shall postulate its causes and attractions . . . and I SHALL INVENT THE REASON FOR IT."

It has been my great pleasure to have known Lee de Forest since 1906—over 50 years. I have come to know him very well, and I have had many opportunities to study him at close range over the years. I have been fortunate to have known Edison, Tesla and other inventors equally well, and therefore believe myself qualified to judge the outstanding qualities of such men.

One cannot be long in de Forest's company before realizing that among his greatest characteristics is his inherent modesty. He speaks in measured, quiet phrases. His unusually deep-set eyes proclaim the man of science, the indefatigable worker, the type of man who never gives up a quest in search of light and truth. His complete disregard of his attire, his frugal living, his constantly preoccupied

air, point to his tireless toil and zest for new worlds to conquer. Indeed, at 83, he still keeps busy at his Los Angeles research laboratory.

Financial transactions bore de Forest to distraction—and unfortunately for him the world has seen fit to take advantage of this: a pittance for his vacuum tube, his regeneration invention, his radiophone (broadcasting) as well as dozens of his more than two hundred inventions.

Harassed by patent suits against him and countersuits which he had to bring against others, the comparatively modest amount of money that he received for his inventions soon vanished. Once, because he was so rash as to tell a Federal court that with his radiophone a man would soon be able to talk across the ocean, the Father of Radio almost went to jail! If not for the pleas of a good attorney, he would have been imprisoned for his temerity in predicting modern broadcasting!

Nothing ever came easy to the great inventor. The invention of the audion was no exception. It was an epic in frustration, in dogged plodding against seemingly insuperable, mountainous difficulties. There are too many witnesses who worked with him and who certified how he started with his Welsbach gas-flame audion and step by step, through literally thousands of separate experiments, finally battled himself to the three-element grid audion. In spite of all this evidence, there are even today jealous, narrow-minded intolerants who say with total disregard for the facts, "Oh, de Forest, he just stuck a grid into the Fleming valve!" This is like saying, "The Wright Brothers flew, because they stuck a propeller on an old kite."

It is eminently befitting that the *De Forest Pioneers, Inc.*, a membership organization of Lee de Forest's friends and contemporaries, who had been associated with him in various ways during the days of the audion, should honor him on the 50th anniversary of his great invention.

This was done on the morning of Nov. 12, 1956, when a large bronze plaque bearing a portrait of Dr. Lee de Forest, with appropriate wording, was unveiled. The locale was the site of the old Parker Building, on the southeast corner of 19th Street and Fourth Avenue, New York City. It was in this building that he invented the grid audion, the first three-electrode vacuum tube, 50 years ago.

The plaque was unveiled by Rear Admiral William Halsey, USNR, in the presence of Admiral Ellery W. Stone, USN, president of De Forest Pioneers, Inc.; many members of the society; Brig. Gen. David Sarnoff, chairman of the board of the Radio Corporation of America, and other notables.

Let all of us—the entire radio-electronic fraternity—congratulate Dr. Lee de Forest on the 50th anniversary of his epoch-making invention—the audion. Then let us wish him continuous good health, a long and happy life and many new laurels.

—H. G.

*Parts of this article appeared in our editorial "De Forest—Father of Radio," in the January, 1947, issue of this magazine.

The Editors wish you a Happy Christmas and a Wonderful New Year

STABILIZING FEEDBACK AMPLIFIERS

*Types of oscillation,
conditions producing them,
the stability criterion*

By NORMAN H. CROWHURST

TO AVOID confusion between kinds of instability let's start by defining the different things that can constitute instability. The one most evident is continuous oscillation. In feedback amplifiers, particularly, this usually occurs outside the audio spectrum, either at a very high or very low frequency.

If the high-frequency oscillation is of sufficient amplitude to load fully some or all amplifier stages, it results in *high-frequency blocking*. This is characterized by the output of the amplifier seeming exceptionally quiet until one tries to pass an audio signal through it. Then the audio signal breaks through in varying degrees, according to the strength of the high-frequency blocking, in an extremely distorted form. The sound resembles what one would imagine it to be like if the audio voltages had to break down a spark gap before they got through. Low-intensity sounds don't get through at all, but large ones break the gap down and manage to carry some other small ones through with them. Then, when the level drops, everything becomes quiet again. The waveform, as seen on a scope, is shown in Fig. 1.

Low-frequency oscillation results either in audible motorboating (since the oscillation is not sinusoidal), the variety most easily recognized, or in an approximately sinusoidal low-frequency waveform which is inaudible because it is subsonic.

However, the latter may result in intermodulation distortion because it carries peaks of the true audio signal beyond the output limit of the amplifier, as shown at Fig. 2. If you use an ac input to a scope, the real cause may not

be evident because the blocking capacitor may stop the low-frequency component from registering on the scope displacement. It may just be noted that the clipping point on the top and bottom of the wave seems to fluctuate in some erratic manner.

A way in which this form of instability can be spotted, sometimes, is by taking dc readings at various points in the amplifier: plate, cathode, etc. The dc readings will go up and down with a slow fluctuation at the same rate as the low-frequency instability. And instead of moving with a ticking or sawtooth waveform, which is responsible for motorboating, the instrument pointer will wave up and down sinusoidally.

So much for the continuous types of instability. They are more definite than the others. The remaining kinds are parasitic and conditional oscillation.

Parasitic oscillation

This occurs at some point on a waveform and may be hard to detect as an entity audibly because the parasitic frequency is inaudible—it does not show up audibly on a sinusoidal wave. However, it may well interfere with some of the higher frequencies on the same wave and produce a form of intermodulation distortion that sounds muddy. The waveform for sine-wave input looks on the scope like Fig. 3. The amplifier generally breaks into oscillation at one point on a large-amplitude waveform and then dies out.

Conditional oscillation

The third variety of instability can be called conditional oscillation. There are two ways this can be caused and

the results can be slightly different—although there may be cases where this difference is so marginal that it cannot be used to discover which kind of instability is occurring.

One way is to run into overload. This means that the amplifier behaves normally all the while the program level stays inside the clipping point. But as soon as the program runs into clipping, the amplifier bursts into oscillation and nothing will stop it except turning the unit off and starting over again.

The second way usually differs in the means by which it is initiated—not by going up to the clipping level, but by a somewhat smaller signal (but not a very low one). This means that the amplifier may be all right while playing very quietly. But as soon as a slightly louder program is passed through it, oscillation begins.

Superficially there is not much difference between these forms and in practical cases also the margin may be narrow. *But in cause there are two different cases here!* To explain these forms of instability in feedback amplifiers and find ways and means of curing them, we need to understand why they occur.

Stability criterion

A feedback amplifier is stable provided that the feedback does not get to being positive and of sufficient amplitude to cause oscillation at any frequency within the range of the amplifier. Considering the overall gain around the feedback loop, rolloffs are bound to occur at the end of the response—in direct-coupled amplifiers at the high-frequency end only; in the

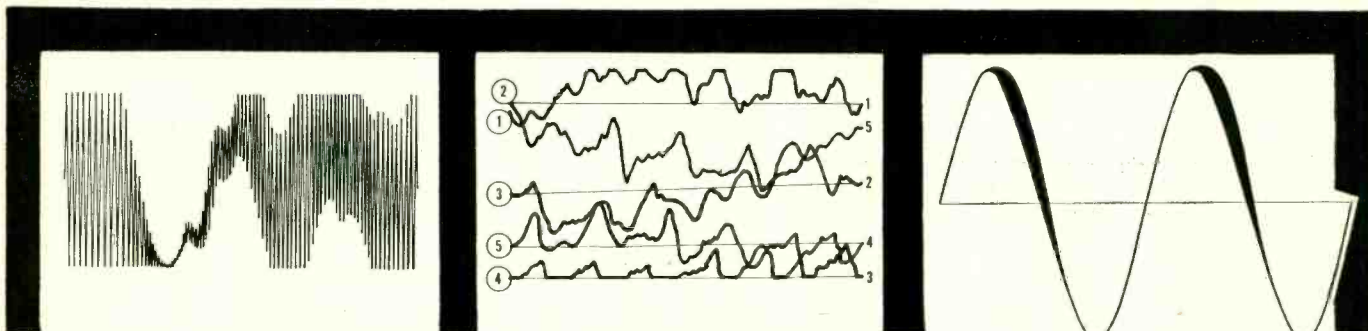

Fig. 1, left—High-frequency blocking. Fig. 2, center—Scope display when an amplifier oscillates inaudibly at a very low frequency. Circled numbers show start of trace and corresponding uncircled numbers show the trace ends. Fig. 3, right—sine-wave input produced by parasitic oscillation.

more usual R-C-coupled amplifiers at both ends of the response. Associated with the progressive attenuation that these rolloffs introduce is a phase delay at the high-frequency end and a phase advance at the low-frequency end.

The problem in achieving stability is one of insuring that the attenuation around the loop—that is, through the amplifier and back through the feedback to the input point again—becomes sufficient so that the fed-back signal is less than the input signal before the phase shift reaches 180°.

When the phase shift reaches 180°, the feedback has changed from negative completely over to positive so that, if the fed-back signal is equal to the input signal, we have the condition necessary to maintain oscillation. To determine whether this happens at any frequency we can draw the gain and phase characteristics of the amplifier loops (Fig. 4) and spot the point where the gain has dropped to unity, then check on the lower diagram to see that the phase is less than 180°. Or else, we can spot the point where the phase reaches 180° and check to see that the overall gain has dropped to less than unity. (A margin of about 30°, at unity gain, is desirable for excellent stability.) This entails looking at two curves, so the Nyquist diagram is a convenient way of presenting this information on a single picture.

Nyquist diagram

This consists of plotting a polar curve of the response so that the distance of a point on the curve from the origin represents the gain around the loop at any particular frequency and the angle of this line from the origin represents the phase shift. This presentation is illustrated in Fig. 5.

Using this form of presentation the condition for stability can be expressed simply by stating that the curve must pass inside the point representing a gain of unity in the negative direction, as shown at Fig. 5-a. (Note that gain in Fig. 5 is a straight voltage ratio, whereas it is expressed in decibels in Fig. 4.)

If the curve passes outside this point, as at Fig. 5-b, the amplifier is unstable because the amount of feedback at 180° phase shift is greater than unity. Hence the amplifier will oscillate good and hard at the frequency represented by this point on the curve.

There are advantages to each method of presenting this information, but we will not go into a discussion of this right here or we will not fulfill the purpose of this article. More detail on the Nyquist diagram appears in *High-Fidelity Circuit Design* (see footnote) if any reader wishes to pursue the subject further. What we want to see is how the loop gain presented in either of these methods is controlled and in what way practical parameters in the amplifier brings about such conditions.

As was explained in the series of articles by George Fletcher Cooper on

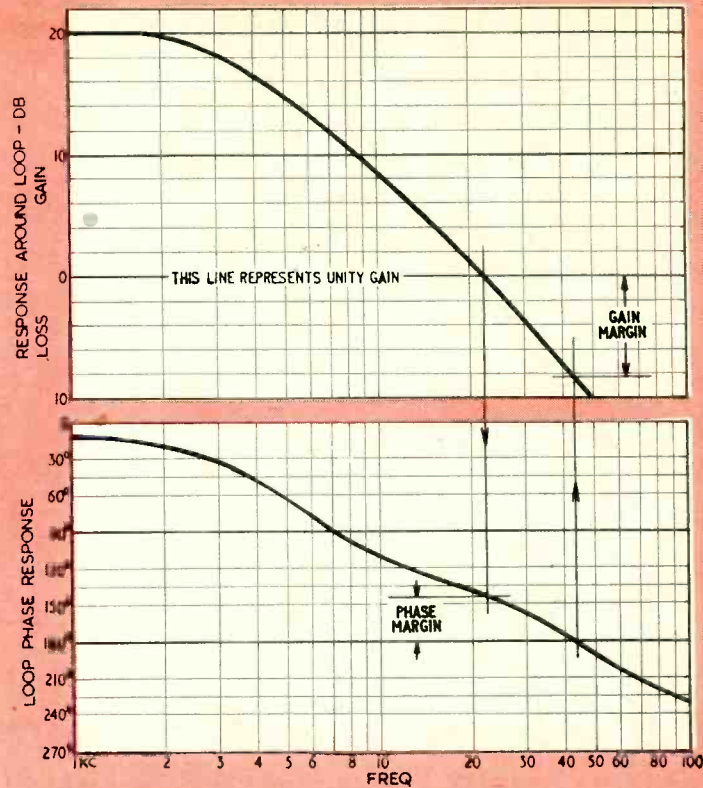

Fig. 4—Typical gain and phase response of an amplifier.

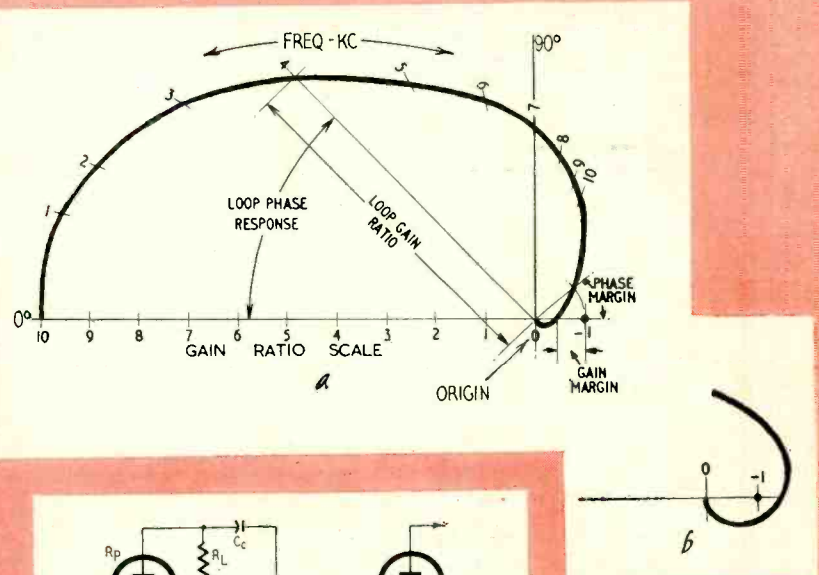

Fig. 5—Nyquist diagrams: a representation of information in Fig. 4; b, curve encircles the critical point, signifying instability. For simplicity, only response above 1 kc is shown.

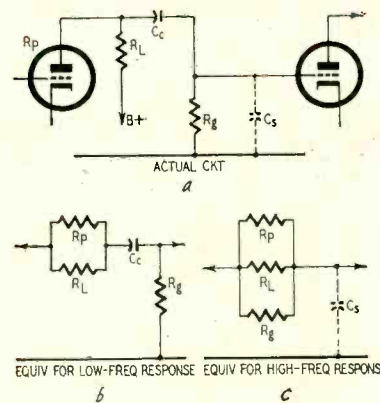

Fig. 6—Typical interstage coupling.

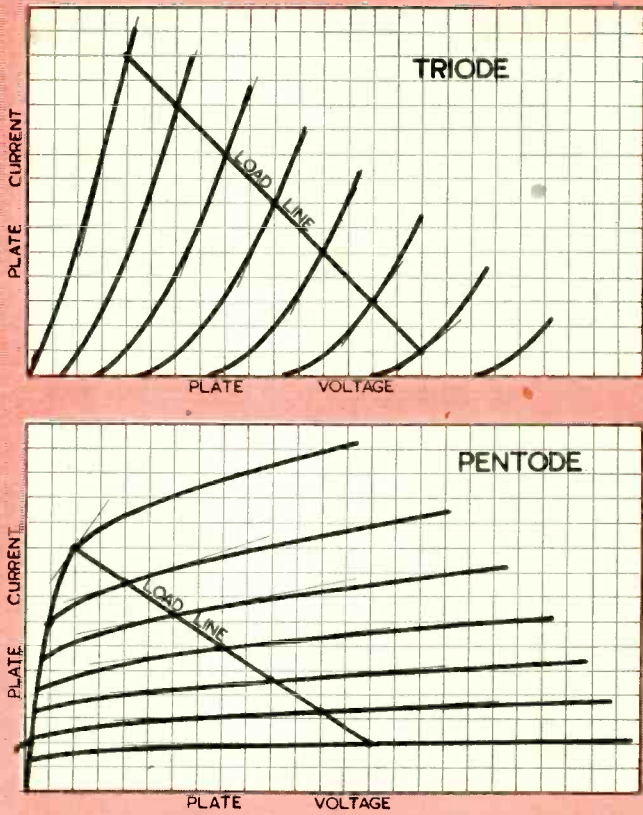

Fig. 7—Plate-current, plate-voltage curves for typical triode and pentode.

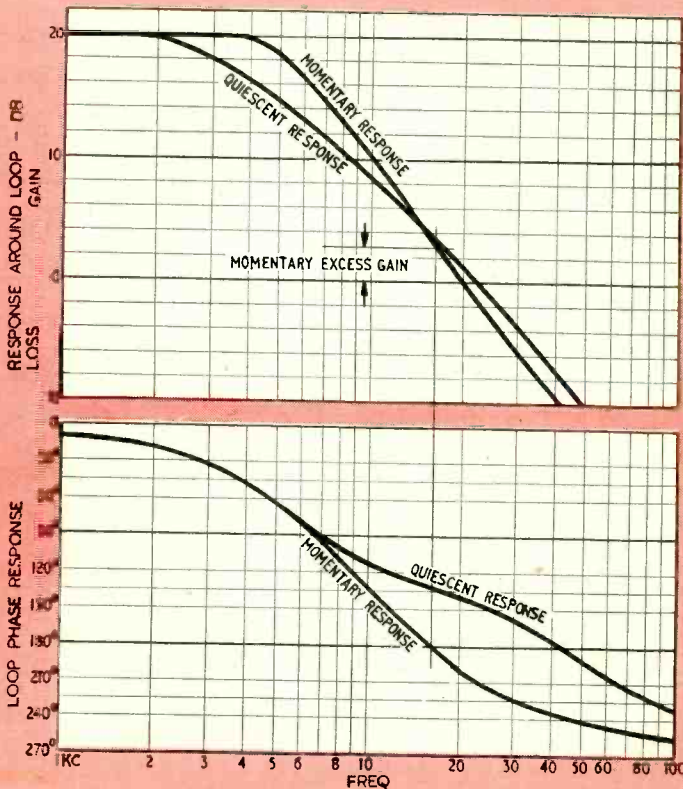

Fig. 8—With small signals response follows quiescent response. With large signals response changes at one point in waveform to position indicated as momentary response.

“Feedback Amplifier Design”*, the roll-off response at each end of the spectrum is contributed to by each of the coupling networks in the amplifier and also by various subsidiary circuitry such as decoupling arrangements. What has not been too clearly explained is how the quantities so contributed can vary with the character of the signal passed through the amplifier in such a manner as to produce some of the kinds of oscillation described.

Take the simple coupling arrangement of Fig. 6-a. Here the relevant quantities are the plate resistance R_p , the plate load resistor R_L , the coupling capacitance C_c and the grid resistor R_g of a following stage. The high-frequency response is controlled by the total stray capacitance C_s .

The low-frequency response is controlled by the relation of the reactance C_c to the total resistance with which it appears to be in series. This consists of R_g on one side and the parallel combination of R_p and R_L on the other side. This is shown at Fig. 6-b.

The high-frequency response is controlled by the relation of the reactance of total stray capacitance C_s to the total circuit resistance with which it appears in parallel. This consists of R_p , R_L and R_g all in parallel (Fig 6-c).

If the amplifier has been designed for minimum distortion, the amplification at all points on a waveform is uniform. Hence the stray capacitance due to Miller effect will be constant so one can regard the reactance component C_s for the high-frequency roll-off as remaining constant under all conditions. The reactance C_c for the low-frequency is naturally constant.

The quantity that varies is R_p . This is illustrated in Fig. 7 for both the pentode and triode. At different points along a load line the value of R_p is represented by the slope at which the characteristics, representing plate current and plate voltage variation for different fixed values of grid voltage, cross the load line. Although the load line has been chosen for minimum distortion in such a way that the intersection points along it representing equal steps in grid voltage are at uniform intervals—which is the condition for minimizing distortion—very often the angle at which the curves cross the load line is not uniform.

This means that the value of R_p in the computation of frequency response will vary at different points on the audio waveform although the overall gain does not vary. Multiply this effect by the number of stages in the amplifier and the result is that the amplitude phase characteristic can vary considerably at different points on the audio waveform. This is illustrated in Fig. 8 and the corresponding effect on the Nyquist diagram is shown in Fig. 9.

Another factor that can vary with different points on the waveform is

* RADIO-ELECTRONICS, Oct., 1950-Nov., 1951. Included in *High-Fidelity Circuit Design*. Gernsback Library, Book 56.

the primary inductance of a transformer since it is not constant as the current through it varies. This particularly applies to an output transformer where the instantaneous values of inductance may change throughout an audio waveform.

From cause to effect

Now how does this explain the different phenomena that we have listed? First the case of the parasitic oscillation shown in Fig. 3.

This is usually caused by the change of plate resistance that occurs in some single-ended part of the amplifier. It will shift the time constants of the high-frequency rolloff at various points in the waveform and the response will go beyond the stability criterion in one direction of the audio signal fluctuation. This causes oscillation at a high frequency to appear at this point on the waveform, the frequency being controlled by the point at which the Nyquist diagram goes beyond the stability criterion. As the waveform causing this variation in transfer response returns toward the quiescent zero of the system, the loop gain characteristic returns to the stable side of the stability criterion and the oscillation dies.

The next case is the amplifier that oscillates when more than a small signal is passed through it.

This can happen in an amplifier that uses tetrodes and pentodes in class-AB push-pull for the output stage. Here the plate resistance, during the quiescent condition, is very much higher than when a signal passes through, causing the plate currents to swing up into the working range of each tube. This means that, not only does the value of R_p change during the waveform, but its *average value* throughout the entire waveform falls. Thus the average response throughout the waveform changes. This may well result in the overall loop gain curve moving over to an average condition where it encircles the critical point at which instability begins. Once this happens the high-frequency oscillation maintains this operating condition within the amplifier and the oscillation continues indefinitely or until the amplifier is switched off.

The other form of oscillation caused in this way is one that has been described before and is ascribed to a condition demonstrated with the Nyquist diagram as being conditional stability. If the attenuation and phase characteristics are such (Fig. 10) that the response goes around the point *without enclosing it*, the amplifier, while operating under this condition, cannot oscillate. But if the gain is reduced by any cause so the amplitude of the whole curve drops, the curve will then enclose the critical point for stability and oscillation starts.

Once oscillation commences there is sufficient gain in this amplifier to set up a saturating oscillation. This produces something like square waves and

the gain during the whole period of the square-wave oscillation averages out so as to keep the Nyquist curve in a position to maintain oscillation.

Viewed otherwise, the gain changes during this square-wave oscillation, being at a maximum during the steep side and falling away at the top because of the saturation condition. This fluctuation of gain throughout the waveform maintains the peculiar form of oscillation that results.

However you explain it, the result is that the amplifier breaks into oscillation as soon as clipping occurs because, during the instant of clipping, the gain of the amplifier momentarily disappears and this is all that is needed to initiate this kind of instability.

The cure

The remedy for all these kinds of instability is much the same as for the continuous kind: Attention to the different circuits of the amplifier to produce a condition where the whole system is *inherently* stable. Any kind of conditional or parasitic oscillation is really a marginal condition that does not quite succeed in being continuously unstable. What is needed is a safer working margin.

The approach to this is to change the circuit values so as to obtain a greater spread in the time constants contributed by all the components that cause the rolloff attenuation and phase shift. This makes the rolloff more gradual so that a greater degree of attenuation can occur before the phase shift becomes as big.

There are a variety of ways to tackle this. But unless we want to get into a complete design problem the simplest way is to just try changing various values and see which ones appear critical and which do not seem to help appreciably. The ones that appear critical are the best bets to proceed with to find a value that gives a good margin of safety.

The high-frequency blocking form of oscillation may not be due to instability around the complete loop. It can often happen just in the output stage or in any single stage of the amplifier, due to a tuned-plate tuned-grid effect. This occurs at some very high frequency, the inductance of the plate lead with the plate capacitance forming one tuned circuit while the inductance of the grid lead with its effective capacitance to ground forms the other.

This is particularly liable to happen with many of the high-efficiency tubes, and the best remedy is a well known one: inserting suitable antiparasitic resistors in the grid and plate circuits. Suitable values are from 5,000 to 50,000 ohms in the grid circuit and from 100 to 500 ohms in the plate circuit. Similar resistors sometimes help in the screen circuit.

The important thing is that the resistors be connected as close as possible to the tube pins themselves—it is the actual lead that forms the in-

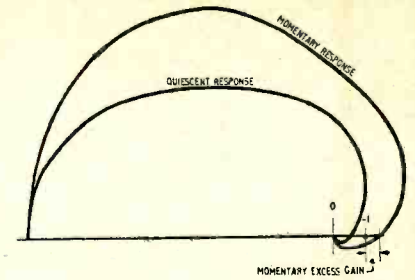

Fig. 9—Information of Fig. 8 converted into Nyquist diagram form.

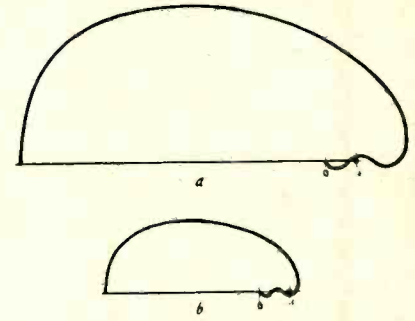

Fig. 10—Nyquist diagram illustrates form of conditional stability: a, amplifier is stable because loop goes inside -1 point; b, reducing gain of amplifier to one-half makes it unstable.

ductance of the tuned circuit and the resistance must be placed between the tube and the inductance that causes the trouble. The capacitance is built into the tube so it cannot be isolated.

Motorboating usually is due to decoupling circuits. The inaudible type of motorboating, however, may be due to a bad choice of coupling components which can cause an almost perfect sine wave at a very low frequency due to the amplifier's becoming unstable. This is not uncommon in feedback amplifiers. The cure for this is changing various coupling capacitor values until a suitable combination is found that gives sufficient spread to get rid of the gain before the phase shift gets too big.

The audible variety of motorboating that goes plop, plop is more often due to bad decoupling arrangements somewhere. The best cure is to try various decoupling capacitor values. If this does not correct the trouble, try a different decoupling arrangement.

Remember that two stages together cannot be unstable by themselves. Instability of this kind occurs due to the fluctuations in the third-stage plate circuit feeding back to the plate circuit of the first stage, or some similar arrangement. This means that, combining the decoupling of the second and third stages of a three-stage amplifier, or maybe operating them both without decoupling and using decoupling just for the first stage, may give the best cure for this kind of instability.

Sometimes the more elaborate the precautions taken to safeguard the situation, the more unexpectedly oscillation turns up. The simplest circuit is usually the best circuit. **END**

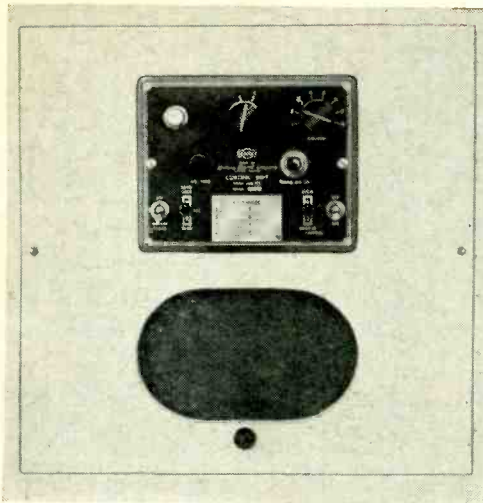

The control unit and the master speaker recessed in the kitchen wall.

Complete Home Intercom System

By JOHN F. MILLAR

MY wife and I first discussed having an intercom in our new home several years ago, when the house was still in the sketch and planning stage. The original idea was to have a simple two-way hookup between a kitchen master station and each of the other rooms, in-

cluding the basement workroom and the children's basement playroom. Further thought suggested that an alternate master station in the living room would be useful during the evening when the children would be upstairs so that they could call Mother or Dad in the living room without

shouting down the stairway. It also seemed logical to include another alternate master on the second floor.

So the plan now called for three master stations and six substations. To keep the cost to a reasonable figure I decided that only one amplifier would be used and the alternate masters would be connected by suitable switching circuits at the kitchen control panel. My wife suggested that the system could also be used to distribute the living room radio program as there would be a speaker located in every room.

The next problem considered was the type of wiring. Fortunately, I came across some shielded cables at surplus prices. A heavy-duty military type, they were available in 14-foot lengths with either two or six conductors. They were ideal for the purpose so a wiring diagram was drawn up and enough cable purchased to install in the walls of the house when it reached the 2-by-4 stage.

Pairs of cables (a two- and a six-conductor) were run vertically from the second floor to the basement and terminated in each room in standard electrical outlet boxes. Provision was made at this time for the amplifier to be located on the upper shelf of one of the kitchen cupboards and the master control panel to be recessed in one of the kitchen walls. Cables were run between these points and also to the basement so that later the whole system could be connected by joining the wires in the basement. The final cable connections are shown in block diagram form in Fig. 1.

Circuit development

After the house was finished the time arrived for the design and construction of the intercom units. A fairly large number of switchings would be needed to change from one function to another and it was of course essential that operation be simple so that the children would find it easy to use. Accordingly, I decided to use relays for the control circuits and arrange things so that only a simple push-to-talk switch could be needed at each substation. The development of the circuits is shown in Figs. 2, 3 and 4.

Fig. 2 indicates the three functions required. Fig. 2-a represents the normal condition (radio distribution) — each station is connected to the amplifier output and the radio program line to the input. Fig. 2-b shows the master speaker only connected to the amplifier output and receiving a call from a substation connected to the input. Fig. 2-c shows the master station calling a selected substation. Wiring to the substations for conditions A and B can be satisfied by one wire common to all substations. Condition C requires a separate wire to each substation. A ground return wire is common to all three conditions and all stations. For relay control, an extra wire (not shown) is needed, common to all stations. Thus each substation requires a total of four

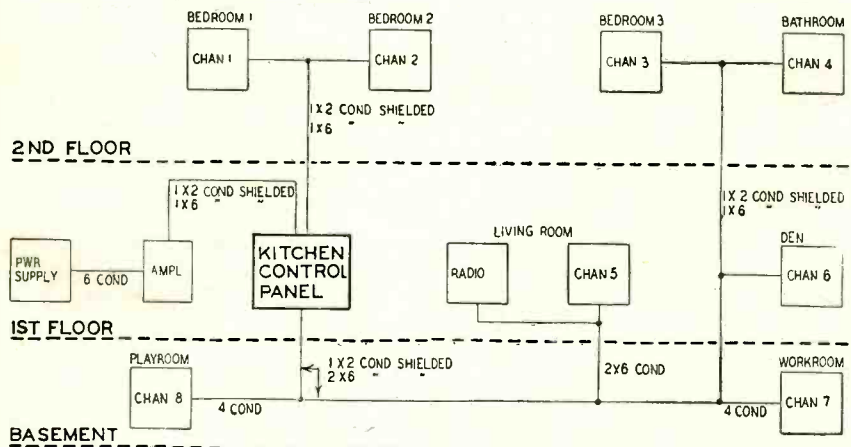

Fig. 1—Basic block diagram shows cable connections between rooms.

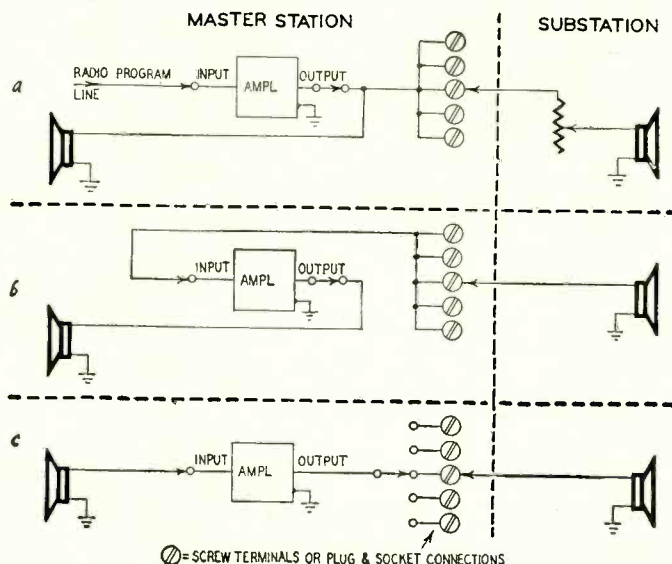
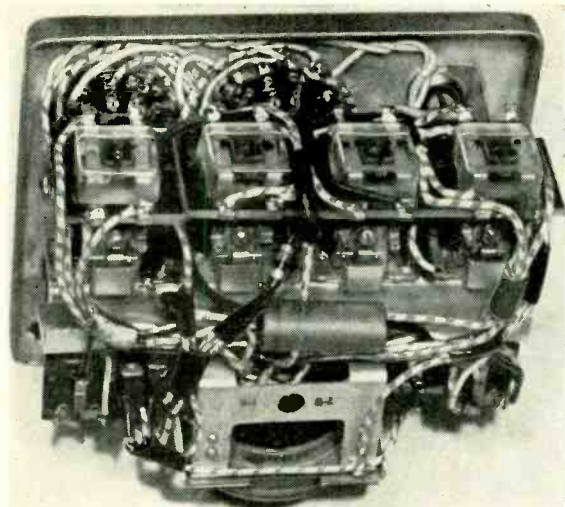
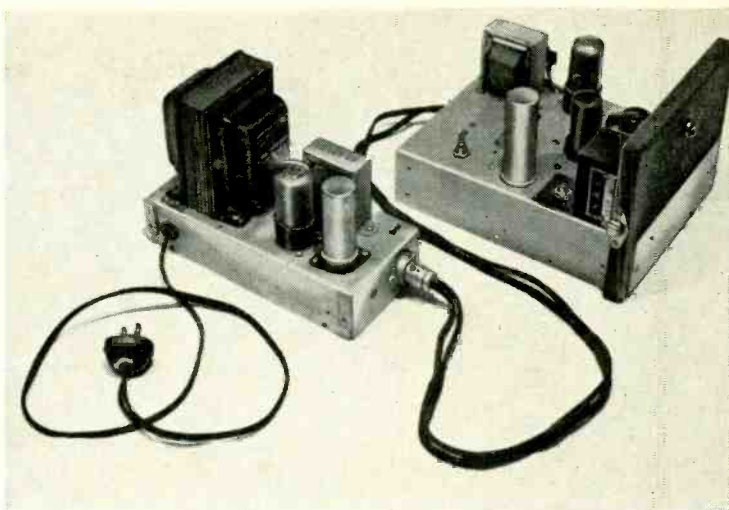

Fig. 2—Operating conditions of system.



Rear view of control unit.



Top view of amplifier and power supply.

wires—one private line for receiving calls and three common lines, namely, a combined *talk* and *radio program*, a relay control and a ground return.

Fig. 3 shows a practical circuit which combines all three sets of conditions of Fig. 2 for a master station and a typical substation. This is the basic circuit of our system. For clarity, separate spdt switches are shown in the diagram. In practice these could be contacts on two multicircuit relays. Switches S1, 2 and 3 change the circuit from *radio to intercom*; switches 4 and 5 reverse the input and output connections of master and substation for intercom use. The operation of this circuit is as follows:

1. With the switches in the positions shown, the input of the amplifier is connected to the radio input line and the output is connected to all stations in parallel so that any station can receive the radio program through an individual volume control.

2. To originate a call from the master to a substation, switch 6 (a spst spring-loaded type) is depressed to the talk position and shorts out both relay coils. This reverses all contacts of switches 1 to 5, changing the circuit from *radio to intercom* and connecting the amplifier input to the master speaker. The output is connected to the substation selected by switch 7.

3. To answer the call or originate a call at the substation, switch 8 is depressed to the TALK position. Its upper section connects the speaker directly to the talk line (bypassing the volume control) while at the same time its lower section shorts out the relay coil controlling switches 1, 2 and 3, reversing their contacts and connecting the talk line to the amplifier input and the master speaker to the output. Switch 8 at the substation is a two-circuit three-position lever switch with the lower position spring-loaded. Note that the substation can receive a call with switch 8 in either the RADIO or LISTEN position.

With this circuit operating controls

are reduced to a minimum. Those at the master station are the push-to-talk switch (S6), the channel selector (S7) and the radio volume control. At the substation only S8 and the volume control are needed.

Final control circuit

In the final version of the system (Fig. 4) the circuit is essentially that of Fig. 3 with the added elements required to control the *remote master* stations. Relay contacts and their associated coils have corresponding numbers. The dpdt relays (RY2, 5 and the upper section of 6) correspond to switches 1 to 5 of Fig. 3. Switch 3 is the master talk-listen switch corresponding to switch 6 of Fig. 3. Switch 3 can short out the coils of both relays 5 and 6 while a substation through the relay control line can short out relay 6 only. The lower section of relay 6 actuates relays 1 and 2 which change the circuit from radio to intercom. Relay 1, actually located on the amplifier chassis, is needed to modify the input circuit of the amplifier when changing from radio to intercom. Switch 4 is the channel selector of the master station.

Operation is the same as that described for Fig. 3—operation of a talk-listen switch at both master and substation for two-way conversation.

The important difference between the

two circuits is that, in Fig. 4, master control can be transferred to either of two remote points (channel 1 or 5) by switches 1 and 2. When switch 1 is changed from the local to the remote position, the circuit is modified as follows:

1. Relay 4 is actuated to transfer the intercom output from the kitchen speaker to that of either channel 1 or 5 via S2-b and the channel selection of S4 to either of the remote selector switches via S2-a.

2. At the same time control of relays 5 and 6 is shifted to the relay control lines of either channel 1 or 5 via switches 1-c, 2-d and 2-e.

3. Switch 3 is shifted to the top of relay 3 via S1-b so that the kitchen master can overrule the remote master setting and still originate calls.

4. If channel 1 has been selected for remote master operation by S2, relay 3 is actuated by S2-c to transfer the radio line of channel 1 to a point separate to that of the other substations to prevent feedback during intercom operations.

Remote master 1 (in the parents' bedroom on the second floor) has only three output channels. These include the kitchen channels 6 and 7 to the basement workroom and the den. There is no need for this master to cover the second-floor rooms. The living room

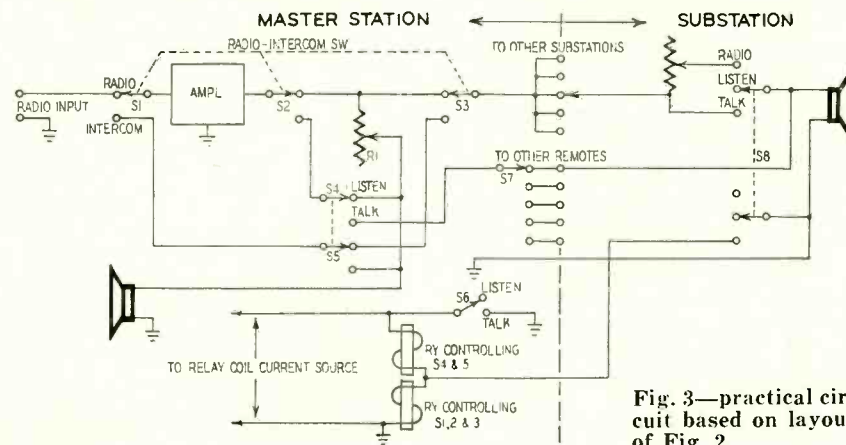

Fig. 3—practical circuit based on layout of Fig. 2.

AUDIO—HIGH FIDELITY

master (channel 5), on the other hand, has six output channels, omitting only the kitchen and the bathroom. This station requires no radio line so only a spst spring-loaded lever switch is needed for intercom operation.

The relays are mostly surplus dpdt units with a coil resistance of 250 ohms. They were originally intended for 24-volt service, requiring a current of 96 ma. However, by slightly reducing the tension of their springs, it was possible to make them pull in sharply with 70 ma. This operating current is obtained by placing the relay coils in series in the negative side of the power supply, essentially as shown in Fig. 5.

The capacitors across the coils (Fig. 4) reduce thumps in the system; the 47-ohm resistors in series with the control switch contacts prevent sparking. The diagram indicates unenergized relay coils by showing the contacts in the upper position. The relays are so arranged that, when 5 and 6 are shorted out, 1 and 2 are inserted in the

circuit so that voltage surges through the power supply are minimized.

Amplifier and power supply

Fig. 6 shows the circuits of the amplifier and power supply. The amplifier consists of a 6SJ7 voltage amplifier feeding a 6J5 driver and a 6V6 output stage. Because the amplifier was to be used for music as well as an intercom, it was necessary to improve the frequency response and reduce distortion. This is done with a corrective filter across the primary of the output transformer and inverse feedback from the voice coil winding back to the cathode of the 6J5. The values shown were determined with the help of a square-wave generator and an oscilloscope to obtain a flat response of the 6J5 and 6V6 stages from 60 to 12,000 cycles, using a single speaker as load.

Additional frequency correction is used at the input for both radio and intercom. Treble boost of the radio input compensates for the loss at the grid of

the 6J5 due to the .001- μ f shunt capacitor. This capacitor prevents oscillation during intercom operation due to stray feedback in the cables. The values of the frequency-correction network at the intercom input were determined from listening tests to obtain the most natural response from the substation "microphones."

The primary of the intercom input transformer is grounded only at the common ground tiepoint at the control unit. This is essential to prevent feedback which will occur if the input and output circuits simultaneously share a

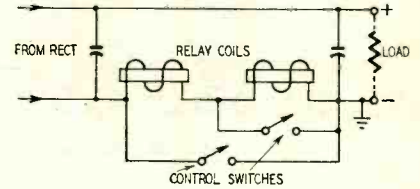

Fig. 5—diagram shows basic circuit for energizing the relay coils.

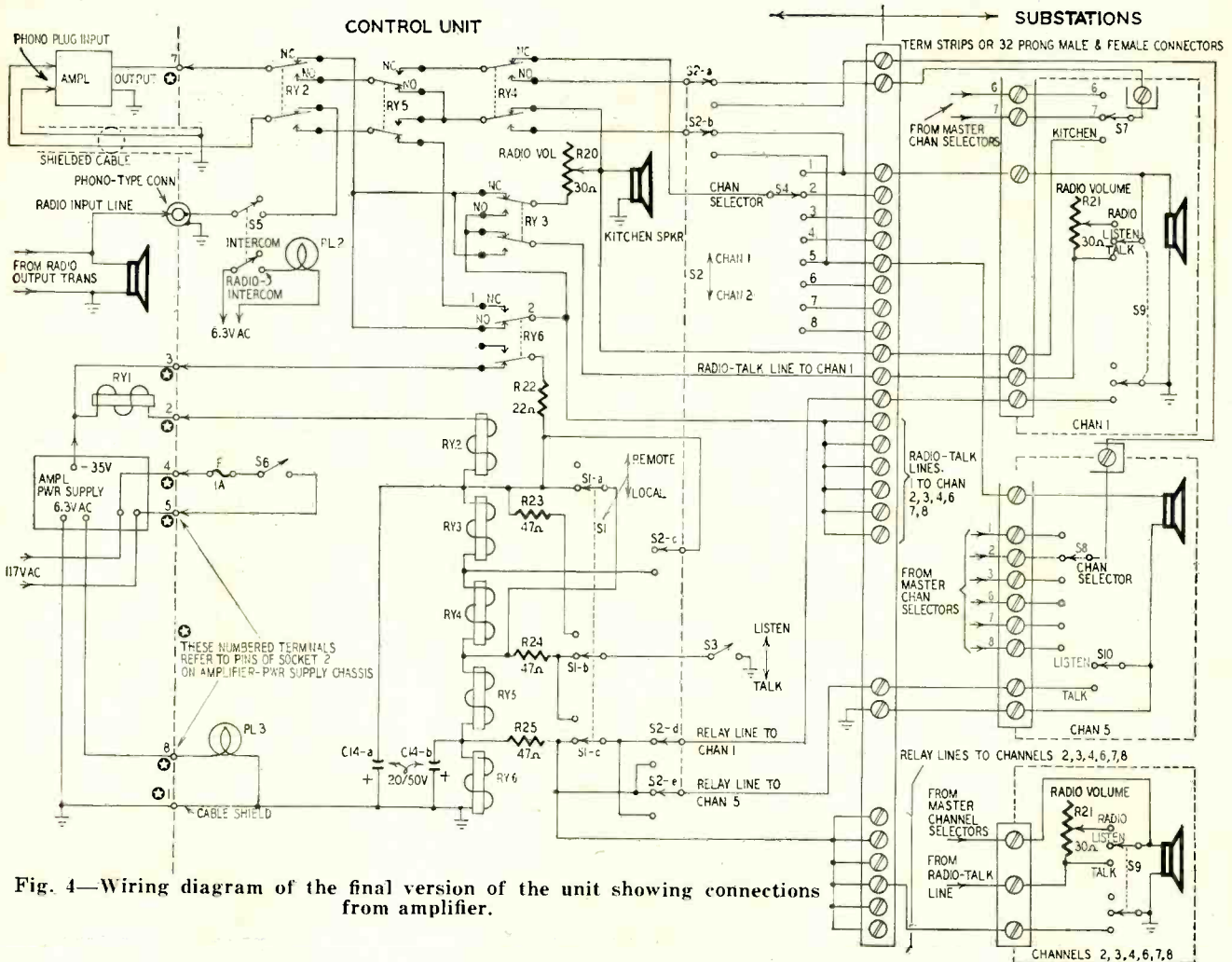

Fig. 4—Wiring diagram of the final version of the unit showing connections from amplifier.

- R20—30 ohms, wirewound rheostat
- R21—30 ohms, wirewound rheostat (7 or as needed for remotes)
- R22—22 ohms
- R23, 24, 25—47 ohms
- All resistors 1/2 watt
- C14—20-20 μ f, 50 volts, electrolytic
- PL2, 3—pilot lamps and assemblies
- F—1-amp fuse and holder

- RY2, 3, 4, 5, 6—surplus dpdt relays, coil resistance 250 ohms (see text)
- S1—3-pole 2-position switch, nonshorting
- S2—5-pole 2-position switch
- S3—spst switch, normally open, spring-loaded
- S4—1-pole 8-position rotary switch
- S5—dpst switch

- S6—spst switch
- S7—1-pole 3-position rotary switch
- S8—1-pole 6-position rotary switch
- S9—2-pole 3-position lever switch, positive indexing in top position; spring return from bottom to center position
- S10—spst momentary or push-button switch

- Chassis for control unit
- 5-inch speakers, as needed
- Outlets for substations, 4-pin miniature sockets (see text)
- Length of 4-conductor cable with 4-pin plug, for substations
- Cabinets for substations

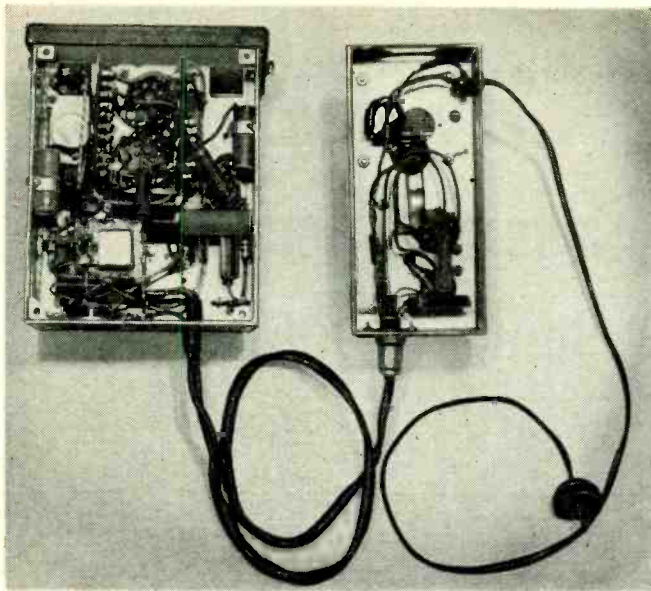

Amplifier and power supply—underchassis.

common wire more than 2 or 3 inches long. This problem was encountered in setting up the remote master circuit for channel 5 and necessitated a separate ground return line for this station as shown in Fig. 4.

The power supply is conventional except for the resistive input to the filter, which helps reduce the peak current demand, prolonging the life of the rectifier tube. This 1,000-ohm resistor is also part of the voltage divider needed to obtain the 250 volts required for the amplifier. The 10-watt 20,000-ohm resistor at the amplifier and the relay coils form the balance of the voltage divider. The combination provides a total current through the relay coils of 70 ma, needed for good snap action of the relays.

Hum problems were minimized by building the power supply and amplifier as separate units. They are placed on the cupboard shelf about 12 inches apart.

A six-wire cable connects the power supply and amplifier and also passes on the connections for the line switch to socket 2 of the amplifier. The connections from the amplifier to the control unit are picked up through an octal plug on the end of a six-conductor shielded cable which enters the kitchen wall at the amplifier shelf. The input connection from the control unit to the amplifier is made through a two-wire shielded cable terminated in a phono plug.

Construction details

The control unit is built into a surplus Bendix control box which contained many of the required parts when purchased. These included lever switches 1 and 3, rotary switches 2 and 4, toggle switches 5 and 6, pilot light 3 and the fuse. The Bendix control box also had a 37-pin Cannon plug for cable connections. I was able to locate the correct matching socket so that the problem of terminating the 32 wires entering the control unit was considerably simplified.

The relays are mounted in line on a piece of aluminum bent to a U shape. Wiring and lead dress are not critical as the audio circuits at this point are all low-impedance. The only circuit problem is arranging the wiring so that the grounded side of the 6.3-volt pilot-light circuits is not common to any part of the audio input circuit, thus avoiding 60-cycle hum.

The shields of the seven cables entering the socket at the control unit are bonded together and connected to three separate pins to minimize contact resistance.

The outlets for the substations in each room are four-pin miniature Amphenol sockets (type 71CPG4) mounted on small aluminum plates attached to the outlet boxes. The plates, painted to match the walls, are inconspicuous. The substation speakers are low-priced 5-inch PM types with 3.2-ohm voice coils. Housed in small walnut cabinets, each has an 8-foot length of four-wire cable terminated in a four-pin Amphenol plug (type 91MPM/4L) to fit the wall-mounted sockets.

The speaker cabinets are enclosed at the back with Masonite panels lined with a sound-absorbing wadded paper (Kimpak). Totally enclosing the cabinets in this way provided a considerable improvement in the low-frequency response.

The speaker in the basement playroom is mounted on a panel recessed flush with the wall for better appearance. The workroom unit is panel-mounted on the workbench.

The radio volume controls at each speaker are small 30-ohm wirewound rheostats and the lever switches are Centralab No. 1477. END

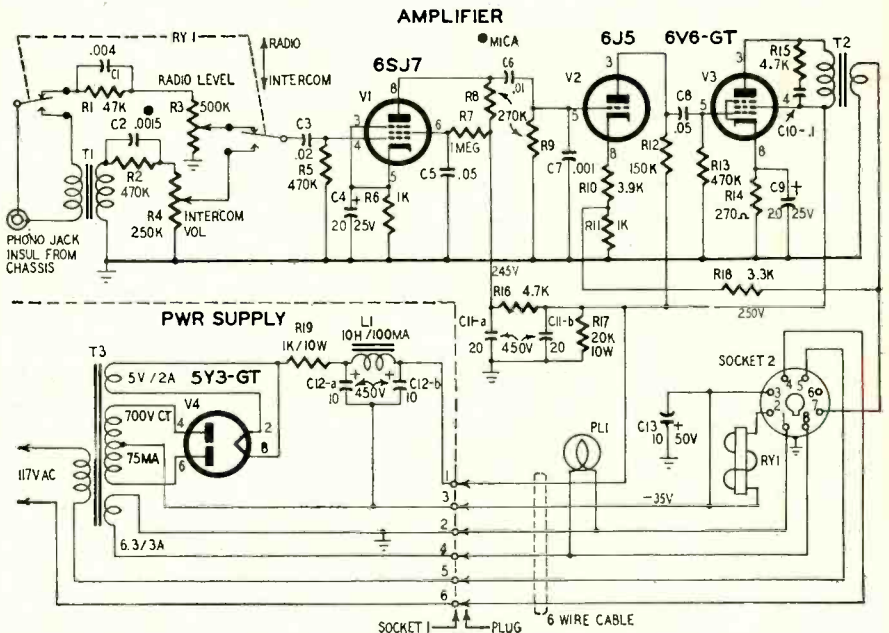
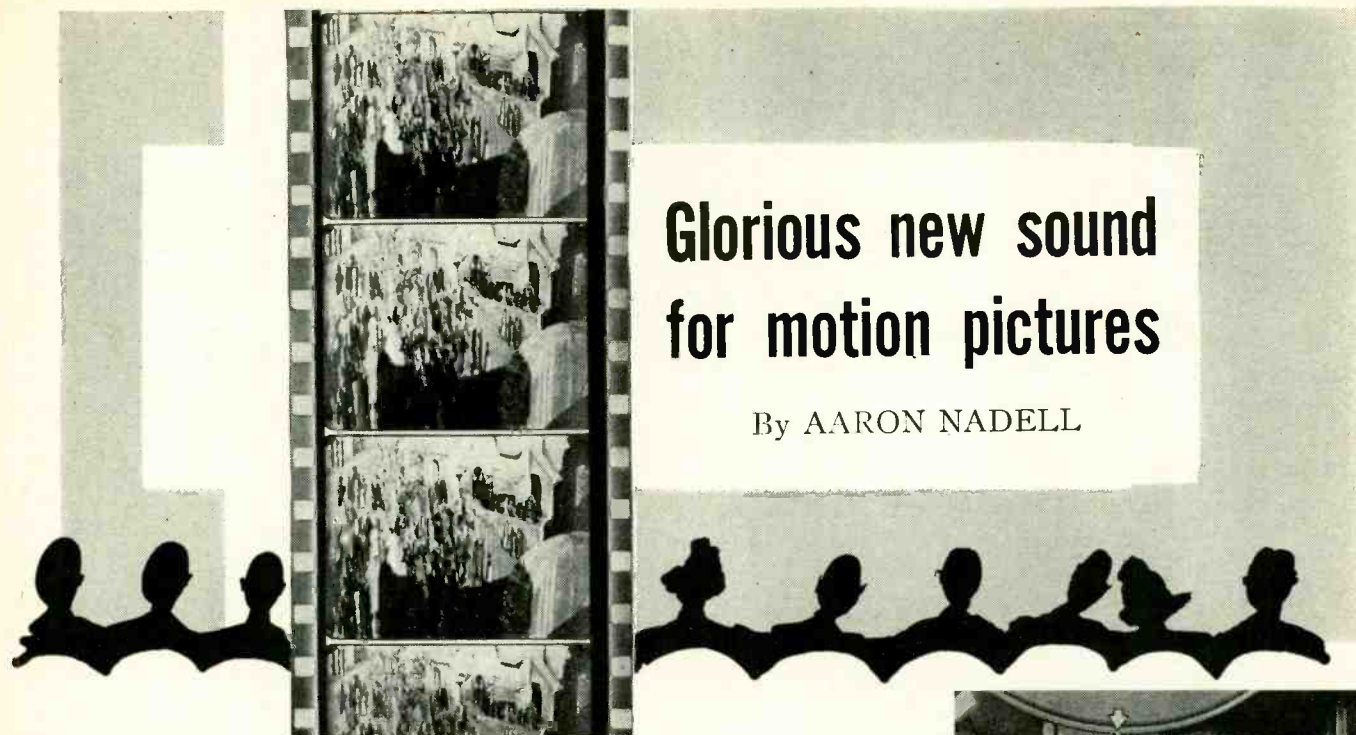

Fig. 6—Schematic diagram of amplifier and power supply, and connections.

- R1—47,000 ohms
- R2—470,000 ohms
- R3—500,000 ohm pot
- R4—250,000-ohm pot
- R5—470,000 ohms
- R6, R11—1,000 ohms
- R7—1 megohm
- R8, R9—270,000 ohms
- R10—3,900 ohms
- R12—150,000 ohms
- R13—470,000 ohms
- R14—270 ohms
- R15—4,700 ohms
- R16—4,700 ohms
- R17—20,000 ohms, 10 watts
- R18—3,300 ohms
- R19—1,000 ohms, 10 watts
- All resistors 1/2 watt unless noted
- C1—.004 µf
- C2—.0015 µf
- C3—.02 µf
- C4—20 µf, 25 volts, electrolytic
- C5, C8—.05 µf
- C6—.01 µf
- C7—.001 µf
- C9—20 µf, 25 volts, electrolytic
- C10—.1 µf
- C11—20-20 µ, 450 volts, electrolytic
- C12—10-10 µf, 450 volts, electrolytic
- C13—10 µf, 50 volts, electrolytic
- All capacitors 600 volts unless noted
- T1—input transformer, voice coil to grid
- T2—output transformer, 5,000-ohm primary to 3.2-ohm secondary
- T3—power transformer, 700 volts ct @ 75 ma, 5 volts @ 2 amps, 6.3 volts @ 3 amps
- L1—choke, 10 henries, 100 ma
- Octal sockets (5).
- RY1—surplus dpdt relay, coil resistance 250 ohms (see text)
- Socket 1, 6 pins
- Plug 1, 6 pins
- V1—6SJ7
- V2—6J5
- V3—6V6-GT
- V4—5Y3-GT
- Socket 2, 8 pins
- Length of 6-conductor cable
- PL1—pilot lamp and assembly
- Chassis for power supply
- Chassis for amplifier
- Line cord and plug
- Phone jack, insulated from chassis



Glorious new sound for motion pictures

By AARON NADELL

Fig. 1—Cinema-Scope film with four magnetically recorded soundtracks.

AUDIO reproduction in the motion-picture theater is no longer the straightforward process it used to be. For the past 3 years theater owners, projectionists and sound service personnel have been going through hectic (and expensive) times. Totally new audio equipment is installed, used for a few months, ripped out before it has begun to pay its cost and replaced by still newer contrivances. Electronic devices not known in any other audio-frequency application have been developed specifically for the motion-picture theater.

The Society of Motion Picture & Television Engineers strives to develop performance standards for a situation that does not remain the same long enough to be standardized in any aspect. Showmen spend money as if it were water, re-equipping theaters that have only just been re-equipped. And the public responds by coming to the box office—sometimes.

The cause of this merry-go-round in the theater is the competition of television. Formerly the little inexpensive neighborhood movie was the place to park the kids or to kill an empty evening. Audio quality was good, but not exactly hi fi. Then came TV to provide pretty much the same technique for keeping kids interested and quiet, and to absorb the spare time of older persons. Several thousand smaller theaters closed their doors. Something had to be done.

The first things done were described in RADIO-ELECTRONICS, March, 1952, in my article "TV Marries the Movies."

The theater industry adopted the ancient and simple principle: "If you can't beat 'em, join 'em." Large-screen TV equipment was developed specifically for the theater. Three systems were evolved. In the simplest, the image on a 7-inch tube, operated at 80 kv, was projected by optical methods to an intensely reflective theater screen. The brightness was inadequate; substitution of the metallized screen for the diffusing screen formerly used in theaters increased brightness in the center seats at a sacrifice of light in the side seats.

For larger theaters the amount of light that could be obtained from a TV tube, even at 80 kv or more, could not begin to compare with the brilliance of a motion-picture arc lamp burning 10 kw. Therefore an indirect method of TV presentation was worked out for larger theaters. The TV receiver was combined with a motion-picture camera and an automatic film developer; a continuous strip of film ran through camera, developer and theater projector. The TV show was photographed as received, automatically developed and projected from film to a theater audience with a time delay measured in seconds.

A third and still more elaborate TV device for theaters was described in RADIO-ELECTRONICS, October, 1952, in an article entitled "The Eidophor Projector." Eidophor, as there explained, is a combination TV receiver, refrigerator, vacuum pump, arc lamp and projection lens system. It utilizes the TV signal to modulate the light of an

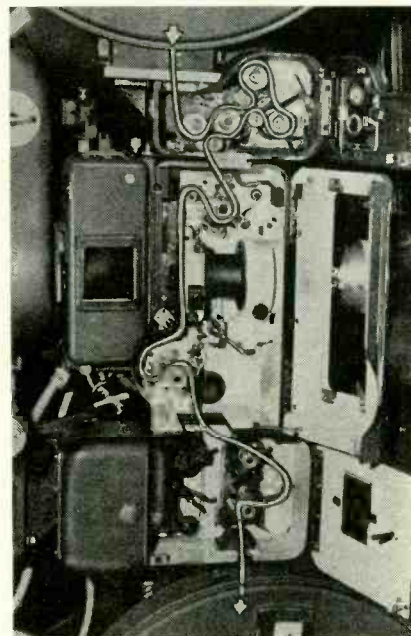

Fig. 2—General Precision "penthouse" four-track magnetic soundhead mounted above International Projector mechanism.

electric arc and thus provide a video image bright enough to fill a large theater screen.

The marriage between TV and the movies failed. Programming was one trouble. Why pay to see it in a theater if you can see it for free at home? The industry's efforts to develop its own programs, which would be available in theaters only, ran into difficulty with transmission costs and FCC regulations. The two methods worked out for large-theater use—the TV-plus-camera method and the Eidophor—were both highly expensive; the former came into limited commercial use for a time; Eidophor to date has not been used commercially.

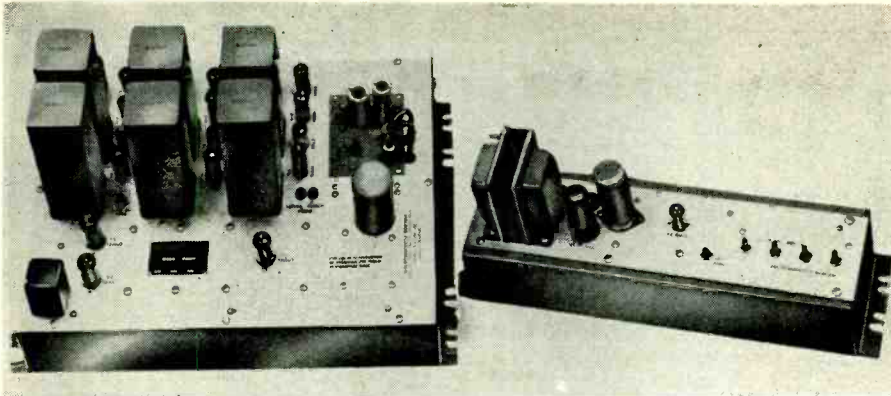

Fig. 3—Fairchild PerspectaSound Integrator handles subaudible frequencies.

Cinerama turned the tide

On Sept. 30, 1952, a new and unheard-of motion picture, with incredibly wonderful audio opened in New York and inaugurated a new era. Cinerama reversed the drooping graph of American theater business and shot it upward. The public stormed to see. People came out at the end of each showing to tell one another with tears in their eyes how wonderful it was! Cinerama's audio is super-hi fi. It is so near to total perfection that Milan's world-famous La Scala opera permitted Cinerama to reproduce the triumphal scene in Aida. The reproduction is such that the Cinerama patron can close his eyes and judging by ears alone almost persuade himself he is really at the opera and not in a movie. The af output at the crescendos must be up in the hundreds of watts—and it is "clean."

The Cinerama system today uses seven microphone channels in recording; seven magnetic soundtracks on a separate, synchronized, 35-mm film; seven theater amplifying channels; five back-screen speakers and two sets of "surround" speakers. Cinerama people claim no audio magic; only the inherent advantages of magnetic recording and amplifiers big enough for their job.

Cinerama as such is not suited to ordinary movie use. It is too vast and overpowering for intimate drama, and it is extremely expensive. For practical purposes it has been followed by CinemaScope ("the poor man's Cinerama"), by three-track stereosound, dimensional sound, Panaphonic sound, PerspectaSound, Warnerphonic sound, etc. The most popular of the new theater sound systems still active are shown in the table.

Multiple-channel audio facilities automatically entail an advantage. Each channel must have enough power to fill the theater while the others are silent. Consequently, when all channels work at once and at full volume the upper limit of the dynamic range is increased several times. In Cinerama and Todd-AO, which use seven and six audio channels, respectively, the total sound power is multiplied by a factor of seven or six. Some forms of CinemaScope utilize four audio soundtracks

RECENT THEATRE SOUND				
Type	Sound-track	Tracks	Rate fpm*	Channels
Standard	Optical	1	90	1
Cinerama	Magnetic	7	146.25	7
CinemaScope 35	Magnetic	4	90	4
CinemaScope 55	Magnetic	4	90	4
CinemaScope 35	Optical	1	90	1
PerspectaSound	Optical	1	180	3†
PerspectaSound	Optical	1	90	3
Superscope	Optical	1	90	1
Todd-AO	Magnetic	6	140.6	6
Cinemiracle	Not yet in use; details not yet available. Similar to Cinerama.			

* feet per minute † film runs laterally

and four amplifying channels, multiplying the upper limit of the dynamic range by a factor of four. PerspectaSound has only one track, but three amplifying channels.

Types of dimensional sound

There are two types of dimensional sound in use. One is truly stereophonic, embodying two or more soundtracks which are not identical but represent the sound as it was heard by two or more microphones placed in different locations. These are amplified and reproduced independently, in separate amplifying channels and through separate sets of loudspeakers. The sounds heard by the patron, not only come from different points of origin behind the screen, but differ in pattern.

The other type of dimensional sound is called directional, to distinguish it from true stereophonic sound. There is only one soundtrack—one recording. But there are either two or three amplifying channels and sets of loudspeakers, and the gain in each channel is varied by some form of control recording—in PerspectaSound, for example, by three subaudible control tones which shift the one-track sound between right, center and left channels. The sounds can be made to originate at different points behind the screen but cannot be differentiated according to spatial origin—that is, it is not possible to make the sound of the violins of the orchestra come from one side of the screen and that of the wind instruments from the other, simultaneously, as can be done with a full stereophonic system. The advantages of directional

over stereophonic sound lie in the economy of using a single-track sound source and therefore are not very great; nevertheless directional sound is strongly favored by some producers.

CinemaScope. The original CinemaScope, and the type used for some years, was on standard motion-picture film 35 mm wide and could be played through standard projectors, provided these were suitably modified. More recently Twentieth Century-Fox has introduced another size film, 55.625 mm wide. This is called CinemaScope 55.

As can be seen in Fig. 1, the CinemaScope film carries four soundtracks. These are magnetic recordings. Three of them play through three amplifying channels and three sets of back-screen speakers. The fourth track and amplifying channel operate side- and rear-wall speakers for special effects. The narrow track is the special-effects recording.

This quadruple CinemaScope soundtrack must be played through a quadruple magnetic reproducer. Fig. 2 shows a "penthouse" soundhead containing such a reproducer installed between the upper (supply) magazine and the projector mechanism. Below the projector mechanism, between it and the lower magazine, is the conventional optical soundhead. The equipment of Fig. 2 can reproduce either conventional single-track optical recordings or CinemaScope quadruple-track magnetic recordings, depending on which type film is threaded in.

PerspectaSound. Paramount's PerspectaSound is a directional but not stereophonic system. It is associated with a special and different picture system called VistaVision.

PerspectaSound, used with VistaVision prints, is recorded as a single conventional optical track. This track can be played through any conventional theater sound system in the usual way. However, the track also carries three subaudible control frequencies. These frequencies, if they are used, are applied to the "integrator unit" shown in Fig. 3. Through this unit the three special frequencies control the gain of each of three audio channels and thereby create directional sound.

Other recent systems

Todd-AO (named for Michael Todd and American Optical Co., its sponsors) represents a successful effort to capture the major attractions of Cinerama while eliminating some of the drawbacks. The screen is deeply curved. There are six magnetic soundtracks, five controlling five sets of speakers located behind the screen and the sixth for the "surround" speakers located on the side and rear walls. There is, however, only a single projector and single arc lamp. Thus the difficulties of keeping a triplex projection system perfectly matched are eliminated. The Todd-AO projection print is double the usual width; that is, 70 instead of 35 mm. Of the six magnetic tracks two

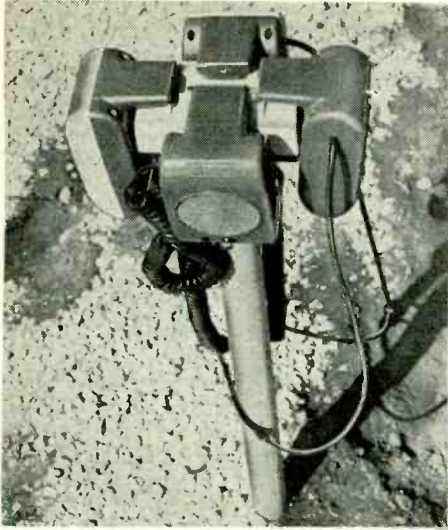

Fig. 4 (top left)—Stereo-sound for automobiles—speakers are distinguished by face colors.

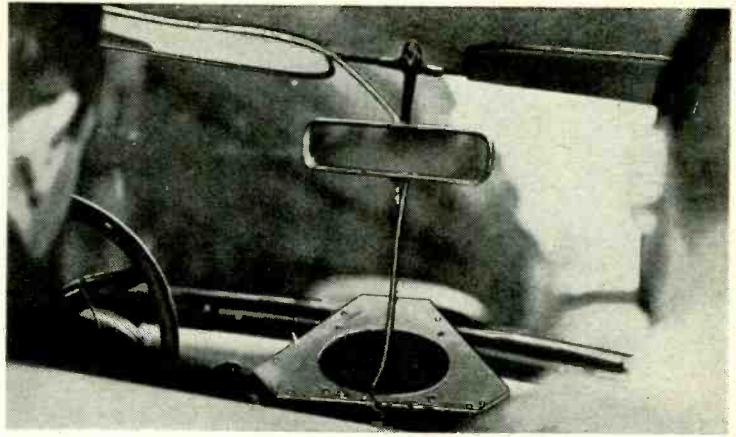

Fig. 5 (above)—Three speakers are in single assembly; use single volume control. Other two are at sides.

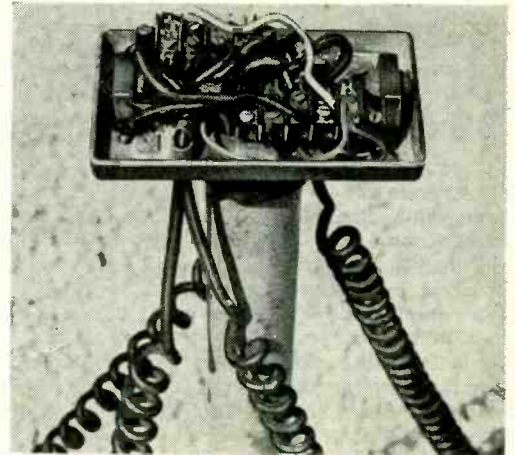

Fig. 6 (right)—Connections for Fig. 4 setup.

are outside each line of sprocket holes, between them and the film edges; one inside each line of sprocket holes, between them and the line of pictures.

Superscope is a system combining essentially the laterally compressed picture of CinemaScope with a single optical soundtrack and thus is very similar to CinemaScope 35 Optical. Superscope sound is conventional.

Warner Brothers some years ago introduced a system of directional sound called Vitasound. It consisted of a single optical soundtrack plus a second or control recording and thus greatly resembled the PerspectaSound which Paramount subsequently developed. But, instead of subaudible frequencies recorded in the optical track, Vitasound used one line of sprocket holes for the location of the control track (the control track occupied the available space between each sprocket hole and the next). The discontinuity introduced into the control recording by the sprocket holes which interrupted it was treated as a low-frequency modulation and filtered off. The higher frequencies of the control recording were then used to vary the volume of sound and to switch sound from speaker to speaker.

Subsequently Warner brought out a full stereophonic system called Warner-Phonic, utilizing four magnetic tracks recorded on a separate 35-mm film. These are reproduced on a rack which is physically isolated from the projector but synchronized with it.

Panaphonic sound achieved directional results with only one amplifier channel but three or four sets of loudspeakers. The amplifier output was switched back and forth among the speakers by relays. The relays were operated by two control tracks, located one in each sprocket hole line, and by two photoelectric cells responsive to the two control tracks.

Stereosound

Among the operational problems of stereosound is the still largely unsolved riddle of how to reconcile multiple sound sources with common auditorium

acoustics. This is a problem unknown to those who concern themselves only with living-room audio problems. A living room, being comparatively small, has a reverberation time of only a small fraction of a second. But in a large theater the normal reverberation time is several seconds and acoustical difficulties proportionately harder to overcome. Even with old-fashioned single-channel sound it may prove troublesome to obtain equal distribution of volume, at all frequencies, throughout the whole seating area. To accomplish this—to punch enough sound into corners or under an overhanging balcony—it is sometimes necessary to orient a speaker so some of its sound will be reflected into the weak area from a convenient wall surface. Another trick, occasionally used when single-channel systems are equipped with multiple back-screen speakers wired in parallel, is to “cross” the speakers so the one on the right supplies sound to the left side of the theater and vice versa—utterly fatal to dimensional illusion!

Stereosound in automobiles?

It might seem that the last theater to install stereosound would be a drive-in. How is the illusion of directionality to be achieved in the constricted interior of the patron's car? And why is it wanted? Yet inventors have devised ways to get stereosound into autos.

Two contrivances to that end are pictured in Figs. 4 and 5. One is the

simple arrangement of putting four speakers instead of two on each speaker post, as in Fig. 4. The patron must be careful to select a right and a left speaker (they are appropriately distinguished), instead of two rights or two lefts, and hang them on his left and right car doors. Fig. 6 shows the speaker post connection box of Fig. 4 opened for servicing.

A second way to put stereosound into the automobile is represented by the equipment item of Fig. 5. This consists of three speakers built into a single unit. The patron takes only one item into his car and places it at approximately the center of the windshield.

The model shown in Fig. 5—Ampex Corporation's—is so built that the two wing speakers face the windshield and their sound is reflected from the windshield to opposite sides of the car interior.

Shape of things to come

At the moment of writing, evolution of new audio procedures for both outdoor and indoor theaters has simmered down, temporarily at least, to a point where it is possible to report what has been happening. For nearly 3 years that was not possible; changes came so fast that a report of them would have been obsolete before it reached print! Only one group of persons, however, can decide whether the present lull will prove brief or permanent—the persons who buy (or don't buy) theater tickets. END

High Fidelity GROWS UP

High-Fidelity Show—AES convention in New York notes steady improvements rather than "revolutionary advances."

By ERIC LESLIE

COMPARED to earlier Audio Shows or Fairs, maturity was the one salient characteristic of the New York High-Fidelity Show held in the Trade Show Building, New York City, at the end of last September. A far cry from the screaming exhibition which only a few years ago was considered a high-fidelity show, this was for the most part a demonstration of equipment constructed for the serious home owner and listener and designed for his living room.

The tendency to package audio in one or two pieces of furniture was marked. But old customs die hard, and the information-room attendant was heard advising one would-be purchaser of a \$1500 TV-tape recorder-player-recorder player-amplifier-enclosure combination that the only way to get true high fidelity was to listen to the separate units and select an ensemble that matched and suited him. More than one music lover, however, appeared to be willing to let the manufacturer's experts do the matching and to trust that what suited them might suit him.

With increasing stress on the everyday aspects of music and sound, the sensational and experimental angles were proportionately de-emphasized. No startling or revolutionary developments were unveiled. Nearest thing was the demonstration by Pickering and Janszen of low-frequency electrostatic speakers (Both had exhibited high-frequency units at last year's show). Weathers of pickup fame also showed a speaker which many at first took to be electrostatic, both from its appearance and sound. However, it used several near-conventional units in a large flat enclosure of unconventional design.

Amplifiers trended toward increased power, those which come first to mind being the Fisher 90-watt laboratory amplifier, the H. H. Scott 80- and 40-watt units and the Dynakit printed-circuit 50-watt amplifier for the do-it-yourself listener.

If components showed no startling advances, demonstration methods did. Accent was on music, not effects. Though levels were occasionally fairly high, there was none of the ear-splitting "brilliance" of earlier shows. Several manufacturers held informal lectures, classes or mass demonstrations to seated audiences. Among the most ambitious of these were Electro-Voice and University, who A-B'ed various setups of equipment and showed the

consumer, not only what he might get for various sums of money, but just how it might sound.

One exhibition room—that of Masco—departed entirely from tradition, with dim lighting, tall candles, candies and nuts on a linen-laid table, a tall fountain and stacked chrysanthemums, with just enough functioning audio equipment to provide incidental music. A modest display of complete home radio-audio-intercom systems, with equipment and floor plans so arranged around the walls as not to obtrude, completed the display.

Maximillian Weil (Audak) again proved that recording has approached the 100% fidelity point, with a concert cellist playing an interrupted duet with her own disc recording. A little strategy was used (she invariably stopped during a crescendo and joined the record again during a low passage) with the result that it was impossible for a person in the fifth row to tell without the aid of his eyes just when the cello started and stopped.

The Audio Engineering Society (AES) convention held in conjunction with the show was not confined by the new conservatism. New theories of stereophonic reproduction were presented by the Ferragraph Co. of Britain and in the paper describing Perspecta-sound. Other papers ranged from recording techniques through pickup design and transistor amplifiers to enclosure theory and magnetic phenomena as applied to speakers. Electro-acoustics and even psycho-acoustics received their share of discussion.

The AES is almost unique among professional societies in that it recognizes the ultimate user of its products. A complete morning session was devoted to consumer testing and stand-

ardization, with papers read by representatives of three organizations to report on products in publications issued for the consumers' benefit. Their reports did not arouse wild enthusiasm among the largely manufacturer-oriented audience, but the fact that they were not only tolerated but invited is highly significant.

While the convention suffered from a certain lack of management (resulting in sudden and baffling program changes) and at times from weak chairmanship, the papers tended to have an originality and impact which contrasted refreshingly with those heard at many similar conventions.

Another lecture session was directed right at the home listener with little or no knowledge of the techniques behind his problem of getting good music in his home. A series of three sessions known as the "Ins and Outs of High Fidelity" consisted of short talks by audio publishers, with long question periods following the short talks. Queries ranged from complex equalization problems to the much more common type like "Do I need an outside antenna for FM?" For the presumably more advanced listener, the information room, staffed by volunteers from the manufacturers' organizations, answered queries.

Some doubt had been expressed about the show administration's policy of charging admission (50c afternoons, 75c evenings) with the idea of eliminating the large crowds of nonserious visitors. But the rooms (much larger than those of former free shows at the New Yorker Hotel) were always comfortably filled, and the attendance almost but not quite justified one exhibitor's saying "If you want a crowd, put on a tax and try to keep 'em out!" END

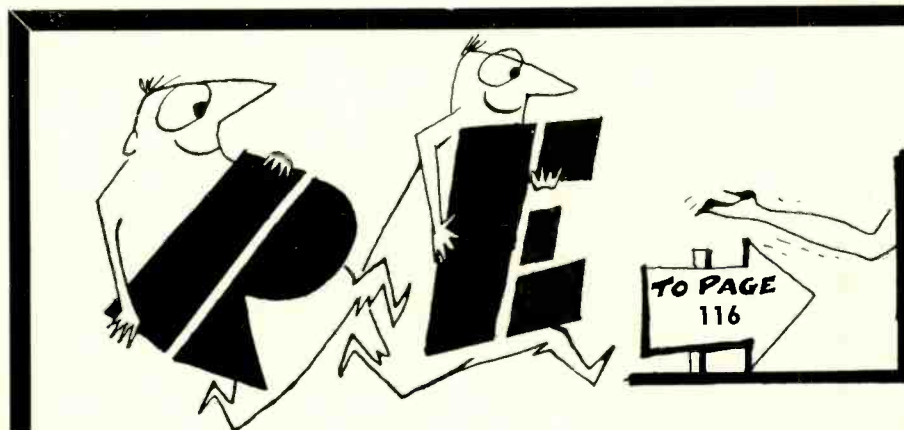



A

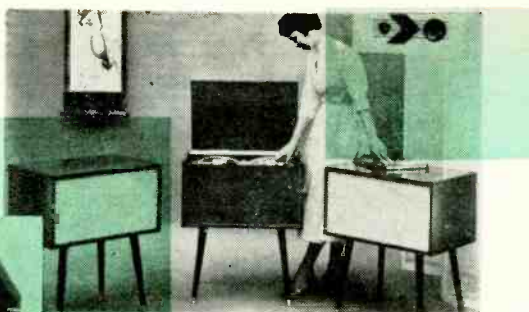

B



C

STEREO TAPE comes of age

By HERMAN BURSTEIN

MOST stereo units are intended for playback only. These include playback preamplifiers and are designed for feeding into dual audio systems (control unit, power amplifier and speaker). All these machines can play monaural tape. However, where an in-line head is used, monaural recordings cannot always be played satisfactorily if both tracks are recorded. Some sound may be picked up from the second track due to cross-talk. The amount of crosstalk varies with the design of the head, and some manufacturers feel that they can use one section of an in-line head to play monaural dual-track recordings.

Stereo tape playback machines now on the market or expected soon include those of Ampex, Concertone, Electronic Teaching Laboratories, EMC, RCA, Telectrosonic, Viking and V-M.

The Ampex stereo "tape phonograph" model 612 uses an in-line head for stereo reproduction and a separate half-track head for conventional dual-track tapes. The 612 is available in either a portable or furniture version at about \$395.* It was previously mentioned that Ampex produces companion amplifier-speaker combinations, the model 620, each costing \$169.50. The complete system, model 612-SS, in furniture, is priced at \$699 in brunette, \$729 in blond. A similar ensemble in portable luggage is priced at \$734.

Berlant-Concertone's stereo tape phonographs are represented by its models 29 and 39 (the latter \$200 higher). Model 29 includes a transport mechanism and two playback preamplifiers at a price of \$549.50. Enclosures cost \$120 additional, so that the total price is \$669.50 (or \$870 for the model 39). As previously stated, Concertone manufactures a combination amplifier-speaker system which contains room for the playback preamplifier. The model 29-7 incorporates the model 29 transport in a wood

*Prices given here are highly approximate and are chiefly to show ratios of cost between one piece of equipment and another. Prices vary too greatly with time, geographical location and dealer audiophile policies to make it possible to come very close to the actual price at any given point some months after the article is written.

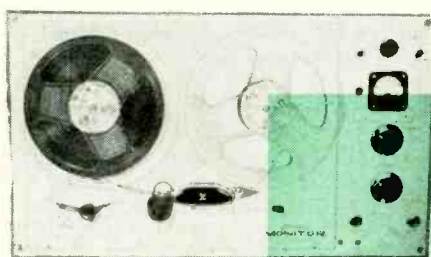

D



E

Part II: Complete playback units; individual components

- A—Ampex 612-SS stereo tape phonograph system (includes 620 amplifier-speakers).
- B—Berlant-Concertone custom 29-7 stereo playback tape-phone combination.
- C—RCA 8STP2 Stereotape player and speaker system.
- D—V-M 750 table model.
- E—V-M's 711 portable stereo playback and monaural recording unit.
- F—Electronic Teaching Laboratories Electro-dual Monitor.
- G—RCA's 8STP1 portable stereotape player-speaker system.
- H—Viking stereo transport.
- I—Newcomb 3D-12 stereo amplifier.
- J—Fenton Co.'s Brenell Mark IVB stereo transport mechanism.

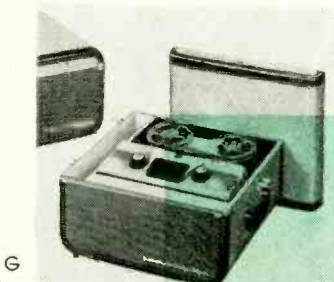

G

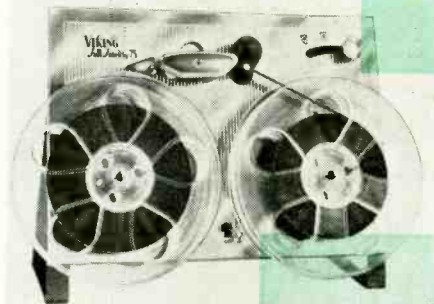

H

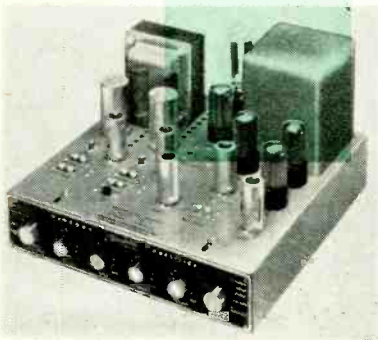

I

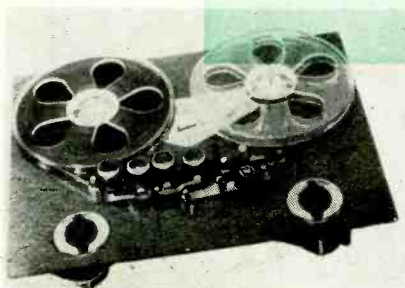

J

cabinet (part No. 105244, priced at \$75) and two units (part Nos. 10521, priced at \$195 each) which contain the power amplifiers and speakers. Total price of this ensemble is \$1,015.

While the Berlant-Concertone machines contain a single in-line head, which is also used for playing conventional dual-track tapes, a half-track head can be added for this purpose if the problem of crosstalk arises. Installing the extra head is easy because the machines have provision for up to five heads. An ensemble such as the model 29-7 can be turned on and off from a single point since the transport mechanism and the left-hand channel can be supplied power from outlets in the right-hand preamplifier, controlled by a switch.

The Electro-Dual Monitor, sold by Electronic Teaching Laboratories, principally intended for teaching purposes, is suitable for home stereo playback as well as monaural recordings. It has staggered heads with standard 1.25-inch spacing and is priced at \$297. The Monitor's transport is a modified Viking, specially manufactured for Electronic Teaching Laboratories. While the standard model of the Monitor operates at 3.75 ips with a frequency response of 40-7,000 cycles, it can also be had in a 7.5-ips model with a response of 40-13,000 cycles.

EMC Recordings Corp. has recently shown its portable model S, designed exclusively for stereo playback. An in-line head is employed. Model S contains a power amplifier rated at 2.5 watts and a speaker, thus requiring an external power amplifier and speaker for stereo playback. The machine's power amplifier and speaker can be bypassed to feed the corresponding channel into external equipment.

RCA's Stereotape Player is available in both a portable model (8STP1) and a cabinet version (8STP2). In addition to the transport mechanism and preamplifiers, it contains a two-channel power amplifier rated at 2.5 watts per channel, all controls and a three-speaker system which constitutes the left-hand channel. Companion units, models SPK2 and SPK3, contain the right-channel speaker system and also provide tape storage space.

RCA utilizes an in-line head. Half of this head used for playing conventional dual-track tapes inasmuch as—according to RCA—the head is of improved design which reduces crosstalk to a low level. Price of the player and speaker ensemble is about \$300 for the portable, \$360 for furniture version.

Scheduled for appearance in early 1957 is Telectrosonic's model 220BMP, which will give the purchaser the option of either in-line or staggered heads. At \$61.50 for staggered heads, this playback unit, which includes preamplifiers but no power amplifiers, may well be the least expensive on the market. The price will probably be higher for an in-line head. Switching from stereo to monaural playback is provided.

One of the most versatile units is the Viking portable tape playback system, which includes the Viking transport mechanism (model FF75SU) and two playback preamplifiers (model PB60) in a portable case (model D390). Price is \$166.50. This "universal" system can play either in-line or staggered stereo tapes as well as monaural dual-track tapes. It includes an in-line as well as a conventional half-track head, spaced the standard 1.25 inches from the in-line head to accommodate staggered tapes.

V-M is currently marketing two units intended not only for stereo playback but also for monaural recording. The 750 is a table model priced at \$259.95, the 711 is a portable priced at \$219.95. Staggered playback heads are used, one of them also being used for recording monaurally. Both models include a single power amplifier and speaker system. For stereo playback it is necessary to feed one of the outputs to an external power amplifier and speaker. Also, if desired, the player's own amplifier or speaker can be bypassed so that both channels can feed into high-fidelity equipment. All V-M monaural tape recorders are designed to accommodate the company's Stere-o-matic conversion kit consisting of a second playback head and preamplifier, priced at \$17.50.

Components

The audiophile who, for reasons of quality, economy or personal taste, prefers to assemble his own system rather than buy a packaged ensemble can also follow his bent with respect to stereo tape. A variety of components such as transport mechanisms, preamplifiers, heads and dual microphone rigs are now available, with more such items soon to appear.

At least two stereo transport units are already on the market. These include heads but no electronic equipment. One is the Fenton Co.'s Brenell Mark IVB which is priced at \$114.50 and employs staggered heads. Altogether, there are four heads: two are for recording as well as playback, the other two are for erase—one of each kind for each channel. The Mark IV, although equipped with only one record-playback head and one erase head for monaural use, has provision for four heads and can easily be converted into a stereo transport by adding two heads at \$9.50 each. The older Mark II has provision for only two heads but can be adapted to stereophonic playback by replacing the erase head with a playback head. (The same can probably be done with other monaural transports, provided that a spacing of 1.25 inches is maintained between gaps of the staggered heads.)

Another stereo transport now available is the Viking (see photo), which comes with a variety of head combinations to suit virtually any requirement. The FF75SU, previously mentioned in connection with Viking's packaged

playback machine, costs \$97.65 and has one in-line and one conventional half-track head, both being suitable for recording as well as playback. Thus the FF75SU permits both stereo and monaural recording and playback, with stereo either on staggered or in-line.

However, there is no erase head, so a bulk eraser must be used instead. A bulk eraser insures a quieter tape than most erase heads so this is not altogether a disadvantage. Viking transport model FF75SR, selling at \$107.50, contains a half-track erase head in addition to one in-line and one half-track record-playback head. This permits erasure for monaural recording. However, spacing problems prevent the in-line and half-track record-playback heads from being 1.25 inches apart, so it is unsuitable for staggered tapes.

Viking models FF75B and FF75B-LP contain two staggered half-track heads, permitting stereo and monaural recording and playback. Bulk erasure must be used. The only difference between the two models is that the latter, which costs \$74.45, includes a pressure pad and a tape lifter that spaces the tape away from the heads during wind and rewind to reduce head wear.

Preamplifiers are available from both Fenton and Viking. Each of these accommodate one channel only, so that two are required for stereo. Fenton's Pro-2, priced at \$79.50, is used for recording and playback, is equipped with a VU meter, claims a signal-to-noise ratio of 60 db and provides three equalization curves for operation at 3.75, 7.5 and 15 ips. The NARTB characteristic is followed at all speeds.

Viking's RP61, priced at \$74.50, serves the same functions, employs an electron-eye tube as a record level indicator, claims a signal-to-noise ratio of 55 db and uses NARTB equalization which can be varied about ± 7 db at 10,000 cycles in playback. For stereo purposes, Viking manufactures a similar model, the RP61S, in which the oscillator is disabled, provision being made to supply bias to both channels from the RP61 preamplifier. As explained before, when using an in-line head it may be necessary to employ a single oscillator to avoid audible beat frequencies due to crosstalk. Viking also makes a preamplifier designed for playback only, the PB60 (\$24.50).

At least two in-line stereo heads are now available. One is the Brush model BK-1072, which can be obtained directly from Brush for about \$25. The other is the Viking 75-S2, which sells for \$33. The latter is made from two conventional Dynamu heads, sliced diagonally and then fitted together for precise alignment of the two gaps. Dynamu manufactures several heads for staggered stereo use. These differ from the conventional half-track models in that they have a wider shield opening on the face of the head. This permits vertical positioning of the heads with respect to the desired channel on the tape. Models 8007 and 8008 are record-

AUDIO—HIGH FIDELITY

playback heads priced at \$27.95 and \$17.60, respectively, while model 8009 is an erase head, priced at \$9.95.

Bell and Newcomb have designed two-channel power amplifiers for stereo use, respectively priced at \$149.95 and \$179.50. These are complete amplifiers—they provide for phono equalization, phono preamplification, tone controls, etc., in addition to power amplification. The Bell 3-DT (see photo) is rated at 10 and the Newcomb 3D-12 at 12 watts per channel.

Both provide many of the same essential functions and features: dual inputs for high-level sources such as tape recorders and radio; dual inputs for magnetic pickups; dual outputs for feeding a tape recorder; overall volume, bass and treble controls, which govern both channels simultaneously; a focus or balance control for changing the relative gain between channels; a selector or function switch for choosing between stereo or monaural output to both channels or for reversing channels (placing the left-hand channel on the right and vice versa); a switch for choosing among various input sources.

The two amplifiers also have individual features of interest. The Bell permits feeding the output of playback heads directly into the amplifier and has loudness compensation that may be switched out. The Newcomb provides a variety of phono equalization characteristics, has a switching facility which permits immediate cutting out either channel 1 or 2, permits correction on one channel for the inside track of Cook stereo disc recordings and includes limit controls for adjusting the gain of each amplifier to avoid overload.

Things to come

The foregoing discussion has dealt only with stereo equipment already on the market or engineered to the point where its characteristics are definite and its appearance imminent. In addition, there is a good deal brewing in the way of stereo items that have reached less advanced stages of development. International Radio & Electronics Corp., which makes Crown tape recorders, plans to introduce a two-channel recorder about Nov. 1. Webster Electric anticipates manufacturing stereo recorders "in the near future." Bell Sound Systems is engineering a kit which can be applied to its RT-75 tape recorder to permit playback of stereo recordings. V-M is planning to put on the market a studio 703 model, intended for both stereo and monaural use and consisting essentially of a transport mechanism to which can be added a variety of preamplifier and power amplifier packages. Fenton and Dynamu are working on the development of in-line heads. EMC contemplates production of a matching power amplifier for the second channel of its model S stereo tape player. And there are others no doubt.

END

STEREO EQUIPMENT PRESENTLY OR SOON TO BE AVAILABLE*

Type of Equipment	Manufacturer	Model or Part No.	Type of Heads	Speakers	Power Amplifiers	Approx. Price	COMMENTS
Record-Playback Units	1 Ampex	S-5290	In-line	0 ^a	0 ^a	\$950	Price for chassis only. \$45 extra for portable case. Unit consists of recorder and 2 620 amplifier-speakers.
		A121 ^f	In-line	0 ^a	0 ^a	\$895	
	2 Berlant-Concertone	23, 33	In-line	0 ^b	0 ^b	\$795, \$995	
	3 Educational Labs.	M-6A, M-7	Staggered	0 ^c	2	\$269, \$295	
	4 Amplifier Corp. of America	Stereo-Magnemite	Staggered	0	0	\$395	Price for chassis only. \$120 extra for 2 portable cases. M-6A provides 1 watt per channel; M-7, nearly 5. Price for 7.5-ips model. Portable with spring-wound motor.
Playback Units	5 Ampex	612	In-line	0 ^a	0 ^a	\$395	Auxiliary half-track head for monaural tapes. Price for chassis only. \$120 extra for 2 portable cases. Permits monaural recording. Amplifier and/or speaker can be bypassed to feed hi-fi equipment. 2.5 watts per channel. Speaker is 3-unit system for left channel. In-line head optional at probably higher price. Plays in-line, staggered and monaural tapes. Amplifier and/or speaker can be bypassed to feed hi-fi equipment.
	6 Berlant-Concertone	29, 39	In-line	0 ^b	0 ^b	\$550, \$750	
	7 Electronic Teaching Labs.	Electro-Dual Monitor S	Staggered	0	0	\$297	
	8 EMC Recordings Corp.		In-line	1	1	No information	
	9 RCA	8STP1, 8STP2	In-line	1 ^d	2	\$250, \$285	
	10 Telectrosonic	220-BMP	Staggered	0	0	\$62	
	11 Viking	Portable Playback System 750; 711	In-line & Staggered	0	0	\$167	
	12 V-M		Staggered	1	1	\$260, \$220	
Companion Amplifiers and/or Speakers	13 Ampex	620	1	1	\$170	Amplifier-speaker combination. Portable or cabinet. Amplifier-speaker combinations, respectively, as portable or cabinet. Room for one preamplifier. Two speakers in split case.
	14 Berlant-Concertone	105250, 105251	1	1	\$150, \$195	
	15 Educational Labs.	EL-2S	2	0	\$48	
	16 RCA	SPK-2 ^e , SPK-3 ^e	1	0	\$50, \$75	
Transports	17 Fenton Co.	Brenell Mark IVB	Staggered	\$115	Contains 2 record-play heads and 2 erase heads. Contains 2 record-play heads: 1 in-line and 1 half-track; no erase heads. Same transport available with other head combinations.
	18 Viking	FF75SU, other	In-line & Staggered	\$98, other	
Preamplifiers	19 Fenton Co.	Pre-2	\$80	Record-play, single channel. Record-play, single channel, RP61S for second channel. Play only, single channel.
	20 Viking	RP61	\$75	
	21 Viking	PB60	\$25	
Heads	22 Brush	BK-1072	In-line	\$25	Record-play. Record-play. 8007, 8008 are record-play heads; 8009 an erase head.
	23 Viking	75-S2	In-line	\$33	
	24 Dynamu	8007, 8008; 8009	Staggered	\$28, \$18; \$10	
Dual Amplifiers	25 Bell	3-DT	2	\$150	10 watts per channel. Tone controls, phono equalization, etc. 12 watts per channel. Tone controls, phono equalization, etc.
	26 Newcomb	3D-12	2	\$180	
Stereo Conversion	27 Berlant-Concertone	Various	In-line	0	0	Various	Converts monaural Berlant-Concertone units to stereo. Additional record-play and erase heads to convert monaural Brenell transports for stereo. Converts V-M recorders for staggered stereo playback.
	28 Fenton Co.	Heads	Staggered	\$10	
	29 V-M	Stere-o-matic	Staggered	0	0	\$18	

^a See line 13.

^b See line 14.

^c See line 15.

^d See line 16.

^e Matching unit for RCA playback.

^f Companion model, the A122, is same as A121 except it is housed in portable cases.

*As of Oct. 1, 1956, approximately. Due to the rapid increase in stereophonic equipment, there should be a number of additions to and modifications in this material before this is printed. List is based on information supplied; since some manufacturers did not supply requested information, list may not be complete.

Model A423 contains the A121 units plus an AM-FM tuner, a 3-speed record changer and a control unit, all in one cabinet at \$1,470. A323 is same as A423, without radio tuner and phonograph.

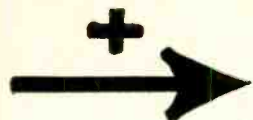

DRY CELLS CAN BE



By RALPH W. HALLOWS



THAT it is possible to reactivate dry (Leclanché) cells was proven as long ago as 1938. In a paper read that year before the American Electrochemical Society, Kenneth A. Cobb and Robert P. Graham (Department of Chemical Engineering of the University of Washington) showed that No. 6 cells, discharged for short periods at 250 ma, could be kept in good condition almost indefinitely by applying a suitable direct current with a reverse voltage immediately after discharge.

Their experiments were, unfortunately, not very realistic. Using rotary switches they discharged banks of cells at 250 ma for a few seconds and then immediately recharged them with a reverse dc of the same amount for two or three times as long. In this way they obtained many hundreds of ampere-hours (vastly more than the electrochemical equivalent of the zinc in their cans) from No. 6 cells. But no one who uses a dry cell for any ordinary purpose is going to treat it that way. Reactivation cannot be of real value unless it can be applied after a fairly long period of intermittent or continuous discharge.

In a long series of experiments made over the years I found that reactivation by applying reverse dc gave reasonably good, though not startling, results under the following conditions:

1. The cell must be in good condition and not "stale" as the result of long shelf life.
2. It must not be run down to an underload voltage much below 1.
3. Recharging must start very soon after the cell is taken off load.
4. The reverse dc must be tapered down to about 1.7 volts. If this is not done, the open-circuit voltage of a cell may rise to as much as 2.5. The cell may become very hot and actually burst, with horribly messy results.

Even under these conditions the times that any dry cell can be reactivated is very limited. With a high-grade cell 10-15 successful reactivations are possible. But after that the story is always the same: the can

punctures and the cell becomes useless.

Things are very different if the reactivating current consists, not of pure dc, but of dc with a certain amount of superimposed ac. A year or two ago a Dutch electrical engineer, Mynheer Beer, produced a reactivating apparatus called the Elektrophoor. Various forms of it are widely used in Holland for reactivating all kinds of dry cells and batteries. The circuit of an Elektrophoor for recharging three 30 x 55-mm cells in series is shown in Fig. 1. The metal rectifier is shunted by a series resistor of 250 ohms. The resulting charging "dc" (Fig. 2) consists of a short-duration positive peak, followed by a shallow negative trough.

The discharge of a dry cell is in two parts: the main chemical reaction is the conversion of zinc as attacked by ammonium chloride into zinc chloride, ammonia and hydrogen. This results in the formation of a mass of neutral hydrogen bubbles around the positive carbon electrode. These clog the cell, raise its internal resistance and decrease its voltage. To counteract this the cell contains a depolarizer of magnesium dioxide. The net result is that the unwanted hydrogen combines with the manganese dioxide to form manganese oxide and water.

But as the cell discharges, the depolarizing process is never quite good enough. Neutral hydrogen bubbles are concentrated around the positive electrode rather faster than the depolarizer can dissipate them. The cell becomes choked by this accumulation of hydrogen and its emf falls off. Even if the cell is rested for a time after discharge, the depolarizing process is never quite complete. There is always some rise in internal resistance and some fall in emf.

Since the discharge of a dry cell is a twofold process, reactivation can be successful only if it also is twofold. It must not only reconstitute the depolarizer but also restore the electrolyte to its original form and redeposit the zinc on the inside of the can. Reverse dc depolarizes a rundown cell *if* (and

these are big "ifs") the cell is discharged at a fairly heavy rate and if the reactivating current is applied almost immediately afterward. It also to a large extent reconstitutes the electrolyte. But it does *not* redeposit the zinc as a smooth, evenly distributed coating on the can. This is the big snag. Break open a cell which has been reactivated in this way and you will find that the zinc returned from the electrolyte consists mainly of small, spongy lumps distributed in patches over the inner surface of the can. The inevitable result is that after a few discharges and reactivations thin places develop and the can punctures.

Matters are very different when a small amount of ac is superimposed on the reverse dc. The redeposition of the zinc is closely akin to electroplating, and electroplating experts have found that suitable amounts of superimposed ac work wonders. I don't pretend to be able to explain what takes place, but I imagine that the ac provides some kind of electrochemical shakeup which is absent when dc alone is applied.

The results, anyhow, are far-reaching for the zinc is redeposited smoothly and evenly. With this method reactivation is successful not just with cells which have been heavily discharged for a short period, nor need the mixture of dc and ac be applied immediately after discharge. I have, for example, flashlight cells still in use after more than 18 months of regular service. They are reactivated only when the light becomes dim, and this may be at intervals of 7 to 30 or more days, according to the time of year.

Cells discharged slowly under light loads can also be successfully reactivated, provided their voltage does not fall much below 1. The dry cell can, in fact, be made to behave very much as if it were a secondary cell, the main limiting factor to its useful life being the eventual drying out of the electrolyte.

An interesting new field for experiment is opened now that transistor apparatus is reviving the demand for dry cells. It is more than likely that the value of the resistor in Fig. 1 is not ideal. Still better results might be obtained by increasing the duration of the positive half-cycle of Fig. 2 and reducing that of the negative, or vice versa. It's certainly well worth investigating!

END

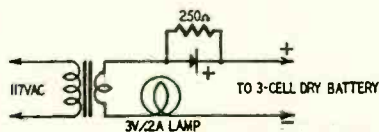

Fig. 1—Schematic of a successful Dutch dry-cell reactivator, the Elektrophoor.

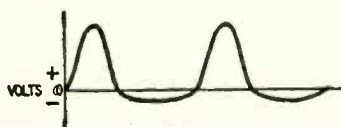
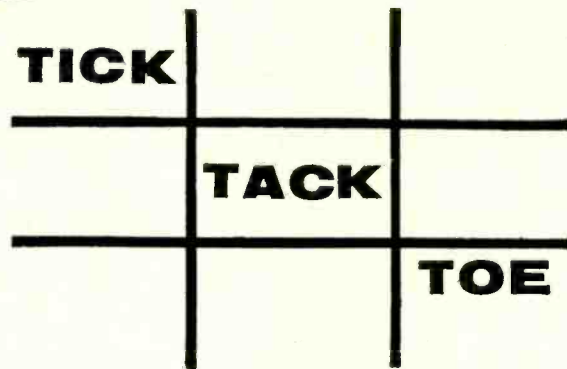

Fig. 2—Waveform of the reactivating voltage applied to the dry cell.

relay moe plays



By EDMUND C. BERKELEY*

ON the front cover of this issue of RADIO-ELECTRONICS appears a picture of an automatic relay machine which can play tick-tack-toe—or tit-tat-toe, as many prefer to call it—with a human opponent. This machine—which we call Relay Moe—is one of the more recent of twenty-odd small robots we have made in the last six years as a part of a scientific program of exploring the behavior of intelligent machines, with the help of part-time college students studying electronics or electrical engineering. (Two of them—"Simon," a miniature automatic digital computer made of relays, and "Squee," an electronic robot "squirrel"—appeared on the front covers of RADIO-ELECTRONICS in October, 1950, and December, 1951, respectively.)

Playing with Relay Moe

You can play tick-tack-toe with Relay Moe, if you want to, in our laboratory in New York City. (But please write us beforehand to request a date.)

If you wish the machine to play first, press the MACHINE-MOVE-FIRST button (see Fig. 1). Then the machine will choose a square and light a red light in it.

If you wish to play first, press the green button under the square that you choose. Then the square right above your button lights with a green light. The machine then starts its program of thinking, turning a plastic cylindrical drum (the timing drum) with associated cams which control the successive timing of the circuits; decides on its move and turns on a red light in some other square.

Then you can make another move. And so on.

If the machine wins, a red light is turned on in the top row of the board, red again indicating the machine. If the game is a draw, a white light is turned on in the second row at the top of the board. If you win the game against the machine, a green light is turned on in the third row, green again indicating the human player.

If you are disgusted with the way the game is going (or has gone) and want

to start a new one, press the NEXT-GAME button at the bottom of the board, which cancels whatever is on the board and leaves the equipment ready to start a new game.

General layout

The general layout of the machine is shown in Fig. 1. It has been made in two sections, the display board and the main chassis (or "brain"). At the top of each one is a long handle, so that it can be moved around. The two sections are connected by two multi-wire cables and two large Jones plugs. The main chassis contains at its bottom a transformer and rectifier which convert 117-volt ac into 24-volt dc to operate some 90 relays, a motor, a stepper and other apparatus inside the main chassis.

Two groups, each including 9 of the 90 relays, correspond with the 9 squares of the board. One group records the machine's moves into any particular square of the board: the MM or Machine-Move relays. Another group of 9 relays corresponds with the human player moving into any particular square of the board: the PM or Player-Move relays. In parallel with the coil of each of these relays is a small red or green light, respectively. So, as each square on the display board lights up red or green, light of the same color goes on in the main chassis.

This is a rather striking parallel to results reported by a brain surgeon operating on a rabbit. As various parts of a rabbit's retina were stimulated with light, so various parts of its brain showed electrical excitation, reported in neon tubes, and the pattern of vision was roughly repeated in the neons.

The machine's strategy

Several different kinds of strategy are built into Relay Moe. One is *variable intelligence*. In the back of the main chassis are three horizontal cams, called the Machine Intelligence Cams, affecting three snap-action switches. These cams are plastic discs mounted eccentrically so that from time to time they close their switches and disable certain circuits to give the machine less

than perfect intelligence. On such occasions the human player may win.

Some more details are shown in Fig. 2. As the cams revolve, four conditions—known as cases A, B, C or D—may prevail. In case A, which is the condition 52% of the time, the machine plays to win at all times; the human player can only lose or draw. In case B, 16% of the time the player can win every game. In case C the human player has a chance to win every time and in case D he may win under certain situations. Cases C and D each occupy 16% of the playing time.

Also in the main chassis are a set of Board Rotation relays. To make the machine strategy harder for a human player to guess, after every game the machine in its "computing mind" turns the board a random multiple of 90°. Of course, the board does not actually turn, but the machine thinks of it as turned. This prevents a human being from guessing quickly what is the machine's strategy or what sequence of moves it plays, because after each game the machine plays a randomly rotated strategy.

Thus the strategy of the machine is hard to guess and is different from game to game, and sometimes the human player has a chance of winning (see Fig. 2). This makes Relay Moe more fun to play a game with than if it were unvarying and always perfect.

Intelligence control does not affect the offensive and defensive machine moves. Thus the machine when playing defensively will always block a human player having only one set of two squares in a row by occupying an empty third square in the same row, and when playing offensively will always occupy an empty third square in a row if it already has taken two squares in that row. Diminution of intelligence only affects the machine when it has a choice of making a move not involving a decisive offensive or defensive play, *except* that in cases B and C, the machine will never choose to take the center square.

A full rotation of the intelligence control cams takes place once for every 60 games if the Board Rotating relays are switched to act.

*Berkeley Enterprises, Newtonville, Mass., and New York, N.Y.

Fig. 1—A closeup of Relay Moe's main components.

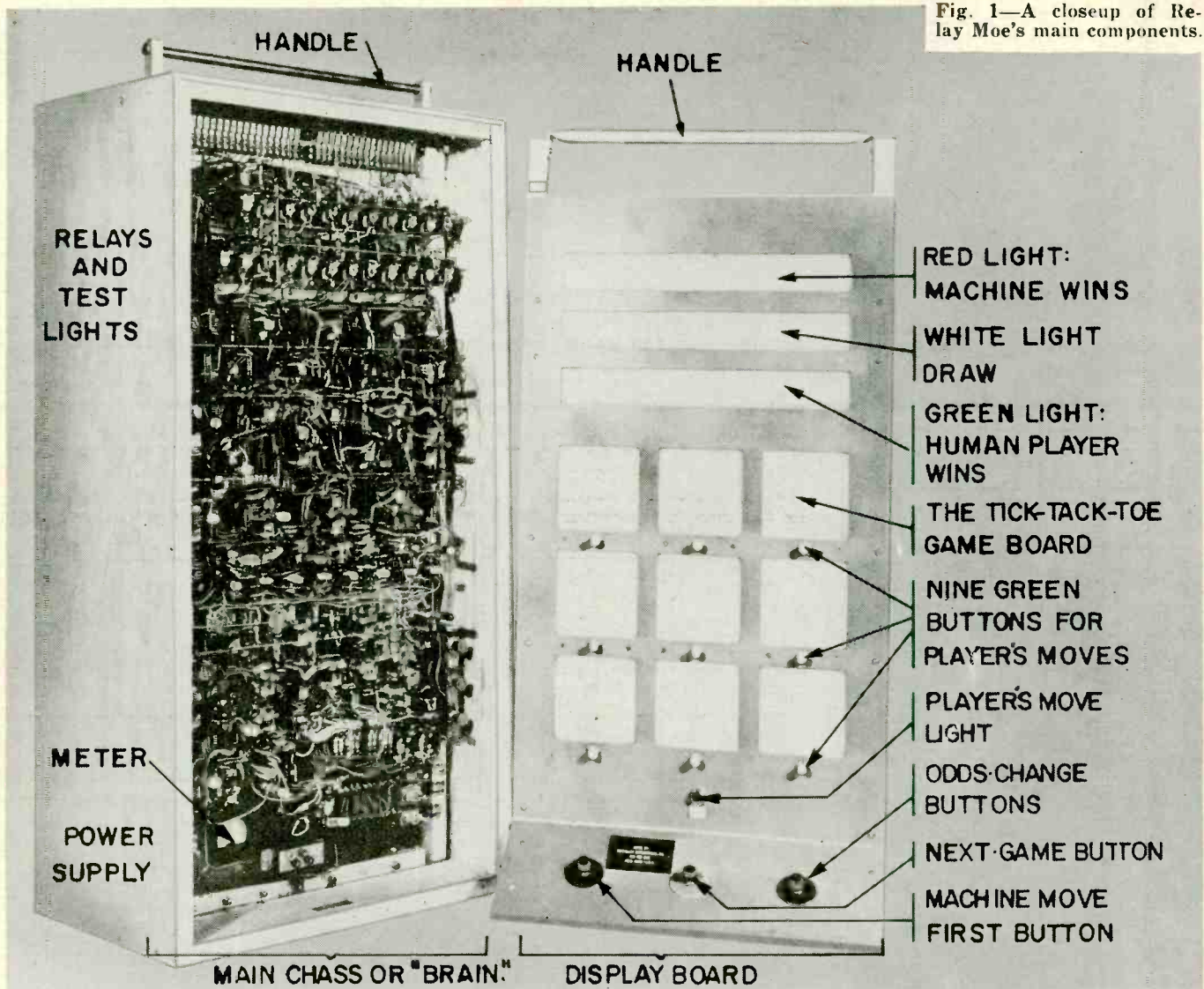

The basic organization of the behavior of the machine is controlled by a Timing Drum, a large plastic cylinder with protuberances here and there which act as cams and close snap-action switches so that in a full cycle of the machine about 13 timed sources of current are used. These are identified as times A, B, C, D, E, (two each), and X, Y and Z (one each). Making use of these times, various circuits carry out their functions during every single machine cycle (see Fig. 3). The timing

drum and the motor which turns it are located in the middle of the back of the main chassis (not visible in Fig. 1).

For example, the first thing that may happen is that a player may push a button under a square. This will happen at Resting Point time. If a moderately low resistance path from the button to ground exists and if the square selected is unoccupied, a sensi-

tive relay is energized. This energizes another relay which then disconnects the sensitive relay and allows further steps in the operation of the machine to continue. After the player's move, the machine first searches for an offensive (winning) move, using the first set of times A, B, C, D, E of Fig. 3. Failing to win, the machine checks for a defensive (blocking) move, using the

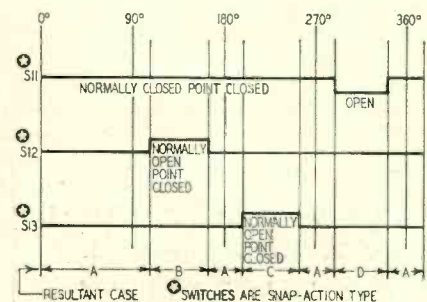

Fig. 2—The intelligence circuits. Rotation of the cams assures the machine's winning half the time; gives the player a chance the other half.

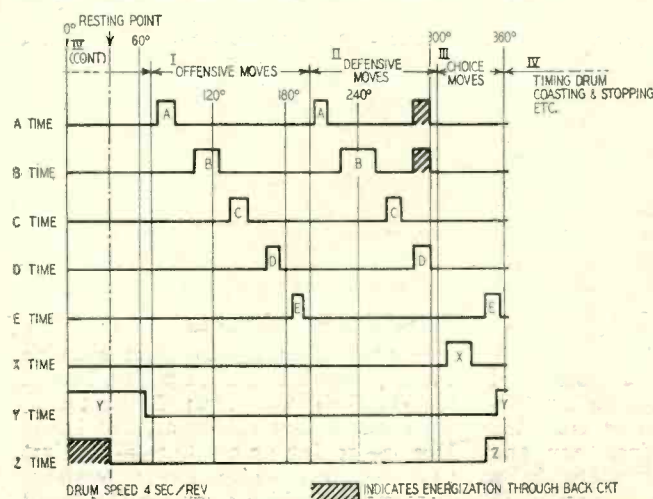

Fig. 3—Timing circuits set sequence of operations. These are controlled by switches on a drum.

ELECTRONICS

second set of times A, B, C, D, E. If none can be made, a decision is made at X time and the machine plays the best move it can make.

Let us continue with the same example. The player having moved and the drum having reached A time, the machine considers effective moves. The first thing it does is to look at the squares which it has already occupied to see if there is any winning unoccupied square (the third square in a row, not occupied by the human player). For example, consider the position:

THE SITUATION			KEY TO BOARD		
O		O	1	2	3
O	X		4	5	6
X		X	7	8	9

In this position the machine (X) has played three times and the human player (O) has also played three times. The machine considers the situation, observing that its possible winning squares are 1, 3 and 8 as shown by the figures on the board at right. (The situation is examined by the Computing Circuit, which we will explain later.)

At A time, the machine considers and then stores in the Intermediate Memory (IM) relays all the winning squares (in this case, 1, 3 and 8). At B time the machine considers occupancy, cancelling out of the IM relays the squares already occupied (1, 3) so that only square 8 remains. At C time the machine selects a line (called the Machine Choice line), corresponding to an uncancelled IM relay, in a succession of choices in numerical sequence. Since there is only one square (8) not cancelled, the machine chooses that square and actuates Machine-Move (MM) relay 8. At D time, the machine checks to see if it has picked up any MM relay at C time. If so, it decides that it has won. Then the rest of the cycle is cancelled and the machine turns on the "Machine Won" light.

If the machine has no winning move, it uses the rest of the cycle defensively, putting the human player's position into the Computing Circuit (see below). The same strategy as above is followed, with the machine putting X's in what would otherwise be winning squares for the human player and making choices in the event of no defensive or offensive answer. These functions make use of the second A, B, C and D times and the E, X, Y and Z times.

Computing circuit

Perhaps the most interesting part of the machine is the Computing Circuit. It receives information from the MM relays and determines, for any two occupied squares together in a line, what third square is needed to

make three in a row. If, as indicated above, there is no such move, the E pulse clears the computing circuit. The circuit then receives information during the second A time from the Player-Move (PM) relays and determines for any two player-occupied squares what third square is needed to make three in a row.

How does the circuit operate? Fig. 4 shows:

a The numbers of the squares of the board;

b The eight possible rows of three;

c The third or winning square determined by the other two squares.

This is the situation which this circuit of the machine must handle. The circuit which performs this work is shown in Fig. 5. Here the B (branching-network) relays (B1 to B9), for which only contacts are shown, have received the information contained in the MM or PM relays, whichever are being ex-

rotation) what strategy it follows. Contrary to the very brief report about Relay Moe given in *Life* magazine (March 19, 1956), the machine can be beaten by a human being, and the percentage of the time he does so on the average can be varied widely by

THE EIGHT ROWS OF THREE	WINNING SQUARE	DETERMINED BY
1 2 3	1	2,3,5,9;4,7
1 5 9	2	1,3;5,8
4 7	3	1,2;5,7,6,9
2 5 8	4	1,7;5,6
3 5 7	6	3,9;4,5
3 6 9	7	1,4,3,5;8,9
4 5 6	8	2,5;7,9
7 8 9	9	1,5;3,6;7,8

Fig. 4—Information the machine uses in selecting winning moves or blocking the player.

changing the cam settings.

Relay Moe however has a wider significance, as one of our series of small robots (computing, reasoning, puzzle-solving, game-playing machines, etc)

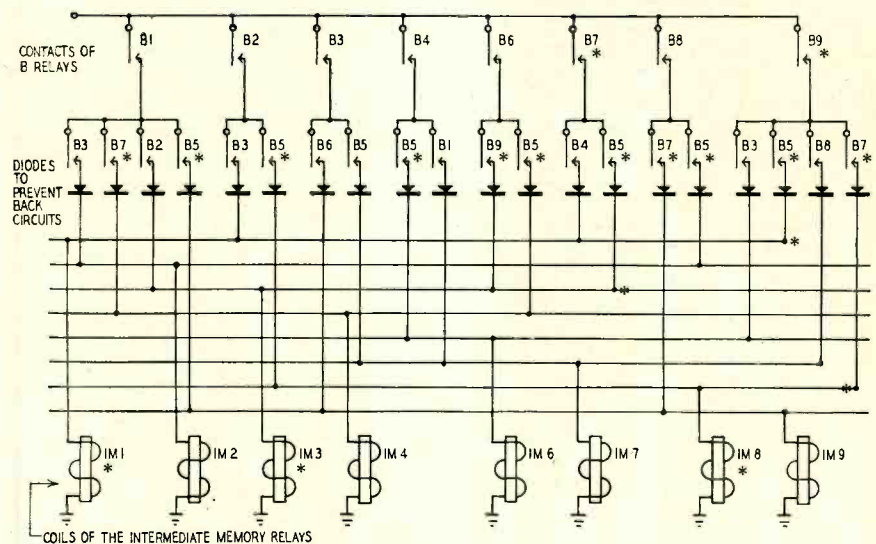

Fig. 5—The computing circuits which actually select the moves.

amined. IM relays record the possible winning squares to be played in (or to be blocked) if possible.

Now let us look at Fig. 5 again. How is the position computed by the computing circuit? The machine (X) has played in squares 5, 7 and 9. Therefore this information energizes the B5, B7 and B9 relays and their contacts close. These contacts are marked with an asterisk in Fig. 5. If we trace through the circuit, we can see that the lines marked with the asterisk are "hot." Accordingly, the appropriate IM relays are energized. These are the IM1, IM3 and IM8 relays. Now at B time, as explained above, the IM1 and IM3 relays are cancelled because occupied and IM8 remains energized.

Relay Moe's significance

Relay Moe is not the first machine which plays tick-tack-toe with a human player; Bell Telephone Laboratories, for example, has made one. But Relay Moe is—so far as we know—the first such machine which has a variable strategy and which disguises (by board

of different types and capacities. We plan to make (and are making) many kinds of small machines and robots that display intelligent behavior. They range from the Geniac and Tyniac (two "tiny genius") electric brain construction kits (finished) up to a simple automatic electronic digital computer using transistors called Simplic (not finished).

We think that a good part of the job of learning about the important new development of machines that handle information automatically and reasonably may be accomplished by constructing and operating just such working models as these. END

In the JANUARY TV ANNUAL
of RADIO-ELECTRONICS

How the Apple Tube Works
Black-and-White Adjustments
in Color TV

ELECTRONICS

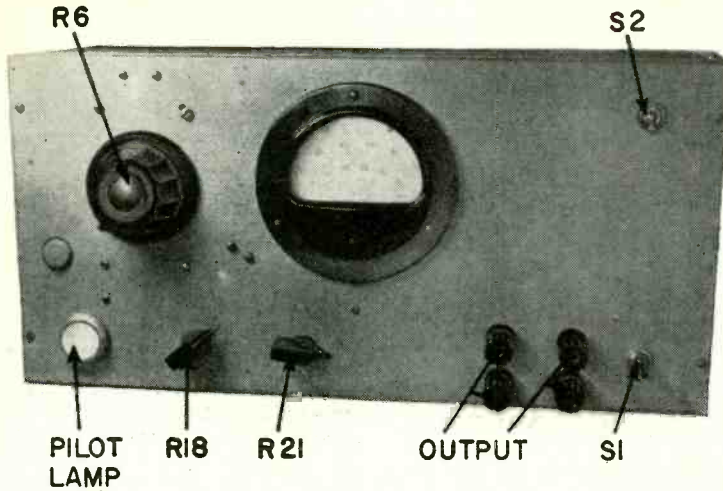

Front view of Electronic stimulator.

Top view shows placement of parts.

erator is shown on Fig. 2. Five tubes are used. V1 is the 3,000-cycle sine-wave oscillator, V2 the output power amplifier, V3 the gating multivibrator, V4 the gating-relay control and V5 the full-wave power supply rectifier for the generator.

Looking for the simplest to build and to calibrate, the cathode-coupled negative-resistance oscillator was chosen. It is rather easy to select audio choke L from the junkbox and to tune it by trial and error to 3,000 cps, using a suitable value for C1. It is not necessary to tune very exactly; any frequency from 2,500 to 3,500 cycles will do. The amplitude of oscillation may be adjusted by varying the common cathode resistor R2, a 10,000-ohm 2-watt unit.

Power amplifier V2 works into an output transformer with a 5,000-ohm primary and 500-ohm secondary. The amplitude control (R6) and gating circuit (relay contacts in series with one electrode) are on the secondary side of the transformer to prevent switching transients.

Gating multivibrator V3 operates at less than 1 cycle per second when the slider of the GATING FREQUENCY control is at the ground end. Moving it toward B plus raises the frequency to several cycles per second. The square-wave output of V3 controls thyatron V4 operated with ac on its plate. The plate circuit of V4 consists of the 10,000-ohm 10-ma relay coil shunted by C10 in series with R20 and R21. R21, the ANTI-CHATTER control, is adjusted for quiet relay operation. R18 controls the firing point of V4 and thus the mark-space ratio.

Relay RY has dpdt contacts, one working contact closing the generator output circuit and the other lighting simultaneously a pilot lamp, thus showing the working cycle of the stimulus. A rectifier type output meter is for checking amplitude of output voltage. As the meter is connected before the gating contact, it is easy to compare the no-load and full-load voltages and see how much the body impedance lowers the output.

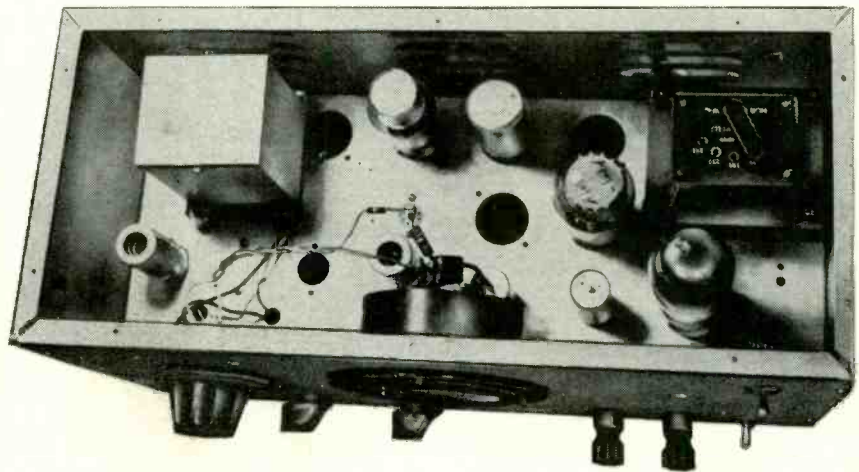

Underchassis view. Note Continental type construction of some parts.

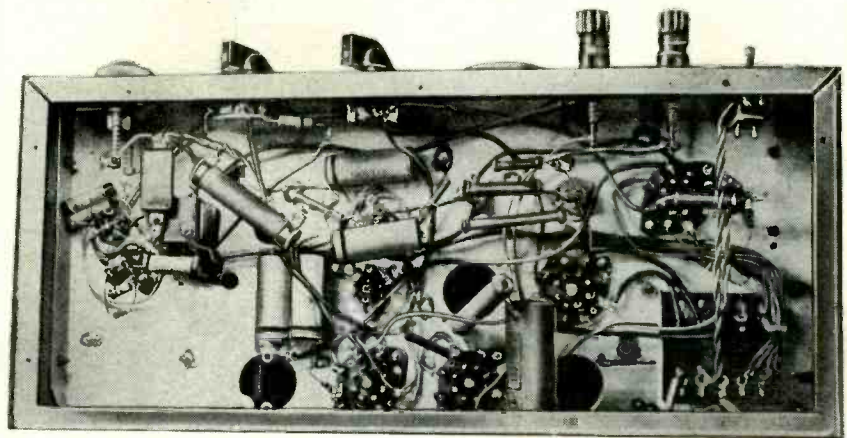

Operating the generator

Electronic technicians know a lot about making metallic contacts but little about electrodes on living tissues, consisting chiefly of water and ionized salts. The electrodes generally used are thin metal sheets of about 4 x 5 inches made of a soft corrosion-resistant metal such as tin or very pure aluminum. These electrodes are never to contact the skin directly; a synthetic sponge of the household-

cleaning type has to be placed between the electrode and the skin. This sponge has to be moistened to conduct. In some cases when generator voltage is ample with regard to the required stimulus, ordinary tap water will do; if the series impedance thus introduced lowers too much the current available, the sponges are to be wetted amply with salted water made by dissolving ordinary kitchen salt in warm tap water up to saturation. Fig. 3 shows

how rubber bands are used to fix the sponge-electrode sandwich on the member to be treated.

Make sure that S1 and S2 (gas tube switch) are open (OFF) and connect the chassis to a good earth ground or a cold-water pipe. Set the OUTPUT control

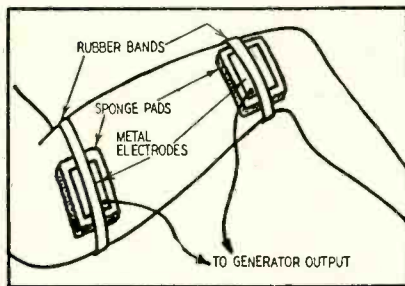

Fig. 3—Construction of the electrodes.

(R6) to MIN. Plug in the generator and attach the pads to the affected member. Close S1 and wait 20 seconds or so for the 2050 to warm up. Close S2. (Applying plate voltage to the thyatron before its heater reaches normal operating temperature shortens its life.)

You will hear the relay begin operating and the pilot lamp will flash. Now adjust R18 so the lamp is on and off for approximately equal periods and set the gating control for a fairly slow rate. Gradually turn up the output control and you will begin to feel electrical shocks. You can then adjust the control for ample stimulating current without pain or discomfort. Touch up the settings of R10 and R18 as desired. The working of the muscular system is very spectacular. The instantaneous swelling and relaxing of the muscles is seen clearly.

A word of caution

To get gear working in a jiffy, a technician may junk parts together without care for safety. *This is not an experimental device, but a therapy unit, and a definite health hazard may result from neglecting elementary safety rules.* A good practice is to connect the ground of the generator to a reliable ground line. The 500-ohm transformer secondary thus being grounded, no dangerous voltage can build up should there be a leakage in one of the transformers. Don't attempt building ac-dc jobs to save a transformer! You may lose your life!

In keeping with the nature of this unit, all wiring should be done with great care. In addition to a reliable ground line, all connections should be double checked. While the ac line is the principal source of danger, also watch all B-circuit wiring in this electronic device.

It has to be emphasized too that the muscular trainer, while being very important for muscular reeducation, *will not cure arthritis*; you always need assistance of a physician for that. A good plan is to talk it over with him. He may advise you on the particular muscles to make work. **END**

SONAR in ONE HOUR

Simple experimental setup demonstrates radar and sonar theories.

By JAMES H. BOYDEN

HERE'S an interesting and educational device that can be set up in an hour or less to demonstrate the principles of radar and sonar in a very simple, straightforward manner. The diagram shows the setup. It requires little special equipment except for the high-frequency driver units, which many hi-fi fans have in their speaker systems.

The 20-cycle output of a square-wave generator (I used a Heathkit electronic switch) is differentiated by a 1,000-ohm resistor and .001- μ f capacitor, giving sharp recurrent pulses. These pulses are fed into a reasonably hi-fi amplifier of moderate power output, connected to a high-frequency driver unit. This driver squirts out pulses of audio with a large percentage of high-frequency components. This is the sonar "transmitter."

The receiver consists of another driver unit used as a microphone, with an output transformer T connected backward to step up the voltage, fed into a high-gain phono preamp. A standard intercom input transformer

The picture will be more stable if the pulse voltage from one of the stages of the power amplifier is fed into the external sync circuit of the scope. The gain of the receiver can be increased many times by using a parabolic reflector. Though not too many people have these lying around, a good substitute can be made from ordinary posterboard bent into a rough parabolic shape.

Using two drivers from a University 4402 dual tweeter and a small amplifier (12AX7 amplifier-phase inverter and push-pull 6AQ5's), I was able to get return pips from a wall 30 feet away that were actually larger than the initial pips. In this case, range (distance) was limited by pulse frequency and room dimensions. Small objects such as a book or a person's hand could be "seen" easily if they were oriented properly. Experimenting with separation of transmitter and receiver will give optimum results. The transmitted pulses were very weak, being audible only as slight clicks, but the results were excellent.

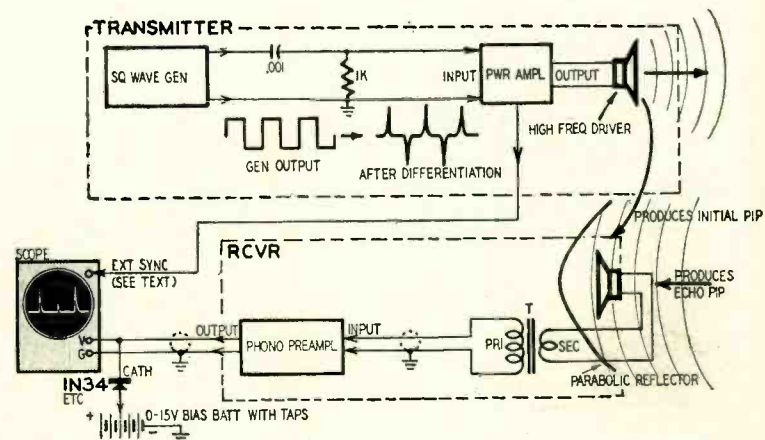

may be used for T to match the tweeter to the preamplifier input. The output of the preamp is connected to the vertical input of an oscilloscope, with a diode clamper to clip out the speaker hangover hash and extraneous room noises.

When the transmitter emits a pulse, it is almost immediately picked up by the receiver and a pip appears on the scope. When a reflected echo pulse returns from a wall or person, a second pip appears on the base line, just as in the early radar sets.

If only one driver unit is available, an ordinary microphone can be used for the receiver with a resulting loss in high-frequency efficiency and increased susceptibility to interference from room noises. Regular speakers could probably also be substituted for the drivers. A simple multivibrator could be used instead of a square-wave generator.

There are many possible modifications of this simple system, such as a rotator and radial sweep with . . . well, you get the idea! There may even be practical uses—who knows? **END**

what's

new

?

NEW DEPARTURE in telephone design and efficiency was introduced at the convention of the Independent Telephone Industry at Chicago recently. Originated by Ericsson (the Telephone Co. of Sweden) the new unit makes a clean break with hand-and-desk-set tradition. The dial in the base is thus in the most convenient position for use when the phone is picked up. The switch is in the center of the base, so the "receiver is hung up" when the set is replaced on the table or desk. Styling combines esthetics with efficiency, and the internal construction is likewise the result of a complete departure from tradition. The number of terminal screws and soldering points, for example, has been reduced by 50%. Even the cord is a new design, part being coiled and the section nearest the phone straight. The instrument is being manufactured in this country by North Electric Co. of Galion, Ohio.

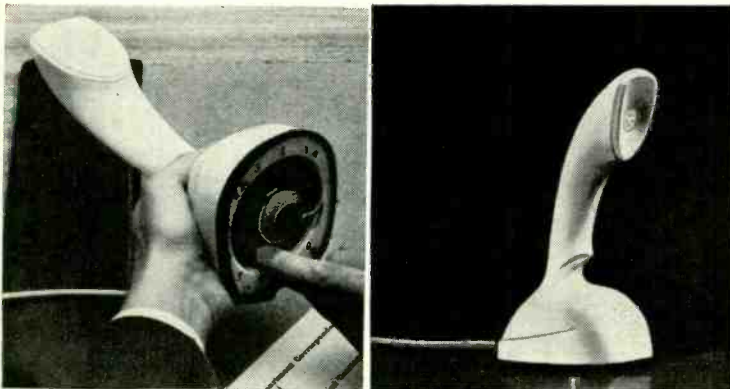

ELECTRONIC SNIFFER, used to detect minute quantities of gasses in the air, (RADIO-CRAFT, July 1948) has graduated from the class of interesting novelties to that of production tools. The gun here is checking for leaks in cans of compressed gasses, such as are now becoming common for insect sprays, varnishes and even as fuels for portable stoves. The sniffer depends on the change in ionization of the air between two of its electrodes, its conduction changing as changes in the composition of the air vary the ionization. The new sniffer is called the H-1 leak detector by its manufacturer, General Electric.

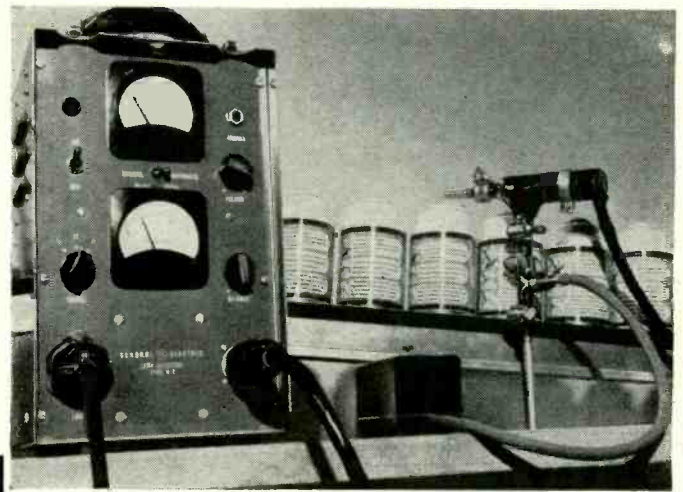

WONDERS OF RADIANT ENERGY

are depicted in this huge glass panel that represents the flow of energy from the Sun, storage of energy within the atom and its eventual release for man's use through nuclear reactions. The panel was designed for the Nuclear Energy Products division of American Car & Foundry by Tony D'Attilio in cooperation with ACF scientists and was executed by Harriton Carved Glass in New York. The 8 x 9-foot panel is now on a tour of educational and scientific institutions. On its return it will be set up permanently in the lobby of one of the two plants of the Nuclear Energy division, whose president, Rudolph Furrer, is shown admiring the panel.

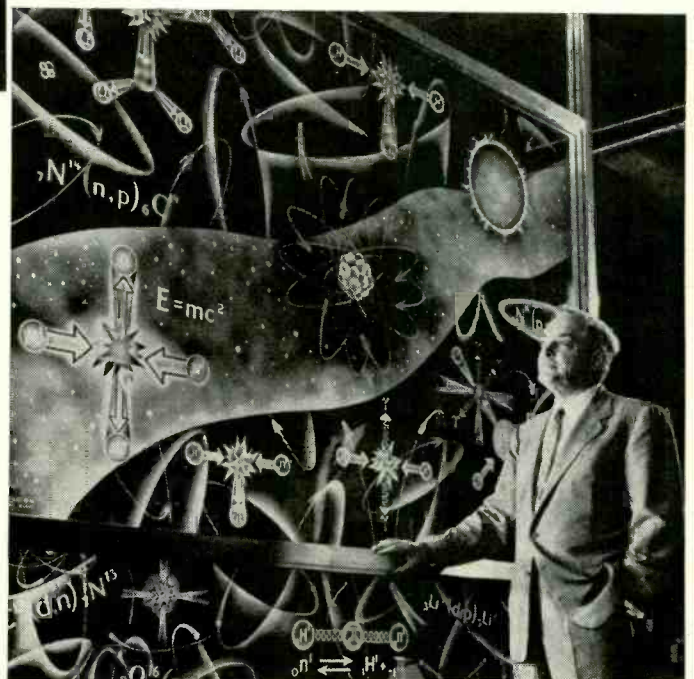

TRANSISTOR POWER is great enough to span the Atlantic. This was proven by three Massachusetts hams, who on Sept. 18 worked Denmark on a two-transistor transmitter. The three—Gus Fallgren and Al Hankinson of Raytheon's Missile Systems Laboratory in Bedford and Richard Wright, a student at Worcester Polytechnic Institute—operated from Fallgren's home in Chelmsford, Mass. The transmitter used two Raytheon 2N113/CK761 fusion-alloy transistors. No circuit information has been received to date, but from the photo it is almost obviously a crystal-controlled master-oscillator—power-amplifier setup. Contact was first established on the station's (W10GU) transmitter, after which the transmitting antenna was switched over to the transistor job. Besides the trans-Atlantic record, contacts include Birmingham, England; the two Carolinas, Ohio, Michigan, Illinois, Puerto Rico and Costa Rica. An Australian ham reported dubious reception of W10GU/transistorized, though QRM prevented confirmation. The operators' objective now is to work all continents on a transistor.

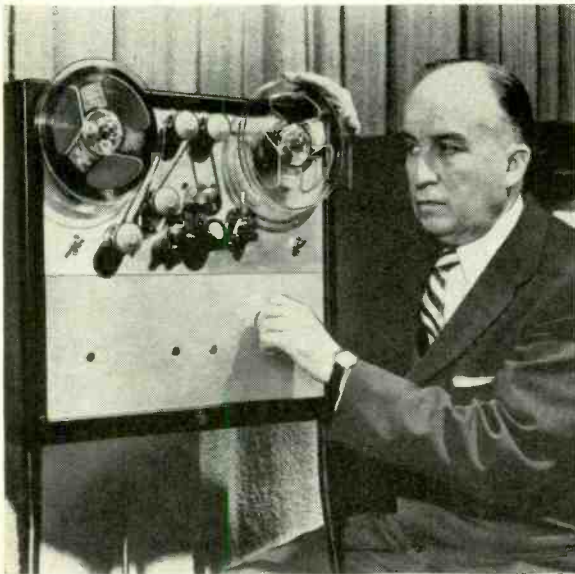

TELEVISION TAPE PLAYER

for home use is forecast by this development, one of the "birthday presents" tendered by the RCA laboratory at Princeton, N. J., to David Sarnoff on the 50th anniversary of the commencement of his radio career. Four connections are made from the tape player to the TV set, and a standard 7-inch reel will play 4 minutes (tape speed 10 feet per second). A double-track tape, playing 8 minutes, is expected in the near future. With the addition of a small amount of additional equipment, the player can also be used as a recorder to store programs from the TV for future playing and could also be used with a TV camera and microphone to make original recordings. Its present size and complexity are about equal to that of an ordinary television receiver. Queried as to its prospective availability, RCA spokesmen would not guess, but left a feeling that it would be marketed not earlier than 2 years or later than 5 years hence.

TELESCOPIC TRACKER,

which can hold a rocket fast jet in its sights at a distance of 300 miles and even fast enough to permit its operators to see a fast-moving artillery shell at closer ranges, has been developed by the Army Signal Corps. The object can not only be viewed but photographed automatically. Thus it can be used for study of the action of certain types of missiles as well as for following them. The device is designed to work in conjunction with radar apparatus and will assist in identifying objects which may look much alike on the radar screen but differ in appearance when viewed with the telescope. Telescope powers of 10, 20 and 40 are available and focal lengths of 160, 80, 40, and 20 inches.

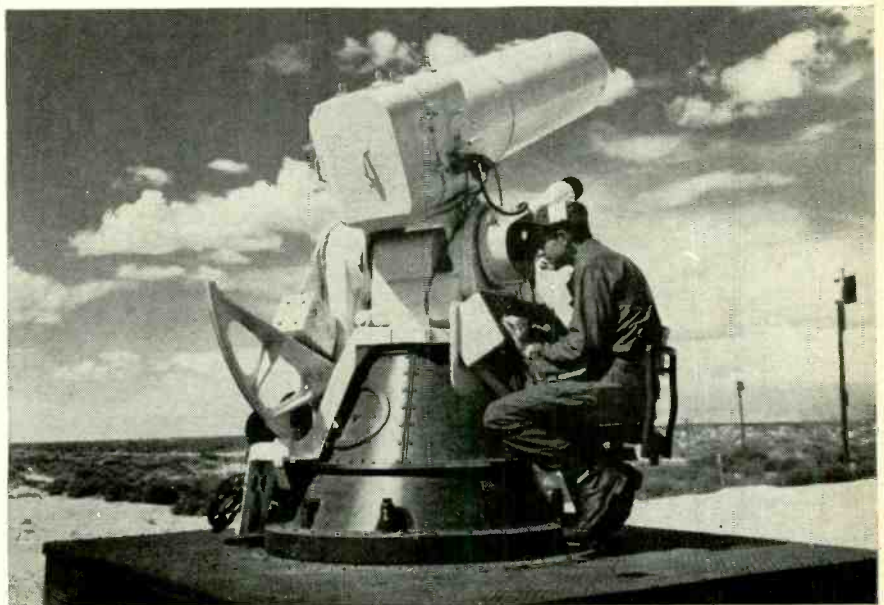

surge supply for INTERMITTENTS

By LYMAN E. GREENLEE

TRACKING down intermittents can certainly be classified as the toughest kind of receiver servicing. As an aid in speeding up this work I have developed a surge supply that applies excessive voltages for a short period of time. In a great many cases the higher voltage is sufficient to provide that little extra to break down the intermittent component, making it easier to locate.

Fig. 1 shows a simple power supply which provides a variable source of voltage up to 600 for surge checking and routine voltage overload testing. A conventional half-wave rectifier circuit is used. Voltage regulation is not necessary so a simple circuit can be used; one easily duplicated from junk box parts. The only nonconventional part is the 1,000-volt 1- μ f surge capacitor C3.

The 90-ohm 50-watt power rheostat in series with the power transformer serves as a fine voltage control. S2 acts as a low-high voltage switch by connecting either half or all of the transformer high-voltage winding into the circuit as required. The meter has a 500- μ a movement; other values would necessitate different voltage multiplier resistors. This meter is a surplus unit

with a dual scale reading 0-15 and 0-600 volts. It may be obtained at a low price and is very accurate. The power supply has two voltage ranges, 0-15 and 0-600.

The switching arrangement shifts the meter multiplier along with the voltage divider, but the 0-15 range is brought out to a separate pin to avoid the possibility of unintentionally applying high voltage to some part. This low-voltage range is useful primarily for checking low-voltage electrolytics and may be varied from about 1 to 15 volts as required. Note also the pilot lamps, one of which (PL2) may be used for continuity checking, and the pin jacks which provide an output of 6.3 volts ac for checking transformers, continuity of tube filaments, etc. Since the instrument provides a continuously variable, metered voltage output from about 1 to over 600 volts, capacitors can be checked for breakdown at their maximum voltage rating, electrolytics can be formed, resistors checked under load and surges applied to suspected parts.

The surge-check portion of the equipment consists of a 1- μ f 1,000-volt oil-filled capacitor connected to S4. To use, one test lead is the common (ground)

wire, the other goes to the pin jack connected to S4. When the test leads are connected across a component on the chassis, flipping S4 alternately charges the 1- μ f capacitor to the metered voltage output and then discharges it through the suspected part. Several surges can be applied in a very short time by working the switch back and forth. A surge discharge is most useful in causing intermittent capacitors, resistors, chokes, yokes and transformers to break down completely so that they may be located and removed.

There are a few precautions to observe. Take care to avoid damage to certain critical parts like the filaments of tubes in portables (remove all tubes before applying a surge to any parts), transistors, diodes, low-voltage electrolytics and transformers wound with extremely fine wire. Fuses can also be damaged. Keep away from parts that could be ruined by a voltage surge or adjust the charging voltage to a safe level. If voltages are kept low enough there will be no danger of damage to such parts.

A lot of experimenting has indicated that 1 or 2 μ f is about the right capacitance to give an adequate surge for checking and still stay within limits safe for most components. Higher capacitances may be used in special cases.

Be sure to keep the surges through transistors and diodes below their maximum rated operating voltage. Applying surges to suspected diodes or transistors is permissible and is in fact a good method of checking these parts if they are suspected of being intermittent.

Simple surge checking can be done with a few spare capacitors of various values, using a set's power supply as voltage source. However, a separate power supply is more convenient. And when equipped with a meter and some method of varying the output voltage, it becomes more accurate and there is so much less danger of damage to critical parts because the charging voltages can be adjusted to conform to the maximum rating of the parts under test.

Most surge checking can be done with the chassis disconnected from the power line. Actually, the method is specifically applicable to cold checking of a chassis with tubes removed, and this is the way it should be used. Surge checking will show up defective parts

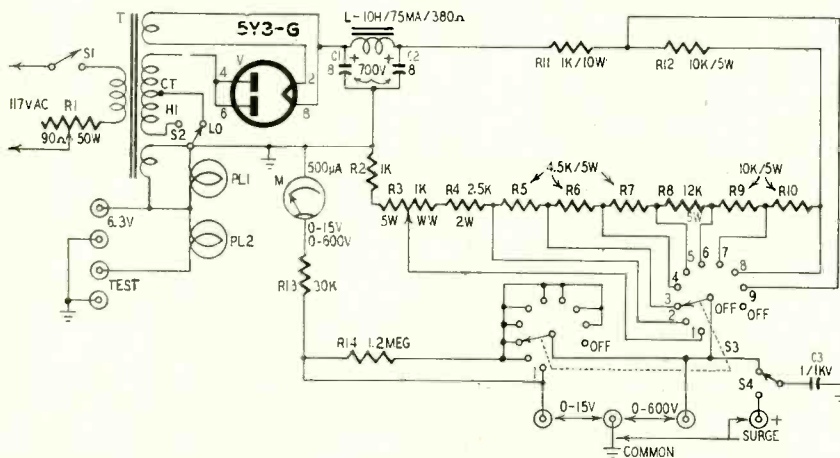

- R1—90-ohm 50-watt rheostat
- R2—1,000 ohms, 1/2 watt
- R3—1,000 ohms, 5 watts, wirewound pot
- R4—2,500 ohms, 5 watts
- R5, 6, 7—4,500 ohms, 5 watts
- R8—12,000 ohms, 5 watts
- R9, 10, 12—10,000 ohms, 5 watts
- R11—1,000 ohms, 10 watts
- R13—30,000 ohms (use 12,000 plus 18,000 ohms), 1/2 watt
- R14—1.2 megohms, 1/2 watt
- C1, 2—8 μ f, 700 volts, electrolytic
- C3—1 μ f, 1,000 volts, oil filled
- L—10 henries @ 75 ma, 380 ohms (see T for current rating)

- V—5Y3-G
- Octal socket for V
- M—0.5 ma (500 μ a) meter (see text)
- S1—spst switch
- S2, 4—spdt switch
- S3—2-pole 10-position rotary switch
- T—power transformer, approximately 600 volts ct @ 100 ma (use higher-current secondary if unit is to be used as conventional power supply), 5 volts @ 2 amps, 6.3 volts @ 1 amp or more (depending upon use of unit)
- PL1, 2—6.3-volt pilot lamps and assemblies
- Pin jacks (8)
- Chassis
- Cabinet

Fig. 1—Schematic diagram of the 600-volt power supply for overload testing.

that might not otherwise break down for days or even weeks of normal routine checking, overloading, heating, pounding, hammering, squeezing and mauling as ordinarily performed by the technician when dealing with an intermittent. Since the surges can be confined to specific parts and locations there is not the same chance of damage to perfectly good components as with the line voltage set at—say—150 volts, for long periods of cooking and overload checking.

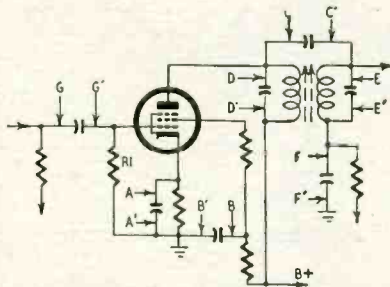
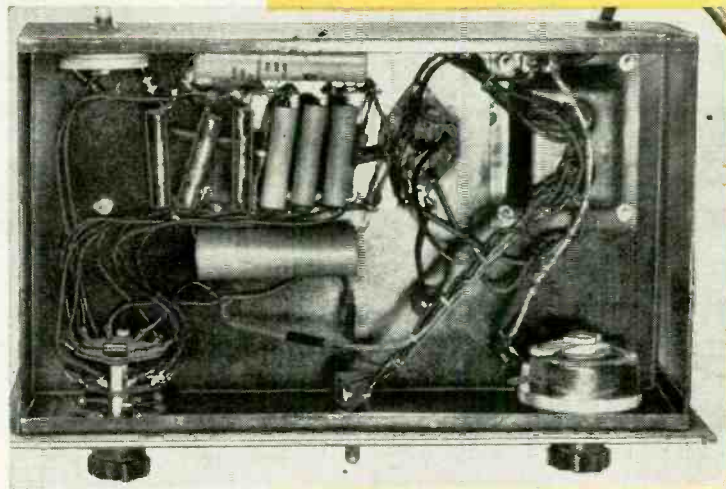

Fig. 2—Typical amplifier circuit with points indicated for surge testing.

Fig. 2 shows a typical amplifier stage and the various points where the surge voltage may be applied. Surge capacitor C3 may be charged to 50 volts and applied across A-A'; charged to 400 volts and placed across B-B', D-D', E-E' and F-F'; charged to 600 volts and discharged across points C-C' and G-G'.

To check resistors, charge the surge capacitor to the required voltage and connect across the suspected resistor. For example, connect between points G' and A' to check grid resistor R1. Good resistors will not be harmed by a surge from a 1- μ f capacitor regardless of the voltage used. **END**



Underchassis wiring of the supply.

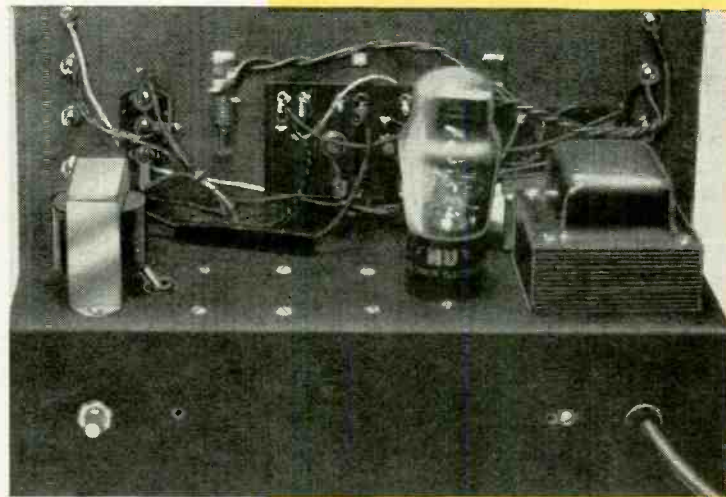

Rear view of unit—surge capacitor is behind the power transformer.

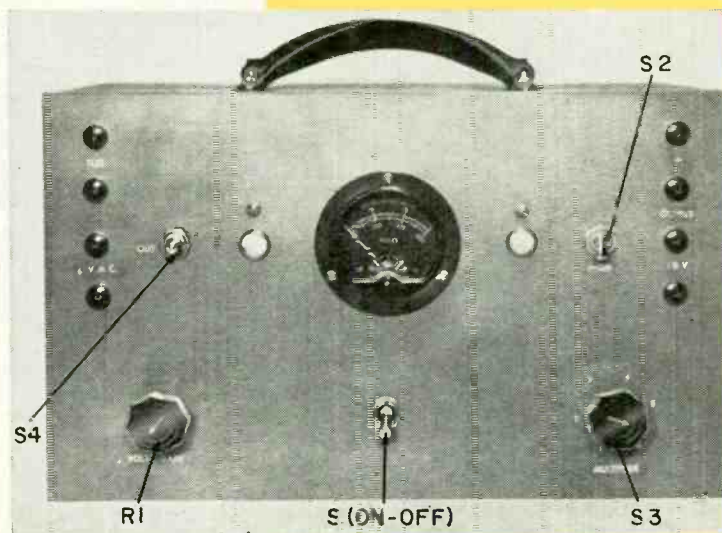

Front panel view of the surge supply.

TRANSISTORIZED

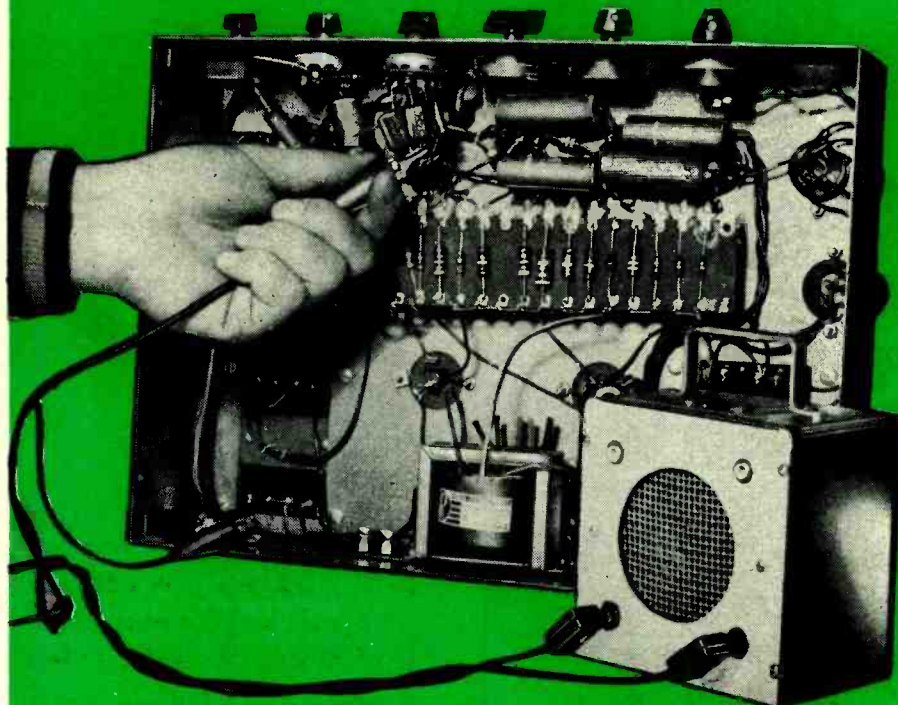

**audio
amplifier—
audio tester**

*Small transistorized unit
is built around
3-inch speaker*

By HOMER L. DAVIDSON

THIS transistorized amplifier was built around a small 3-inch PM speaker, chosen because of its availability and compactness. As is, the unit measures 4½ by 4 inches and is 2½ inches deep.

Two Raytheon CK722 transistors were used in cascade. The small amplifier can be used for many things: as an audio amplifier for crystal receivers or small 1- or 2-tube receivers. It is also being used to trace audio signals through radio, television and auto radios. By adding a small rf probe, as described later, rf can be traced through radio receiving equipment.

The circuit (Fig. 1) is easy to follow, only a few components are used. A .01- μ f paper capacitor couples the input signal to the base of V1. Resistor R1 is a 2.2-megohm base return that develops correct bias for the first audio stage. There are two input jacks of different types to inject the input signal. One input consists of two small tip jacks, one black the other red. The other input connection was placed on the amplifier so that phonograph changers could be easily plugged in while working on them. This input is a regular phono jack. The collector terminal of V1 feeds the primary of a push-pull interstage transformer. The secondary is coupled to a 25- μ f low-voltage electro-

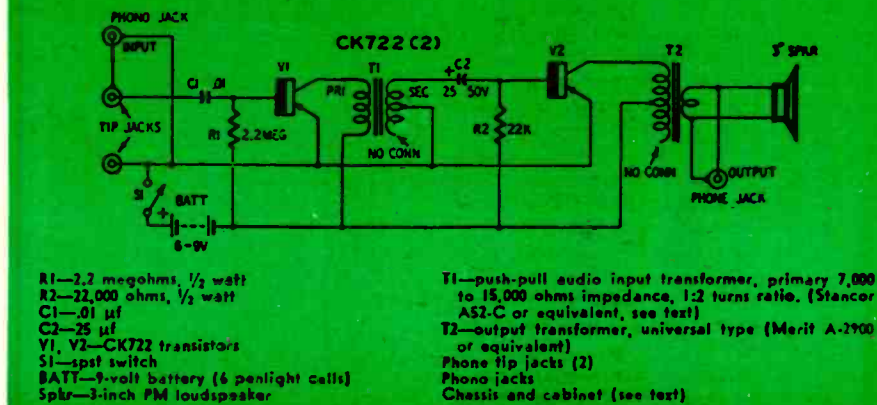

Fig 1—The amplifier-audio tester uses two transistors.

lytic. By experiment, a better matching resulted when only one half of this transformer was used. A 22,000-ohm resistor was used as a bias return for V2.

These small transistors should never pull over 5 ma and, by using a variable resistor in the original circuit, these fixed resistors were chosen for correct amplification and current drain. V1 draws only 1.5 ma while the last audio output stage draws 4 ma. To match the output of V2 correctly to the output transformer a small universal type was chosen. Again only one half on the

primary was used while the other end was cut off and taped. The secondary of output transformer T2 can be soldered into the circuit. Also in the secondary was placed an output jack, another female phono plug. This was used to check the output of auto receivers that were pulled, with the original speaker left in the car. It can also be used to replace any PM speaker. Both emitter terminals are soldered directly to ground or to a common tie point.

Before mounting the parts the speaker was prepared. The four speaker mounting holes were drilled

Closeup of simple tester.

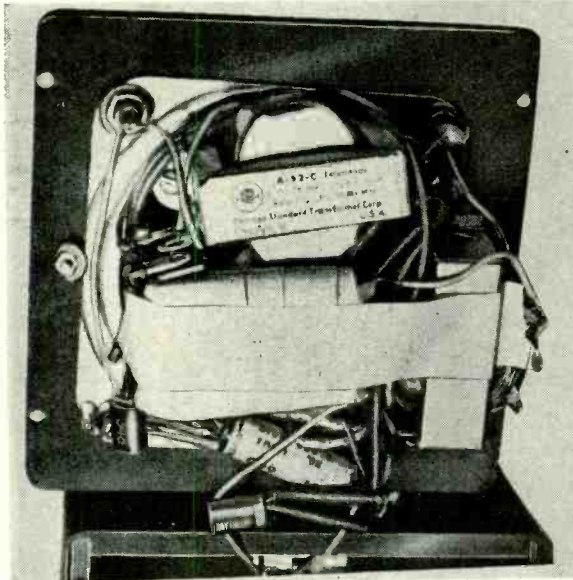

Parts layout of the amplifier. Speaker forms chassis for entire unit.

and enlarged to $\frac{1}{4}$ inch in diameter. In the bottom two holes, two small phone jacks were installed. The black jack was tightened directly to the speaker frame and used as a common or grounding point. The red jack was insulated from the metal speaker frame with insulation washers. In the two top holes the phono jacks were mounted. A piece of spaghetti was placed over the center terminal so it would not short against the metal frame. The grounding lugs were soldered directly to the speaker.

The two transformers were mounted on separate metal frames and held into place by the black grounding jack. Then two or three insulated standoff lugs were soldered to the outside edges of each transformer. On these lugs the transistors were soldered and mounted into place. Again insulated spaghetti was placed over the transistor leads so that they would not short. The transistor leads were not cut but soldered directly into the circuit. The base-return resistors were mounted as they were hooked up. The small battery supply was made up of six small penlight cells, 9 volts. They were soldered in series and then taped. A spst sliding type switch was used to turn the small amplifier on and off.

The amplifier was mounted in a home-made wooden cabinet. The sides were cut out of $\frac{1}{4}$ -inch plywood and nailed

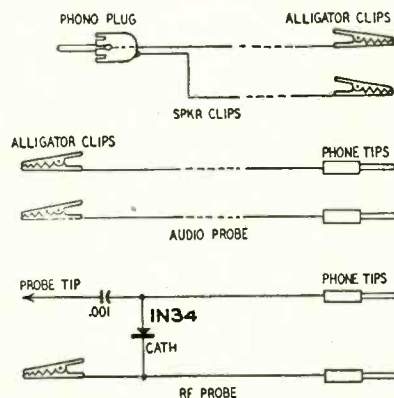

Fig. 2—Leads and probe for use with the amplifier tester.

together with small brads. Both front and bottom panels were sawed from Masonite, cut and drilled, and then screwed to the wood frame. A small handle was added for carrying convenience.

A small rf probe can be constructed, as shown in Fig. 2, to signal-trace through rf and if stages. Another set of leads were made up of pin jacks on one end and alligator clips on the other. For the voice-coil output jack a male phono plug was soldered to two test leads with alligator clips at the other end. END

For Your Convenience

With the growing interest in construction—largely inspired by the transistor—RADIO-ELECTRONICS is including a larger number of construction articles. To make life easier for constructors (though hardly for the editors!), we are increasing the amount of information given in schematics and photographic illustrations.

● **SCHEMATICS** will generally have all parts coded (R1, C2, etc.), in addition to our long-time practice of having the value noted next to the part.

● **CODED PARTS LIST** will also be furnished. This should settle such parts list questions as: which of the five 100 K-ohm resistors specified are $\frac{1}{2}$ watt, 1 watt and 2 watt?

● **PHOTOGRAPHS** will have many more call-outs than in the past, to eliminate difficulties which might result from parts placement different from the original constructor's and to make parts location obvious without need for careful study.

Let us know what you think of these steps, and what others should be taken to help the reader make better use of his magazine.

SCOPE

delivers audio test signal

Simple scope modification permits testing amplifier frequency response and stability

By CHARLES F. WOLF

A SAWTOOTH-voltage sweep generator is very useful in amplifier testing. Many circuits for this have appeared. However, if one has an oscilloscope, the sweep generator therein may easily be used when it is calibrated and an output terminal provided.

Fig. 1 is a schematic for modifying a Heath model O-8 oscilloscope to provide a sawtooth output. Here the output is tapped off at the cathode and plate pins of the horizontal phase-splitting tube. A spdt switch (with a center off position) is used to give positive or negative pulses, positive from the plate and negative from the cathode. A 20,000-ohm potentiometer provides a variable output, the maximum being 5 volts, peak to peak.

The sweep generator is calibrated as shown in Fig. 2 by plotting the frequency against the setting of the FREQ. VERNIER control, using semilog graph paper. A scope that has voltage regulation (as the O-8) will have very good sweep-frequency stability. However, without voltage regulation the frequency will be stable enough for most testing purposes.

When this modification is made on another type scope, the value of the potentiometer should be made as low as possible without loading the phase-splitting tube too much. A value that decreases the sawtooth voltage by about a 5% maximum is tolerable.

In Fig. 3 the spdt switch and potentiometer are shown mounted between the HOR. GAIN control and the FREQ. SELECTOR knobs. The output jack is mounted in the lower right-hand corner between the 60 CY. TEST and GROUND jacks.

The 60-cycle test can be used for calibrating the lower-frequency ranges of the sweep generator. This is done in a manner somewhat similar to that of using Lissajous patterns except that we have here a sine wave and a sawtooth wave (not two sine waves, as with Lissajous figures).

Oscilloscope patterns

In Fig. 3, the pattern on the scope screen is formed by a sine wave applied

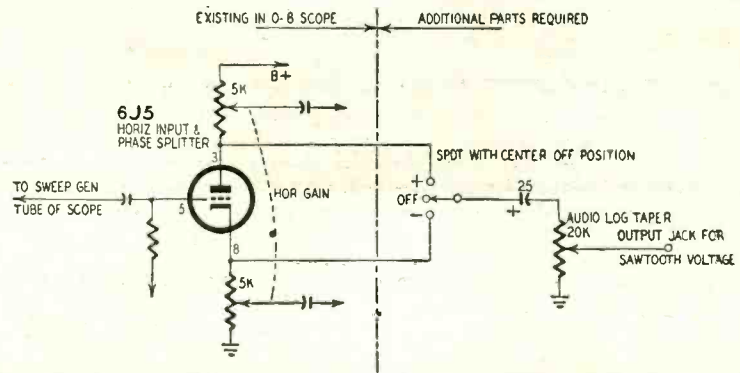

Fig. 1—Scope modification for providing sawtooth voltage output.

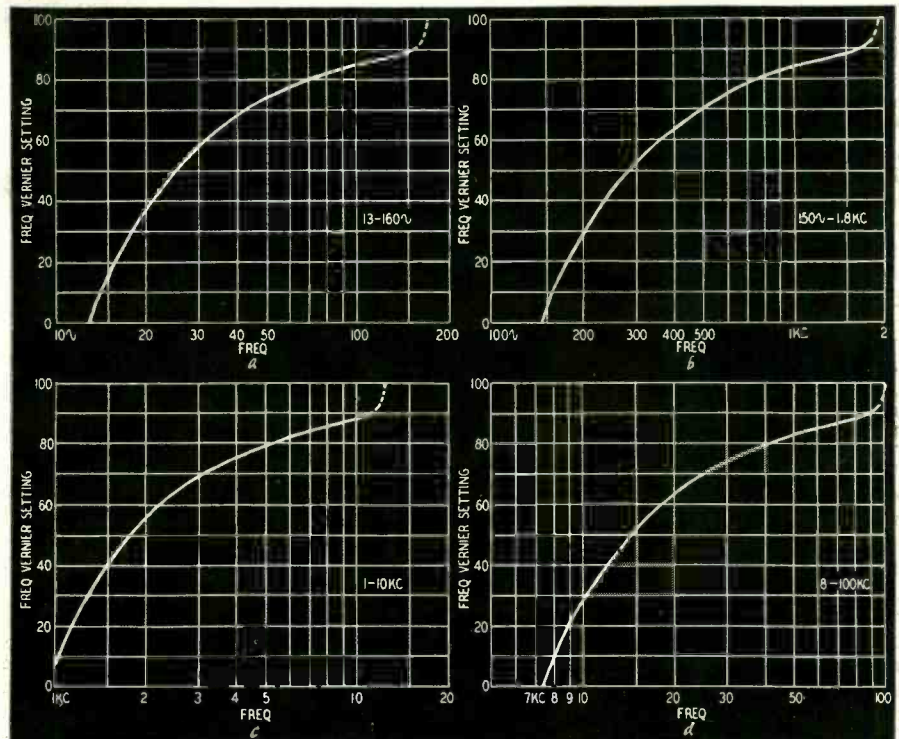

Fig. 2—Charts show generator frequency calibrated against vernier setting.

to the vertical plates of the scope and a sawtooth wave to the horizontal plates. When the sine wave is 60 cycles, the frequency of the sawtooth wave can be determined by the formula:

$$f = \frac{\text{separate traces} \times 60}{\text{horizontal intersections}}$$

Separate traces means the number of distinctly separate traces that can be counted; three in this case, being easiest to count in a vertical line.

Horizontal intersections means the number of intersections that can be counted in one horizontal straight line—four in this case.

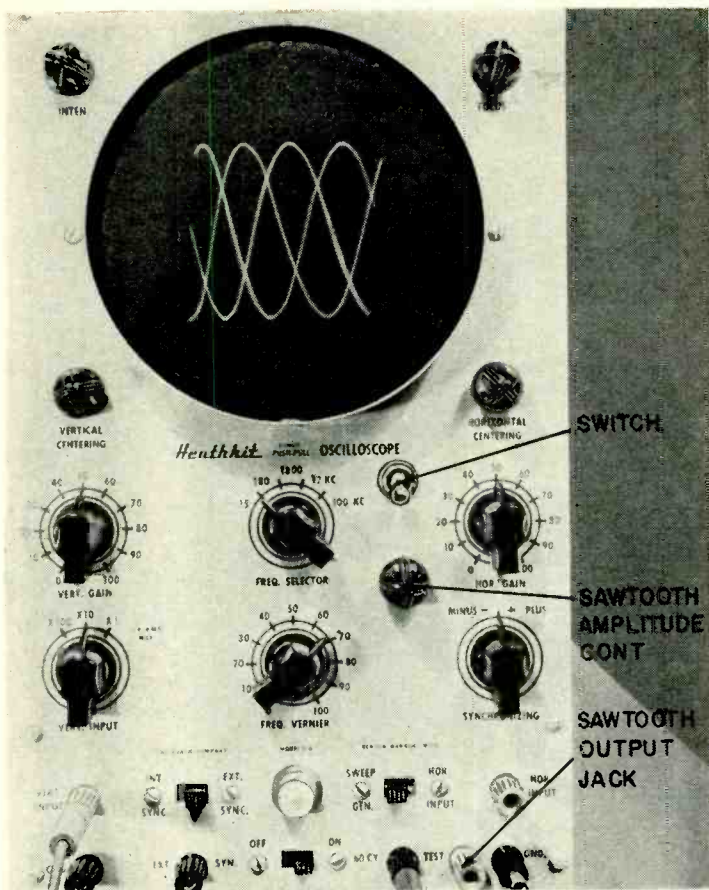

Fig. 3—Oscilloscope panel showing switch, potentiometer and output jack.

Thus in Fig. 3 the frequency of the sawtooth wave is:

$$f = \frac{3 \times 60}{4} = 45 \text{ cycles}$$

Fig. 4 shows the very familiar 120-cycle sawtooth trace, or as expressed according to the formula:

$$f = \frac{2 \times 60}{1} = 120 \text{ cycles}$$

Fig. 5 shows an 80-cycle sawtooth. This method can also be used for setting exactly and simply the sweep-generator frequency to one of many fractional multiples of the frequency of the sine wave that is applied to the vertical amplifier plates. When 60 cycles is used, the sweep generator can be set to any one of these values, up to about 600 cycles.

A correspondingly higher steady sine-wave source is used to calibrate the higher ranges of the sweep generator. When the calibration of the various ranges has been accurately carried out, the curves for the various ranges will have almost exactly the same shape (see Fig. 3) and form, except that they will be shifted with respect to frequency.

In calibrating a scope sweep generator, the synchronization switch must be turned off as any sync applied to the sweep tube will throw the calibration completely off. With synchronization the sweep generator is able to produce the same frequency for different settings of the frequency vernier control.

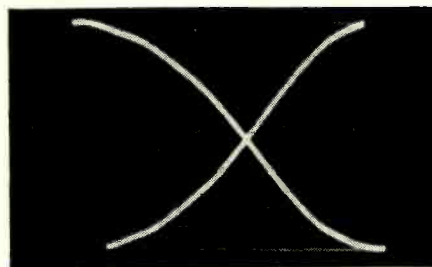

Fig. 4—60 cycles applied to vertical input—sawtooth frequency 120 cycles.

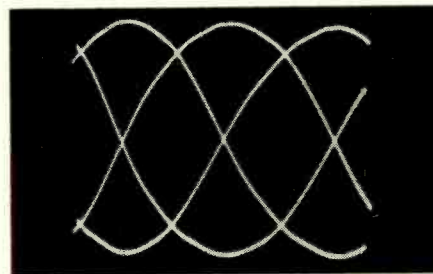

Fig. 5—60 cycles applied to vertical input—sawtooth frequency 80 cycles.

Generator applications

Besides being used to determine the frequencies of waveforms using the above methods, the generator has two important other uses: testing frequency response and amplifier stability.

When checking frequency response, the sawtooth wave is applied to the input of the amplifier or system under test and the output is viewed on the scope, using the vertical input terminals. When used in this way, the sweep generator of the scope performs two

functions—a horizontal sweep for the scope pattern and a test signal. If the system being tested reproduces the sawtooth wave perfectly, the resulting pattern on the scope screen will be a straight line slanting up or down from left to right, depending upon the polarity of the sawtooth wave used.

Also, if the sawtooth wave is reproduced perfectly, then the frequency response of the system under test will be flat from approximately 0.1 to 10 times the base frequency of the sawtooth wave being used. For example, an amplifier which reproduces perfectly 100-, 1,000- and 10,000-cycle sawtooth waves is flat from 10 to 100,000 cycles. To get this data using sine-wave signals would take quite a bit of time whereas with sawtooth waves we have to use only three frequencies.

In testing for amplifier stability and transient response the sawtooth wave is a bit better than the square wave because a square wave will fail to show overloading while the top of a sawtooth wave will be clipped off at the point where overloading occurs. Instability or poor transient response is shown on a sawtooth wave by parasitic oscillation on the front part of the waveform. In testing for stability, slowly sweep the sawtooth generator through its entire frequency range a number of times, each time varying the voltage of the sawtooth wave, starting with very low values and working up to the point of amplifier overloading. Sometimes an amplifier will show instability at low levels but not at high, and vice versa. An amplifier that passes

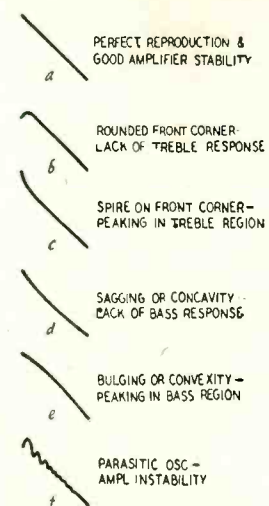

Fig. 6—Oscilloscope waveforms and the amplifier defects they indicate.

this test can be judged extremely stable.

Fig. 6 is a list of oscilloscope diagrams of the various symptoms and causes as displayed by the sawtooth wave. Only one period of the wave is shown as this is how it will look when the same sawtooth wave is used as horizontal sweep and test signal. END

References

R. C. Hitchcock, "Testing With White Sound," *Audio Engineering*, October, 1954.
 J. C. Arnold, "Check Audio Response With a Neon Glow Tube," *RADIO-ELECTRONICS*, November, 1952.

New



MODEL O-11

Shpg. Wt.
21 Lbs.

\$69⁵⁰

- * An improved model of what was already an outstanding instrument.
- * Performance is unmatched in this price range.
- * Incorporates the extra features required for color TV servicing.

Extra!

A FULL YEAR TO PAY

SEND FOR DETAILS OF HEATH
TIME-PAYMENT PLAN.

**5
BIG
REASONS
WHY**



**HEATH
COMPANY**

A SUBSIDIARY OF DAYSTROM, INC.

BENTON HARBOR 20, MICH.

HEATHKIT ETCHED CIRCUIT, PUSH-PULL

5" Oscilloscope Kit COLOR TV

The previous Heathkit oscilloscope (Model O-10) which was already a most remarkable instrument, has been improved even further with the release of the Heathkit Model O-11. It incorporates all the outstanding features of the preceding model, *plus* improved vertical linearity, better sync stability, especially at low frequencies, and much-improved over-all stability of operation, including less vertical bounce with changes in level. These improvements in the Model O-11 circuit make it even more ideally suited for color TV servicing, and for critical observations in the electronic laboratory. Vertical response extends from 2 CPS to 5 MC without extra switching. Response only down 1½ DB at 3.58 MC. The 11-tube circuit features a 5UP1 cathode-ray tube. Sync circuit functions effectively from 20 CPS to better than 500 kc in five steps. Modern etched circuit boards employed in the oscilloscope circuit cut assembly time almost in half, permit a level of circuit stability never before achieved in an oscilloscope of this type, and insure against errors in assembly. Both vertical and horizontal output amplifiers are push-pull. Built-in peak-to-peak calibrating source — step-attenuated input — plastic molded capacitors and top-quality parts throughout — pre-formed and cabled wiring harness — and numerous other "extra" features. A professional instrument for the serveshop or laboratory. Compare its specifications with those of scopes selling in much higher price brackets. You can't beat it!

1 FEWER DOLLARS BRING MORE REAL QUALITY.

- Factory-to-you sales eliminate extra profit margin.
- "Build-it-yourself" eliminates labor charge.
- Heath purchasing power cuts component costs.

2 PERSONAL SERVICE ASSURES CUSTOMER SATISFACTION.

- You deal directly with the manufacturer.
- We are interested in you before and after sale.

Heathkits®

ARE YOUR BEST BUY...

3 PROVEN DESIGNS MEAN RELIABLE PERFORMANCE.

- Research and development efforts concentrated on kits only.
- All kits guaranteed to meet advertised specifications.

4 EVERY KIT BACKED BY WORLD-WIDE REPUTATION.

- The world's largest manufacturer of electronic equipment in kit form.
- Producer of more than a million electronic kits for the home workshop and industry.

5 EASY TIME-PAYMENT PLAN TO FIT YOUR BUDGET.

New HEATHKIT ETCHED CIRCUIT 5" Oscilloscope Kit

GREATEST SELECTION . . .

Whether your particular special interest is in servicing, ham-radio, high-fidelity, or just experimenting—there are Heathkits to fill your needs. You can equip an entire service shop or lab, buy a complete ham station or high-fidelity system, or set up a really deluxe home workshop, by choosing from the more than 70 different "do-it-yourself" electronic kits by Heath. Just glance through the kits displayed in this ad, and you will get some idea of the tremendous array of low-priced, high-quality electronic equipment available.

- * Brand new model with improved performance specifications.
- * Full 5" scope for service work at a remarkably low price.
- * Attractively styled front panel in charcoal gray with sharp white lettering.
- * Easy to build from step-by-step instructions and large pictorials. Not necessary to read schematic.

This new and improved oscilloscope retains all the outstanding features of the preceding model, but provides wider vertical frequency response, extended sweep-generator coverage, and increased stability. A new tube complement and improvements in the circuit make these new features possible. Vertical frequency response is essentially flat to over 1 mc, and down only 1½ DB at 500 kc. The sweep generator multivibrator functions reliably from 30 to 200,000 CPS, almost twice the coverage provided by the previous model. Deflection amplifiers are push-pull, and modern etched circuits are employed in critical parts of the design. A 5BP1 cathode-ray tube is used. The scope features external or internal sweep and sync, one volt peak-to-peak reference voltage, 3-position step-attenuated input, adjustable spot-shape control, and many other "extras" not expected at this price level. A calibrated grid screen is also provided for the face of the CRT, allowing more precise observation of wave shapes displayed. The new Model OM-2 is designed for general application wherever a reliable instrument with good response characteristics may be required. Complete step-by-step instructions and large pictorial diagrams assure easy assembly.



MODEL OM-2

\$42⁵⁰

Shpg. Wt.
21 Lbs.

HEATHKIT LOW CAPACITY PROBE KIT

Oscilloscope investigation of high frequency, high impedance, or broad bandwidth circuits encountered in television requires the use of a low-capacity probe to prevent loss of gain, circuit loading, or waveform distortion. The Heathkit low-capacity probe may be used with your oscilloscope to eliminate these effects. It features a variable capacitor, to provide correct instrument impedance match. Also, the ratio of attenuation can be varied.

No. 342

\$3⁵⁰

Shpg. Wt. 1 Lb.

HEATHKIT ELECTRONIC SWITCH KIT

This handy device allows simultaneous oscilloscope observation of two signals by producing both signals, alternately, at its output. It features an all-electronic switching circuit, with no moving parts. Four switching rates are selected by a panel switch. Provides actual gain for input signals, and has a frequency response of ± 1 DB from 0 to 100 kc. Sync output provided to control and stabilize scope sweep. Will function at signal levels as low as 0.1 Volt. This modern device finds many applications in the laboratory and service shop. It employs an entirely new circuit, and yet is priced lower than its predecessor.

MODEL S-3

\$21⁹⁵

Shpg. Wt. 8 Lbs.

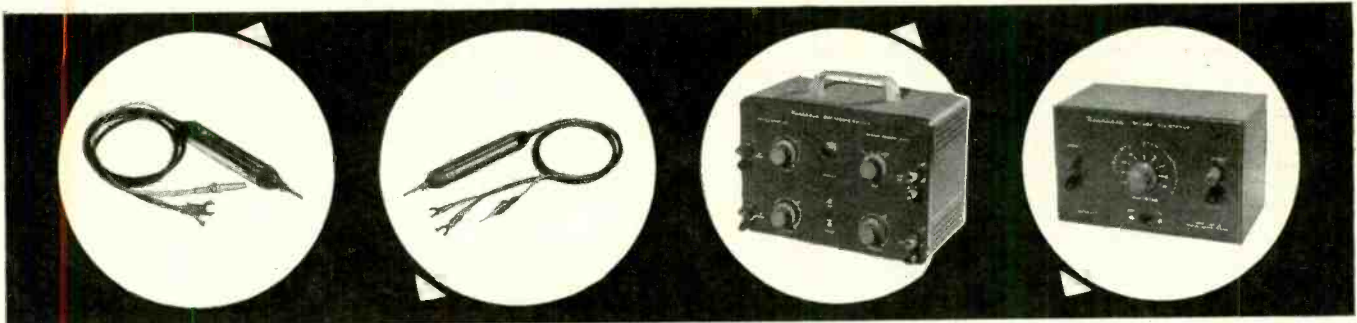

HEATHKIT SCOPE DEMODULATOR PROBE KIT

Extend the usefulness of your oscilloscope by employing this probe. Makes it possible to observe modulation of RF or IF carriers found in TV and radio receivers. Functions much like an AM detector to pass only modulation of signal, and not the signal itself. Among other uses, it will be helpful in alignment work, as a signal tracer, and for determining relative gain. Applied voltage limits are 30 volts (RMS) and 500 volts DC. It uses an etched circuit board to simplify assembly.

NO. 337-C

\$3⁵⁰

Shpg. Wt. 1 Lb.

HEATHKIT VOLTAGE CALIBRATOR KIT

This entirely new voltage calibrator produces near-perfect square wave signals of known amplitude. Precision 1% attenuator resistors assure accurate output amplitude, and multivibrator circuit guarantees good, sharp square waves, as distinguished from clipped sine waves. Output frequency is approximately 1000 CPS. Fixed outputs selected by panel switch are: .03, 0.1, 0.3, 1.0, 3.0, 10, 30, and 100 volts peak-to-peak. Allows measurement of unknown signal amplitudes by comparing to known peak-to-peak output of VC-3 on an oscilloscope. Will also double as a square wave generator at 1000 cycles for determining gain, frequency response, or phase-shift characteristics of audio amplifiers. Equally valuable in the laboratory or in radio and TV service shops.

MODEL VC-3

\$12⁵⁰

Shpg. Wt. 4 Lbs.

HEATHKIT ETCHED CIRCUIT VACUUM TUBE



MODEL
V-7A

\$24⁵⁰

Shpg. Wt.
7 Lbs.

- * Easy to build — a pleasure to use.
- * 1% precision resistors employed for high accuracy.
- * Etched circuit board cuts assembly time in half.

Voltmeter Kit

The fact that this instrument is the world's largest-selling VTVM says a great deal about its accuracy, reliability, and overall quality. The V-7A is equally popular in the laboratory or service shop, and represents an unbelievable test equipment bargain, without a corresponding sacrifice in quality. Its appearance reflects the performance of which it is capable. A large 4½" panel meter is used for indication, with clear, sharp calibrations for all ranges. Front panel controls consist of a rotary function switch and a rotary range selector switch, zero-adjust, and ohms-adjust controls. Precision 1% resistors are used in the voltage divider circuits and etched circuits are employed for most of the circuitry. This makes the kit much easier to build, eliminates the possibility of wiring errors, and assures duplication of laboratory instrument performance. This multi-function VTVM will measure AC voltage (rms), AC voltage (peak-to-peak), DC voltage, and resistance. There are 7 AC (rms) and DC voltage ranges of 0-1.5, 5, 15, 50, 150, 500, and 1500. In addition, there are 7 peak-to-peak AC ranges of 0-4, 14, 40, 140, 400, 1400, and 4000. 7 ohmmeter ranges provide multiplying factors of X1, X10, X100, X1000, X10K, X100K, and X1 megohm. Center-scale resistance readings are 10, 100, 1000, 10K, 100K ohms, 1 megohm, and 10 megohms. A DB scale is also provided. The precision and quality of the components used in this VTVM cannot be duplicated at this price through any other source. Model V-7A is the kind of instrument you will be proud to own and use.

HEATHKIT Etched Circuit RF PROBE KIT

This RF probe extends the frequency response of any 11-megohm VTVM so that it will measure RF up to 250 megacycles within ± 10%. Employs printed circuits for increased stability and ease of assembly. Ideal for extending service and laboratory applications of your Heathkit VTVM. No. 309-C

\$3⁵⁰

Shpg. Wt. 1 Lb.

HEATHKIT 20,000 OHMS/VOLT VOM KIT

Sensitivity of this instrument is 20,000 ohms-per-volt DC and 5,000 ohms-per-volt AC. Measuring ranges are 0-1.5, 5, 50, 150, 500, 1500, and 5000 volts for both AC and DC. Also measures current in the ranges of 0-150 microamperes, 15 ma, 150 ma, 500 ma, and 15 a. Resistance ranges provide multipliers of X1, X100, and X10,000, resulting in center scale readings of 15, 15,000, and 150,000 ohms. DB ranges cover from -10 db to +65 db. Housed in attractive black bakelite case with plastic carrying handle, this fine instrument provides a total of 25 meter ranges on its two-color scale. It employs a sensitive 50 microampere, 4½" meter and features all 1% precision multiplier resistors. Requires no external power, and is, therefore, valuable in portable applications where no AC power is available. MODEL MM-1

\$29⁵⁰

Shpg. Wt. 6 Lbs.

HEATHKIT SCOPE DEMODULATOR PROBE KIT

This probe functions like an AM detector to pass only modulation of signal and not signal itself. Permits observation of modulation from RF or IF carriers in TV and radio receivers. Extends usefulness of your oscilloscope. Voltage limits are 30 V. rms, and 500 V. DC. Very valuable in service or laboratory applications. No. 337-C

\$3⁵⁰

Shpg. Wt. 1 Lb.



HEATHKIT 30,000 VOLT DC HIGH VOLTAGE PROBE KIT

This probe provides a multiplication factor of 100 on the DC ranges of the Heathkit 11-megohm VTVM. Precision multiplier resistor mounted inside the two-color plastic probe body. Plenty of insulation for completely safe operation, even at highest TV potentials. Designed especially for TV service work. No. 336

\$4⁵⁰

Shpg. Wt. 2 Lbs.

HEATHKIT HANDITESTER KIT

The Model M-1 measures AC or DC voltage at 0-10, 30, 300, 1000, and 5000 volts. Direct current ranges are 0-10 ma, and 0-100 ma. Ohmmeter ranges are 0-3000 (30 ohm center scale) and 0-300,000 ohms (3,000 ohms center scale). Uses a 400 microampere meter for sensitivity of 1000 ohms-per-volt. A very popular test device for the home experimenter, electricians, and appliance repairmen, and for use as an "extra" instrument in the service shop. Its small size and rugged construction make it perfect for any portable application. Easily slips into your tool box, glove compartment, coat pocket, or desk drawer. Top quality, precision components employed throughout. MODEL M-1

\$14⁵⁰

Shpg. Wt. 3 Lbs.



HEATH COMPANY
A Subsidiary of Daystrom, Inc.
BENTON HARBOR 20, MICH.

CONTROLLED QUALITY . . .

Incoming parts inspection, and inspection of material coming off of our own production line assures you of the finest "build-it-yourself" kit that money can buy. Each kit contains all the components you need for assembly—and you can have confidence in the quality of the parts themselves. In addition to this inspection procedure, an extensive proof-building program for each new kit guarantees easy-to-follow instructions and reliable performance.

HEATHKIT NEW AUDIO VACUUM TUBE

Voltmeter Kit

- * Brand new circuit for extended frequency response and added stability.
- * Ten accurate ranges from 0-.01 to 0-300 volts.
- * Modern, functional panel styling. "On-off" switch at both extreme ends of range switch.

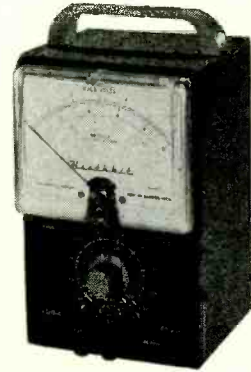

MODEL AV-3
\$29⁹⁵

Shpg. Wt.
5 Lbs.

This brand new AC vacuum tube voltmeter emphasizes stability, broad frequency response, and sensitivity. It is designed especially for audio measurements, and low-level AC measurements in power supply filters, etc. Employs a cascode amplifier circuit with cathode-follower isolation between the input and the amplifier, and between the output stage and the preceding stages. An extremely stable circuit with high input impedance (1 megohm at 1000 CPS). Response of the AV-3 is essentially flat from 10 CPS to 200 kc, and is usable for tests even beyond these frequency limits. Increased damping in the meter circuit stabilizes the meter for low frequency tests. Nylon insulating bushings at the input terminals reduce leakage, and permit the use of the 5-way Heath binding post.

The extremely wide voltage range covered by the AV-3 makes it especially valuable not only in high-fidelity and service work, but also in experimental laboratories. AC (RMS) voltage ranges are 0-.01, .03, .1, .3, 1, 3, 10, 30, 100, and 300 V. Decibel ranges cover -52 DB to +52 DB. An entirely new circuit as compared to the previous model. Employs 1% precision multiplier resistors for maximum accuracy. Handles AC measurements from a low value of one millivolt to a maximum of 300 volts.

HEATHKIT AUDIO WATTMETER KIT

This instrument measures audio power directly at 4, 8, 16, or 600 ohms. Load resistors are built in. Covers 0-5 MW, 50 MW, 500 MW, 5 W, and 50 W full scale. Provides 5 switch-selected DB ranges covering from -10 DB to +30 DB. Large 4½" 200 microampere meter and precision multiplier resistors insure accuracy. Frequency response is ± 1 DB from 10 CPS to 250 kc. Functions from AC power line. Use in the audio laboratory or in home workshop.

MODEL AW-1

\$29⁵⁰

Shpg. Wt. 6 Lbs.

HEATHKIT AUDIO ANALYZER KIT

This multi-function instrument combines an AC VTVM, an audio wattmeter, and an intermodulation analyzer into one case, with combined input and output terminals and built-in high and low frequency oscillators. The VTVM ranges are .01, .03, .1, .3, 1, 3, 10, 30, 100, and 300 volts (RMS). Wattmeter ranges are .15 MW, 1.5 MW, 15 MW, 150 MW, 1.5 W, 15 W, 150 W. IM scales are 1%, 3%, 10%, 30%, and 100%. Provides internal load resistors of 4, 8, 16, or 600 ohms. A valuable instrument for the engineer or serious audiophile.

MODEL AA-1

\$49⁹⁵

Shpg. Wt. 13 Lbs.

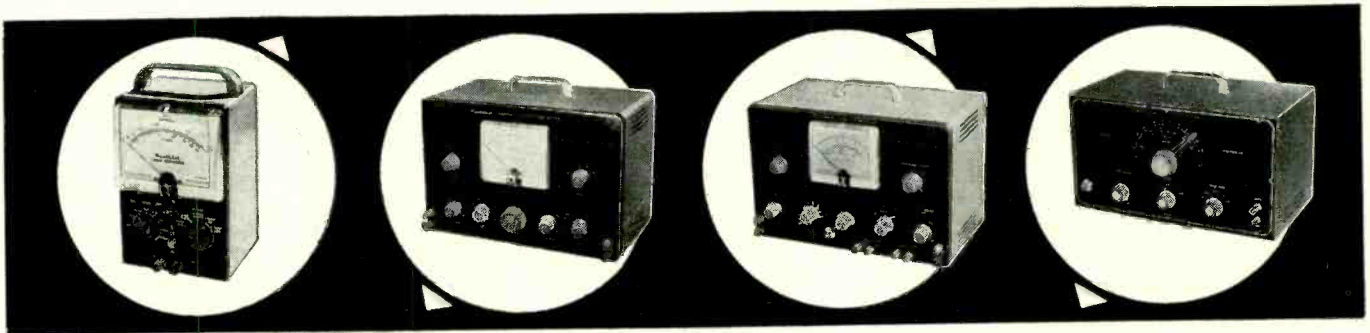

HEATHKIT HARMONIC DISTORTION METER KIT

The HD-1 is equally valuable for the audio engineer or the serious audiophile. Used with a low-distortion audio signal generator, this instrument will measure the harmonic content of various amplifiers under a variety of conditions. Functions between 20 and 20,000 CPS, and reads distortion directly on the panel meter in ranges of 0-1, 3, 10, 30, and 100 percent full scale. Built-in VTVM for initial reference settings and final distortion readings has voltage ranges of 0-1, 3, 10, and 30 volts. 1% precision resistors employed for maximum accuracy. Features voltage regulation and other "extras". Meter calibrated in volts (RMS), percent distortion, and DB.

MODEL HD-1

\$49⁵⁰

Shpg. Wt. 13 Lbs.

HEATHKIT AUDIO OSCILLATOR KIT

Producing both sine waves and square waves, the Model AO-1 covers a frequency range of 20 to 20,000 CPS in three ranges. An extra feature is thermistor regulation of output for flat response through the entire frequency range. AF output is provided at low impedance, and with low distortion. Produces good sine waves, and good, clean square waves with a rise time of only two micro-seconds for checking square wave response of audio amplifiers, etc. Designed especially for the serviceman and high-fidelity enthusiast. A real dollar value in test equipment.

MODEL AO-1

\$24⁵⁰

Shpg. Wt. 10 Lbs.

HEATHKIT



MODEL
AG-9

\$34⁵⁰

Shpg. Wt.
8 Lbs.

- * Less than 0.1% distortion — ideal for hi fi work.
- * Large 4½" meter indicates output.
- * Step-type tuning for maximum convenience.

Audio Generator Kit

This particular audio generator is "made to order" for high fidelity applications. It provides quick and accurate selection of low-distortion signals throughout the audio range. Three rotary selector switches on the front panel allow selection of two significant figures and a multiplier for determining audio frequency. In addition, it incorporates a step-type output attenuator and a continuously variable attenuator. Output is indicated on a large 4½" panel meter calibrated in volts and in db. Attenuator system operates in steps of 10 db, corresponding with the meter calibration. Output ranges are 0-.003, .01, .03, .1, .3, 1, 3, and 10 volts rms. A "load" switch provides for the use of a built-in 600 ohm load or an external load of higher impedance when required. Output and frequency indicators accurate to within ± 5%. Distortion is less than .1 of 1% between 20 cps and 20,000 cps. Total range is 10 cps to 100 kc. New engineering details combine to provide the user with an unusually high degree of operating efficiency. Oscillator frequency selected entirely by the switch method means that accurate resetability is provided. Comparable to units costing many dollars more, and ideal for use in critical high fidelity applications. Shop and compare, and you will appreciate the genuine value of this professional instrument.

HEATHKIT RESISTANCE SUBSTITUTION BOX KIT

The RS-1 contains 36 10% 1-watt resistors ranging from 15 ohms to 10 megohms in standard RETMA values. All values are switch-selected for use in determining desirable resistance values in experimental circuits. Many applications in radio and TV service work.

MODEL RS-1
\$5⁵⁰

Shpg. Wt. 2 Lbs.

HEATHKIT CONDENSER SUBSTITUTION BOX KIT

This kit contains 18 RETMA standard condenser values that can be selected by a rotary switch. Values range from 0.00001 mfd to 0.22 mfd. All capacitors rated at 400 volts or higher. Capacitors are either silver-mica, or plastic molded.

MODEL CS-1
\$5⁵⁰

Shpg. Wt. 2 Lbs.

HEATHKIT AUDIO GENERATOR KIT

The Model AG-8 is a low cost, high performance unit for use in service shop, or home workshop. It covers the frequency range of 20 cps to 1 mc in five ranges. Output is 600 ohms, and overall distortion will be less than .4 of 1% from 100 cps through the audible range. Output is available up to 10 volts, under no load conditions, and output remains constant within ± 1 db from 20 cps to 400 kc. A five-step attenuator provides control of the output. Precision resistors are employed in the frequency determining network.

MODEL AG-8
\$29⁵⁰

Shpg. Wt. 11 Lbs.

HEATHKIT DECADE CONDENSER KIT

Precision, 1% silver-mica capacitors are employed in the Model DC-1 in such a way that a selection of precision capacitor values is provided ranging from 100 mmf (.0001 mfd) to 0.11 mfd (110,000 mmf) in 100 mmf steps. Extremely valuable in all types of design and development work. Switches are ceramic wafer types.

MODEL DC-1
\$16⁵⁰

Shpg. Wt. 3 Lbs.



HEATHKIT DECADE RESISTANCE KIT

The Model DR-1 incorporates twenty 1% precision resistors arranged around five rugged switches so that various combinations of switch positions will provide a total range of 1 ohm to 99,999 ohms in 1-ohm steps. Switches are labeled "units," "tens," "hundreds," "thousands," and "ten thousands." Use it for ohm-meter calibration in bridge circuits as test values in multiplier circuits, etc.

MODEL DR-1
\$19⁵⁰

Shpg. Wt. 4 Lbs.

HEATHKIT VARIABLE VOLTAGE REGULATED POWER SUPPLY KIT

This power supply is regulated for stability, and the amount of DC output available from the power supply can be controlled manually from zero to 500 volts. Will provide regulated output at 450 volts up to 10 ma, or up to 130 ma at 200 volts output. In addition to furnishing B-plus, the power supply provides 6 volts AC at 4 amperes for filaments. Both the B-plus output and the filament output are isolated from ground. Ideal power supply for use in experimental work in the laboratory, the home workshop, or the ham shack. Large 4½" panel meter indicates output voltage or current.

MODEL PS-3
\$35⁵⁰

Shpg. Wt. 17 Lbs.



HEATH COMPANY
A Subsidiary of Daystrom, Inc.
BENTON HARBOR 20, MICH.

BONUS PERFORMANCE . . .
 If a single word had to be selected to describe Heath Company advertising policy, it would be "conservative." By this we mean that the performance specifications and features are not exaggerated, and that the descriptions are accurate. We specify performance on the conservative side so you can be sure of equaling or exceeding our specifications. In almost every instance our kits will do more than we claim. Extra care in construction, and calibration against an accurate standard can extend performance well beyond advertised levels.

HEATHKIT

Signal Generator Kit

- * No calibration required with pre-aligned coils.
- * Modulated or unmodulated RF output.
- * 110 mc to 220 mc frequency coverage.

Here is an RF signal generator for alignment applications in the service shop or the home workshop. Thousands of these units are in use in service shops all over the country. Produces RF signals from 160 kc to 110 mc on fundamentals on five bands. Also covers from 110 mc to 220 mc on calibrated harmonics. RF output is in excess of 100,000 microvolts at low impedance. Output is controllable with a step-type and a continuously variable attenuator. Front panel controls provide selection of either unmodulated RF output or RF modulated at 400 cps. In addition, two to three volts of audio at approximately 400 cps are available at the output terminals for testing AF circuits. Employs a 12AU7 and a 6C4 tube. Built-in power supply uses a selenium rectifier.

One of the most outstanding features about the Model SG-8 is the fact that it can be built in just a few hours, even by one not thoroughly experienced in electronics work. Complete step-by-step instructions combined with large pictorial diagrams assure successful assembly. Pre-aligned coils make calibration from an external source unnecessary.



MODEL SG-8

\$19⁵⁰

Shpg. Wt. 8 Lbs.

HEATHKIT LABORATORY GENERATOR KIT

This laboratory RF signal generator covers from 100 kc to 30 mc on fundamentals in five bands. The output signal may be pure RF, or may be modulated at 400 cycles from 0 to 50%. Provision for external modulation has been made. RF output available up to 100,000 microvolts. Output controlled by a fixed step and a variable attenuator. Output impedance is 50 ohms. Panel meter reads RF output or percentage of modulation. Incorporates voltage regulated B+ supply, double shielding of oscillator circuits, copper plated chassis, and other "extras."

MODEL LG-1

\$48⁹⁵

Shpg. Wt. 16 Lbs.

HEATHKIT TV ALIGNMENT GENERATOR KIT

This improved sweep generator model provides essential stability and flexibility for work on FM, monochrome TV, or color TV sets. Covers 3.6 mc to 220 mc in four bands. Provides usable output even on harmonics. Sweep deviation from 0-42 mc, depending on base frequency. All-electronic sweep circuit eliminates unwieldy mechanical arrangements. Includes built-in crystal marker generator providing output at 4.5 mc and multiples thereof, and variable marker covering 19 to 60 mc on fundamentals and from 57 to 180 mc on harmonics. Effective two-way blanking.

MODEL TS-4A

\$49⁵⁰

Shpg. Wt. 16 Lbs.

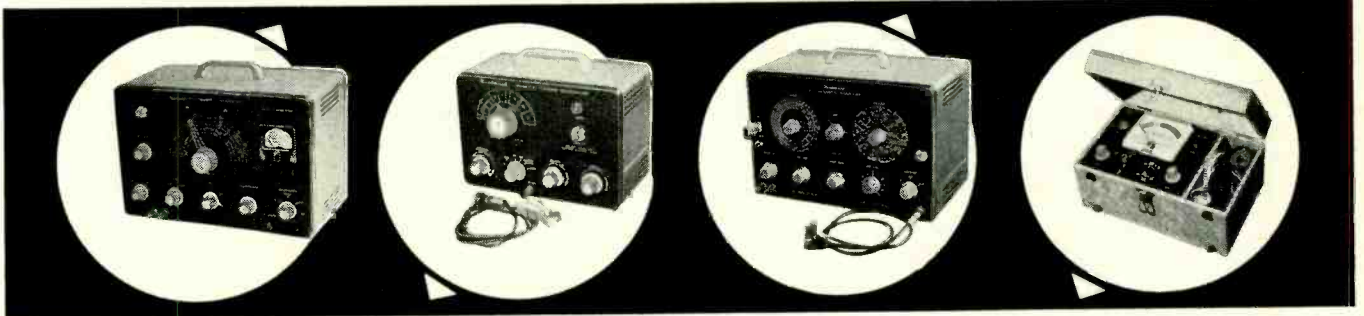

HEATHKIT LINEARITY PATTERN GENERATOR KIT

This instrument supplies information for white dots, cross-hatch pattern, horizontal bar pattern, or vertical bar pattern. It feeds video and sync signals to the set under test, with completely controlled gain, and unusual stability. Covering channels 2 to 13, the LP-2 will produce 5 to 6 vertical bars and 4 to 5 horizontal bars. The dot pattern presentation is a *must* for the setting of color convergence controls in the color TV set. Panel provision made for external sync if desired. Use for adjustment of vertical and horizontal linearity, picture size, aspect ratio, and focus. Power supply is regulated for added stability. Essential in the up-to-date TV service shop.

MODEL LP-2

\$22⁵⁰

Shpg. Wt. 7 Lbs.

HEATHKIT CATHODE RAY TUBE CHECKER KIT

This instrument checks cathode emission, beam current, shorted elements, and leakage between elements in electro-magnetic picture tube types. It eliminates all doubt for the TV serviceman, and even more important, for the customer. Features its own self-contained power supply, transformer operated to furnish normal test voltages for the CRT. Employs spring-loaded switches for maximum operator protection. Large 4 1/2" meter indicates CRT condition on "good-bad" scale. Luggage-type portable case ideal for home service calls. Special "shadowgraph" test permits projection of light spot on screen. Also gives relative check of picture tube screen coating.

MODEL CC-1

\$22⁵⁰

Shpg. Wt. 10 Lbs.

HEATHKIT

Tube Checker Kit



MODEL
TC-2

\$29⁵⁰

Shpg. Wt.
12 lbs.

- * Attractive counter-style cabinet.
- * Wiring-harness simplifies assembly.
- * Large 4½" meter with two-color "good-bad" scale.
- * Separate tube element switches prevent obsolescence.

This fine piece of test gear checks tubes for quality, emission, shorted elements, open elements, and filament continuity. Will test all tube types normally encountered in radio and TV service work. Sockets provided for 4, 5, 6, and 7-pin large, rectangular, and miniature types, octal and loctal types, the Hytron 9-pin miniatures, and pilot lamps. Condition of tubes indicated on a large 4½" meter with multi-color "good-bad" scale. An illuminated roll chart is built right in, providing test data for various tube types. This tester provides switch selection of 14 different filament voltage values from 0.75 volts to 117 volts. Individual switches control each tube element. Close tolerance resistors employed in critical test circuits for maximum accuracy. A professional instrument both in appearance and performance.

The Model TC-2 is very simple to build, even for a beginner. It employs a color-coded cable harness for neat, professional under-chassis wiring. Comes with attractive counter style cabinet, and portable cabinet is available separately. At this price, even the part-time serviceman can afford his own tube checker for maximum efficiency in service work.

HEATHKIT TV PICTURE TUBE TEST ADAPTER

Designed especially for use with the Model TC-2 tube checker. Use it to test TV picture tubes for emission, shorts, etc. Consists of 12-pin TV tube socket, 4 ft. cable, octal connector, and necessary technical data. Not a kit.



MODEL 355

\$4⁵⁰

Shpg. Wt.
1 lb.

HEATHKIT PORTABLE TUBE CHECKER KIT

This portable tube checker is identical, electrically, with the Model TC-2. However, it is housed in an attractive and practical carrying case, finished in proxylin impregnated material. The cover is detachable, and the hardware is brass plated. This rugged unit is ideal for home service calls or any portable application.



MODEL
TC-2P

\$34⁵⁰ Shpg. Wt.
15 lbs.

HEATHKIT VISUAL-AURAL SIGNAL TRACER KIT

Although designed primarily for radio receiver work, this valuable instrument finds extensive application in FM and TV servicing as well. Features a high-gain channel with demodulator probe, and a low-gain channel with audio probe. Will trace signals in all sections of a radio receiver and in many sections of a FM set or TV receiver. Uses built-in speaker and electron beam eye tube for indication. Also features built-in wattmeter and a noise locator circuit. Provision for patching speaker and/or output transformer into external set.

MODEL T-3

\$23⁵⁰

Shpg. Wt. 9 lbs.

HEATHKIT DIRECT READING CAPACITY METER KIT

Operation of this instrument is simplicity itself. One has only to connect a capacitor to the terminals, select the proper range, and read the capacity value directly on the large 4½" meter calibrated in mmf and mfd.

Ranges are 0 to 100 mmf, 1,000 mmf, 0.01 mfd, and 0.1 mfd full scale. Precision calibrating capacitors supplied. Not susceptible to hand capacity effects. Residual capacity less than 1 mmf. Especially valuable in production line checking, or in quality control.

MODEL CM-1

\$29⁵⁰

Shpg. Wt.
7 lbs.



HEATHKIT CONDENSER CHECKER KIT

The Model C-3 consists of an AC powered bridge for both capacitive and resistive measurements. Bridge balance is indicated on electron beam eye tube, and capacity or resistance value is indicated on front panel calibrations. Measures capacity in four ranges from .00001 mfd to .005 mfd, .001 mfd to .5 mfd, .1 mfd to 50 mfd, and 20 mfd to 1000 mfd. Measures resistance in two ranges, from 100 ohms to 50,000 ohms, and from 10,000 ohms to 5 megohms. Selection of five different polarizing voltages for checking capacitors, from 25 volts DC to 450 volts DC. Checks paper, mica, ceramic, and electrolytic capacitors. Indicates power factor of electrolytic condensers.

MODEL C-3

\$19⁵⁰

Shpg. Wt. 7 lbs.



HEATH COMPANY

A Subsidiary of Daystrom, Inc.

BENTON HARBOR 20, MICH.

PIONEER DESIGN . . .

New and unique approaches to instrument and equipment designs are a Heath Company tradition. We concentrate all our development efforts on kit projects, since this is our prime activity—and not just a sideline. This logically results in more efficient, more reliable circuit designs—and you benefit from this constant engineering progress. Buying from the undisputed leader in the electronic kit field assures you of completely modern equipment, with outstanding advanced design features.

HEATHKIT

Impedance Bridge Kit

- * 1/2% precision resistors and silver-mica capacitors.
- * Battery-type tubes, no warm-up required.
- * Built-in phase shift generator and amplifier.

The Model IB-2 is a completely self-contained unit. It has a built-in power supply, a built-in 1000 cycle generator, and a built-in vacuum tube detector. Provision has been made on the panel for connection to an external detector, an external signal generator, or an external power supply. A 100-0-100 micro-ampere meter on the front panel provides for null indications. Measures resistance from 0.1 ohm to 10 megohms, capacitance from 10 mmf to 100 mfd, inductance from 10 mh to 100 h, dissipation factor (D) from 0.002 to 1, and storage factor (Q) from 0.1 to 1000. 1/2 of 1% decade resistors employed for maximum accuracy. Typical accuracy figures are: resistance, $\pm 3T$; capacitance $\pm 3\%$; inductance, $\pm 10\%$; dissipation factor, $\pm 20\%$; storage factor, $\pm 20\%$. Employs a Wheatstone bridge, a Capacity Comparison bridge, a Maxwell bridge, and a Hay bridge. Special two-section CRL dial provides maximum convenience in operation. Use the Model IB-2 for determining values of unmarked components, checking production or design samples, etc. A real professional instrument.



MODEL
IB-2

\$59⁵⁰ Shpg. Wt.
12 lbs.

HEATHKIT "Q" METER KIT

The Q Meter permits measurement of inductance from 1 microhenry to 10 millihenries, "W" on a scale calibrated up to 250 full scale, with multiplying factors of 1 or 2, and capacitance from 40 mmf to 450 mmf, ± 3 mmf. Built-in variable oscillator permits testing components from 150 kc to 18 mc. Large 4 1/2" panel-mounted meter is features. Very handy for checking peaking coils, chokes, etc. Use to determine values of unknown condensers, both variable and fixed. Compile data for coil winding purposes, or measure RF resistance. Distributed capacity, and Q of coils.

MODEL QM-1

\$44⁵⁰

Shpg. Wt. 14 lbs.

HEATHKIT ISOLATION TRANSFORMER KIT

This device isolates equipment under test from the power line. It is rated at 100 volt-amperes continuously, or 200 volt-amperes intermittently. AC-DC sets may be plugged directly into the IT-1 without the chassis becoming "hot." Additionally, since the IT-1 is fused, it is ideal for use as a buffer between the power line and a questionable receiver, or a new piece of equipment. Protects main fuses. Features voltage control, allowing control of the output from 90 volts to 130 volts. Panel meter monitors output voltage. A very handy device at an extremely low price.

MODEL IT-1

\$16⁵⁰

Shpg. Wt. 9 lbs.

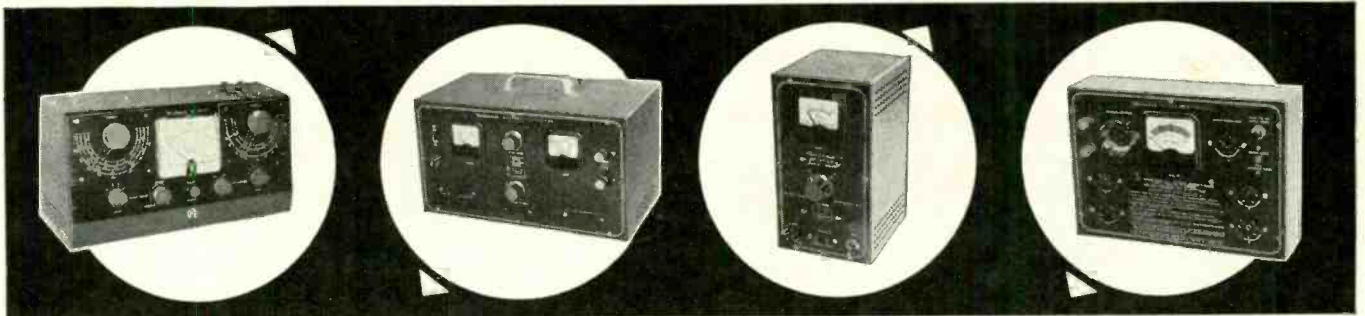

HEATHKIT 6-12 VOLT BATTERY ELIMINATOR KIT

This completely modern battery eliminator will supply DC output in two ranges for both 6-volt and 12-volt automobile radios. The output is variable for each range, so that operating voltage can be raised or lowered to determine how the receiver functions under adverse conditions. Range is 0-8 volts DC or 0-16 volts DC. Will supply up to 15 amperes on the 6-volt range, or up to 7 amperes on the 12-volt range. Two 10,000 microfarad output filter capacitors insure smooth DC output. Two separate panel meters indicate output voltage or output current. Makes it possible to test automobile radios inside at the workbench. Will also double as a battery charger.

MODEL BE-4

\$31⁵⁰

Shpg. Wt. 17 lbs.

HEATHKIT 6-VOLT VIBRATOR TESTER KIT

This instrument functions very much like a tube checker, to test auto radio vibrators. Vibrator condition is indicated on a simple "good-bad" scale. Tests for proper starting and overall quality of operation, of both interrupter and self-rectifier types of 6-volt vibrators. The model VT-1 is designed to operate from any battery eliminator capable of delivering continuously variable output from 4 to 6 volts DC at 4 amperes or more. It is an ideal companion unit for the Heathkit Model BE-4 battery eliminator. The construction book for the VT-1 contains vibrator test chart for popular 6-volt vibrator types. A real time saver!

MODEL VT-1

\$14⁵⁰

Shpg. Wt. 6 lbs.

HEATHKIT DX-100 PHONE AND CW



**MODEL
DX-100**
Shpg. Wt.
107 Lbs.

\$189⁵⁰

Shipped motor freight unless otherwise specified. \$50.00 deposit required on c.o.d. orders.

- * Phone or CW on 160, 80, 40, 20, 15, 11 and 10 meters.
- * Built-in VFO, modulator, and power supplies.
- * High quality components used throughout for reliable performance.
- * Features 5-point TVI suppression.

Transmitter Kit

The Heathkit DX-100 transmitter is in a class by itself in that it offers features far beyond those normally received at this price level. It takes very little listening on the bands to discover how many of these transmitters are in operation today. A truly amazing piece of amateur gear. The DX-100 features a built-in VFO and a built-in modulator. It is TVI suppressed, and uses pi network interstage coupling and output coupling. Will match antenna impedances from approximately 50 to 600 ohms. Extensive shielding is employed, and all incoming and outgoing circuits are filtered. The cabinet features interlocking seams for simplified assembly and minimum RF radiation outside of the cabinet. Provides a clean strong signal on either phone or CW, with RF output in excess of 100 watts on phone, and 120 watts on CW. Completely bandswitching from 160 through 10 meters. A pair of 1625 tubes are used in push-pull for the modulator, and the final consists of a pair of 6146 tubes in parallel. The VFO dial and meter face are illuminated, and all front panel controls are located for maximum convenience. Panel meter reads driver plate I, final grid I, final plate I, final plate voltage, and modulator current. The chassis is constructed of heavy #16 gauge copper-plated steel. Other high-quality components include potted transformers, ceramic switch and variable capacitor insulation, silver-plated or solid-silver switch terminals, etc. All coils are pre-wound, and the main wiring cable is pre-harnessed. The kit can be built by a beginner from the comprehensive step-by-step instructions supplied. It is a proven, trouble-free rig, that will insure many hours of "on-the-air" enjoyment in your ham shack.

HEATHKIT COMMUNICATIONS TYPE ALL BAND RECEIVER KIT

This receiver covers 550 kc to 30 mc in four bands, and is ideal for the short-wave listener or beginning amateur. It provides good sensitivity and selectivity, combined with good image rejection. Amateur bands clearly marked on illuminated dial scale. Employs transformer type power supply—electrical bandspread—antenna trimmer—separate RF and AF gain controls—noise limiter—headphone jacks—

MODEL AR-3
\$30⁷⁵

INCLUDING NEW
EXCISE TAX*
(Less Cabinet)
Shpg. Wt. 12 Lbs.

VFO for CW reception.
CABINET: Fabric covered cabinet with aluminum panel as shown. Part 91-15A. Shipping weight 5 Lbs. \$4.95†

HEATHKIT VFO KIT

You can go VFO for less than you might expect. Here is a variable frequency oscillator that covers 160, 80, 40, 20, 15, 11, and 10 meters with three basic oscillator frequencies, that sells for less than \$20. Provides better than 10 volt average RF output on fundamentals. Plenty of drive for most modern transmitters. Requires a power source of only 250 VDC at 15 to 20 ma. and 6.3 VAC at 0.45A. Incorporates a regulator tube for stability. Illuminated frequency dial reads frequency directly on the band being employed. Temperature-compensated capacitors offset coil heating.

MODEL VF-1

\$19⁵⁰

Shpg. Wt. 7 Lbs.

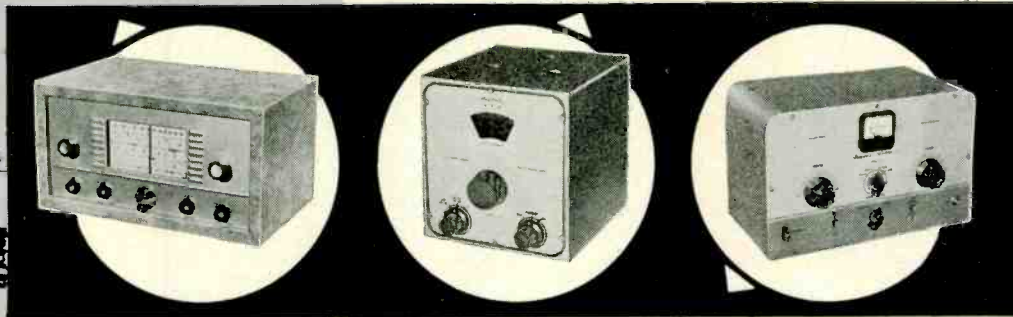

EASY ON THE BUDGET!

You can buy Heathkits on an easy time-payment plan that provides a full year to pay. Write for complete details and special order blank.

HEATHKIT CW TRANSMITTER KIT

This is the original low-priced Heathkit CW transmitter. Its reliable performance has been proven time and time again on the CW bands. Designed for crystal control, the Model AT-1 covers 80, 40, 20, 15, 11, and 10 meters. May be excited from external VFO. Plate power input up to 30 watts. Power supply built in. Panel meter indicates grid current or plate current for final. Incorporates pre-wound coils, copper-plated chassis, built-in line filter, profuse shielding, and top-quality parts throughout. Crystal socket and key jack on front panel. Built-in key-click filter, and single-knob bandswitching. 52-ohm coaxial output. Uses 6AG7 oscillator-multiplier, 6L6 power amplifier-doubler, and 5U4G rectifier.

MODEL AT-1

\$29⁵⁰

Shpg. Wt. 15 Lbs.



HEATH COMPANY
A Subsidiary of Daystrom, Inc.
BENTON HARBOR 20, MICH.

DOLLAR-SAVING ECONOMY . . .
 There would be no particular achievement in selling inexpensive merchandise at a low price—although it is being done every day. However, there is something to crow about when, through tremendous purchasing power and factory-to-you distribution, Heath Company can offer top-quality equipment, using name-brand components, at such low prices. This is real economy, as opposed to the so-called "bargains". Needless to say, there is a big difference.

**HEATHKIT PHONE AND CW
 Transmitter Kit**

- * 6146 final amplifier for full 65-watt plate power input.
- * Phone and CW operation on 80, 40, 20, 15, 11, and 10 meters. Pi network output coupling.
- * Switch selection of three crystals — provision for external VFO excitation.

The DX-35 features a 6146 final amplifier to provide 65 watts plate power input on CW, with controlled carrier modulation peaks up to 50 watts on phone. In addition, it is a most attractive transmitter. Modulator and power supplies are built-in, and the rig covers 80, 40, 20, 15, 11, and 10 meters with a single band-change switch. Pi network output coupling provided for matching various antenna impedances. A 12BY7 buffer stage provided ahead of the final amplifier for plenty of drive on all bands. 12BY7 oscillator and 12AU7 modulator. Provision for switch selection of three different crystals. Crystals reached through access door at rear. Front panel controls marked "off—CW—stand-by—phone", "final tuning", "antenna coupling", "drive level control", and "band change switch". Panel meter indicates final grid current or final plate current. A perfect low-power transmitter both for the novice, and for the more experienced operator. A remarkable power package for the price. Incidentally, the price includes tubes, and all other components necessary for assembly. As with all Heathkits, comprehensive instruction manual assures successful assembly.



MODEL DX-35
\$56⁹⁵ Shpg. Wt. 24 Lbs.

HEATHKIT ANTENNA IMPEDANCE METER KIT

This instrument employs a 100 microampere panel meter and covers the impedance range of 0-600 ohms for RF tests. Functions up to 150 mc. Used in conjunction with signal source, such as the Heathkit Model GD-1B grid dip meter, the Model AM-1 will determine antenna resistance and resonance, match transmission lines for minimum standing wave ratio, determine receiver input impedance, etc. Will also double as a phone monitor. A very valuable device for many uses in the ham shack.

MODEL AM-1
\$14⁵⁰
 Shpg. Wt. 2 Lbs.

HEATHKIT "Q" MULTIPLIER KIT

The QF-1 functions with any receiver with an IF frequency between 450 and 460 kc that is not AC-DC type. Operates from the receiver power supply, requiring only 6.3 VAC at 300 ma. and 150 to 250 VDC at 2 ma. Simple to connect with cable and plugs supplied. Provides additional selectivity for separating two signals, or will reject one signal and eliminate heterodyne. A big help on crowded bands. Provides an effective Q of approximately 4,000 for sharp "peak" or "null". Tunes to any signal within the IF bandpass of the receiver, without changing main receiver tuning dial.

MODEL QF-1
\$9⁹⁵
 Shpg. Wt. 3 Lbs.

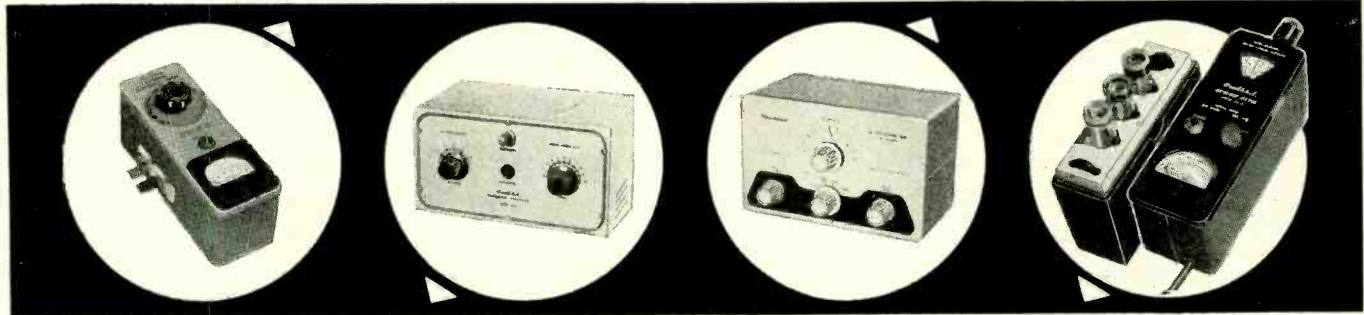

HEATHKIT ANTENNA COUPLER KIT

This device is designed to match the Model AT-1 transmitter to a long-wire antenna. In addition to impedance matching, this unit incorporates an L-type filter which attenuates signals above 36 megacycles, thereby reducing TVI. Designed for 52 ohm coaxial input. Handles power up to 75 watts, 10 through 80 meters. Uses a tapped inductor and variable capacitor. Neon RF indicator on front panel. Copper-plated chassis—high quality components throughout—simple to build. Eliminates waste of valuable communications power due to improper matching. A "natural" for all AT-1 transmitter owners.

MODEL AC-1
\$14⁵⁰
 Shpg. Wt. 4 Lbs.

HEATHKIT GRID DIP METER KIT

The grid dip meter was originally designed for the ham shack. However, its use has been extended into the service shop and laboratory. Continuous frequency coverage from 2 mc to 250 mc with pre-wound coils. 500 microampere panel meter employed for indication. Use for locating parasitics, neutralizing, determining RF circuit resonant frequencies, etc. Coils are included with kit, as is a coil rack. Front panel controls include sensitivity control for meter, and phone jack for listening to zero-beat. Will also double as an absorption-type wavemeter.

MODEL GD-1B
\$19⁹⁵
 Shpg. Wt. 4 Lbs.

HEATHKIT BROADCAST BAND



MODEL BR-2
(Less Cabinet)
Shpg. Wt. 10 Lbs.

\$19²⁵

INCLUDING NEW
EXCISE TAX*

ATTENTION BEGINNERS . . .

This kit is an ideal "first project" if you have never built a Heathkit before. A good chance to "learn by doing."

- * Miniature tubes and high-gain IF transformer.
- * 5½-inch PM speaker.
- * Rod-type built-in antenna. Good sensitivity and selectivity.
- * Provision for phono jack.
- * Transformer-operated power supply.

Receiver Kit

You need no previous experience in electronics to build this table-model radio. The Model BR-2 receiver covers 550 kc to 1620 kc and features good sensitivity and selectivity over the entire band. A 5½" PM speaker is employed, along with high gain miniature tubes and a new rod-type built-in antenna. Provision has been made in the design of this receiver for its use as a phonograph amplifier. The phono jack is located on the back chassis apron. A transformer operated power supply is featured for safety of operation, as opposed to the usual AC-DC supply commonly found in "economy radio kits." Don't let the low Heathkit price deceive you. This is the kind of set you will want to show off to your family and friends after you have finished building it.

Construction of this radio kit is very simple. Giant size pictorial diagrams and detailed step-by-step instructions assure your success. The construction manual also includes an explanation of basic receiver circuit theory so you can "learn by doing" as the receiver is built. The manual even provides information on resistor and capacitor color codes, soldering techniques, use of tools, etc. If you have ever had the urge to build your own radio receiver, the outstanding features of this popular Heathkit deserve your attention.

CABINET: Proxylon impregnated fabric covered plywood cabinet available for the BR-2 receiver as shown. Complete with aluminum panel, reinforced speaker grill, and protective rubber feet. Shipping weight 5 lbs., part No. 91-9A.....\$4.95*

HEATHKIT PROFESSIONAL RADIATION COUNTER KIT

This sensitive and reliable instrument has already found extensive application in prospecting, and also in medical and industrial laboratories. It offers outstanding performance at a reasonable price. Front-panel meter indicates radiation level, and oral indication produced by panel-mounted speaker. Meter ranges are 0-100, 600, 6,000 and 60,000 counts per minute, and 0-.02, .1, 1 and 10 milliroentgens per hour. The probe, with expansion cord, employs type 6306 bismuth counter tube, sensitive to both beta and gamma radiation. It is simple to build, even for a beginner.

MODEL RC-1

\$79⁹⁵

Shpg. Wt. 8 Lbs.

HEATHKIT CRYSTAL RECEIVER KIT

The crystal radio of Dad's day is back again, but with big improvements! The Model CR-1 employs a sealed germanium diode, eliminating the critical "cat's whisker" adjustment. It is housed in a compact plastic box, and features two Hi-Q tank circuits, employing ferrite core coils and variable air tuning capacitors. The CR-1 covers the standard broadcast band from 540 kc to 1600 kc, and no external power is required for operation. Could prove valuable for emergency signal reception. This easy-to-build kit is a real "learn by doing" experience for the beginner, and makes an interesting project for all ages.

MODEL CR-1

\$87⁵

INCLUDING NEW
EXCISE TAX*
Shpg. Wt. 3 Lbs.



- * Amazing new circuit for high efficiency.

- * Compact, portable and rugged.
- * Stable circuit requires only one 67½ volt "B" battery and two 1½ volt "A" batteries.

HEATHKIT ENLARGER TIMER KIT

The Model ET-1 is an easy-to-build device for use by amateur or professional photographers in controlling the timing cycle of an enlarger. It covers the range of 0 to 1 minute with a continuously variable, clearly calibrated scale. The timing period is pre-set, and the timing cycle is initiated by depressing the spring-return switch to the "print" position. Front panel provision is made for plugging in the enlarger and a safelight. The safelight is automatically turned "on" when the enlarger is "off". Handles up to 350 watts. The timing cycle is controlled electronically for maximum accuracy and reliability. Very simple to build in only one evening, even by a beginner.

MODEL ET-1

\$11⁵⁰

Shpg. Wt. 3 Lbs.



HEATH COMPANY

A Subsidiary of Daystrom, Inc.

BENTON HARBOR 20, MICH.

HEATHKIT HIGH FIDELITY

Preamplifier Kit

COMPREHENSIVE INSTRUCTIONS . . .

The step-by-step assembly instructions provided with each Heathkit are the finest available anywhere. Each manual begins at the beginning, and assumes no previous training or experience on the part of the kit builder. This means that our kits can be built successfully by anyone who can follow instructions. As a matter of fact, new manuals are tested by having the kit built by someone in our office who has had no previous experience in electronics. This is your guarantee of complete and thorough instruction material.

- * 5 switch-selected inputs, each with its own level control.
- * Equalization for LP, RIAA, AES, and Early 78's.
- * Separate bass and treble tone controls, and special hum control.
- * Clean, modern lines and satin-gold enamel finish.

Literally thousands of these preamplifiers are in use today, because the kit meets or exceeds specifications for the most rigorous high-fidelity applications, and will do justice to the finest available program sources. Provides a total of 5 inputs, each with individual level controls (three high-level and two low-level). Frequency response is within 1 DB from 25 CPS to 30,000 CPS, or within 1½ DB from 15 CPS to 35,000 CPS. Hum and noise are extremely low, with special balance control for absolute minimum hum level. Tone control provides 18 DB boost and 12 DB cut at 50 CPS, and 15 DB boost and 20 DB cut at 15,000 CPS. Cabinet measures only 12-9/16" W. x 3¾" H. x 4¾" D, and it is finished in beautiful satin-gold enamel. 4-position turnover and 4 position roll-off controls provide "LP," "RIAA," "AES," and "early 78" equalization, and 8, 12, 16, and 1 flat position for roll-off. Derives operating power from the main amplifier, requiring only 6.3 VAC at 1 ampere and 300 VDC at 10 MA. Easy to construct from step-by-step instructions and pictorial diagrams provided.

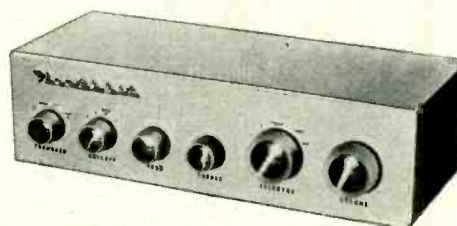

MODEL WA-P2 (With Cabinet) Shpg. Wt. 7 Lbs.

\$19⁷⁵

HEATHKIT HIGH FIDELITY FM TUNER KIT

- * Illuminated slide-rule dial covers 88 to 108 MC.
- * Modern circuit emphasizes sensitivity and stability.
- * Housed in attractive satin-gold cabinet to match WA-P2 and BC-1.

This amazing new FM tuner can provide you with real high-fidelity performance at an unbelievably low price level. Covering 88 to 108 MC, the modern circuit features a stabilized, temperature-compensated, oscillator, A.G.C., broadbanded

IF circuits, and better than 10 UV sensitivity for 20 DB of quieting. A high gain, cascaded, RF amplifier is used ahead of the mixer to increase overall gain and reduce oscillator leakage. It employs a ratio detector for high efficiency without sacrifice in high-fidelity performance. IF and ratio transformers are pre-aligned, as is the front end tuning unit. This means the kit can be constructed by a beginner, without elaborate test and alignment equipment. The FM-3A is designed to match the WA-P2 preamplifier and the BC-1 AM MODEL FM-3A tuner. An illuminated slide-rule dial is employed for frequency indication. Step-by-step instructions and large pictorial diagrams assure success.

\$26⁹⁵
INCLUDING NEW EXCISE TAX*
(With Cabinet) Shpg. Wt. 7 Lbs.



HEATHKIT BROADBAND AM TUNER KIT

This AM tuner has been designed especially for high-fidelity applications. It incorporates a low-distortion detector, a broadband IF, and other features essential to usefulness in high-fidelity. Special voltage-doubler detector employs crystal diodes for low distortion. Sensitivity and selectivity are excellent. Audio response is ± 1 DB from 20 CPS to 2 kc, with 5 DB of pre-emphasis at 10 kc to compensate for station roll-off. Covers the standard broadcast band from 550 to 1600 kc. Incorporates a 10 kc whistle-filter and provides a 6 DB signal-to-noise ratio at 2.5 UV. RF and IF coils are pre-aligned, and power supply is built-in. Incorporates AVC, two outputs, and two antenna inputs.

MODEL BC-1
\$26⁹⁵
INCLUDING NEW EXCISE TAX*
(With Cabinet) Shpg. Wt. 8 Lbs.

HEATHKIT ELECTRONIC CROSS-OVER KIT

This unusual device functions to separate low frequencies and high frequencies so that they may be fed to separate amplifiers and to separate speakers. This eliminates the need for conventional cross-over circuits, since the Model XO-1 does the complete job electronically. Cross-over frequencies of 100, 200, 400, 700, 1,200, 2,000 and 35 00 CPS are selectable with front panel controls on the XO-1, and a separate level control is provided for each channel. Minimizes inter-modulation distortion problems. Handles unlimited power, since frequency division is accomplished ahead of the power stage. Attenuation is 12 DB per octave, with sharp "knee" at cut-off frequency.

MODEL XO-1
\$18⁹⁵
Shpg. Wt. 6 Lbs.

HEATHKIT ADVANCED-DESIGN



MODEL W-5M
Shpg. Wt. 31 Lbs.
Express Only

\$59⁷⁵

MODEL W-5

Consists of Model W-5M plus Model WA-P2 pre-amplifier.

Shpg. Wt. 38 Lbs.
Express only... \$79.50

- * Full 25 watt output with KT-66 output tubes.
- * All connectors brought out to front chassis apron.
- * Protective cover over all above-chassis components.

HIGH FIDELITY

Amplifier Kit

This 25 watt unit is our finest high-fidelity amplifier. Using a special design peerless output transformer, and KT-66 output tubes by Genalex, the Model W-5M provides performance characteristics unsurpassed at this price level. Frequency response is ± 1 DB from 5 to 160,000 CPS at 1 watt. Harmonic distortion is less than 1% at 25 watts and 1M distortion is less than 1% at 20 watts (60 and 3,000 CPS, 4 to 1). Hum and noise are 99 DB below 25 watts. Damping factor is 40 to 1. Input voltage for 5 watts output is 1 volt. Tubes employed are a pair of 12AU7's, a pair of KT-66's and a 5R4GY rectifier. Measures 13-3/32" W. x 8 1/2" D. x 8 1/4" H. Output impedance is 4, 8, or 16 ohms. Featured, also, is the "tweeter saver" which suppresses high frequency oscillation, and a new type balancing circuit requiring only a voltmeter for indication. This balance is easier to adjust, and results in a closer "dynamic" balance between output tubes. The Model W-5M provides improved phase shift characteristics, reduced IM and harmonic distortion, and improved frequency response. Conservatively rated high-quality components are used throughout to insure years of trouble-free operation. No technical background or training is required for assembly. Step-by-step instructions are provided for every stage of construction, and large pictorial diagrams illustrate exactly where each wire and component is to be placed. An amplifier for music lovers who can appreciate subtle differences in performance. Just ask the audiophile who owns one!

HEATHKIT DUAL-CHASSIS—WILLIAMSON TYPE HIGH FIDELITY AMPLIFIER KIT

This 20-watt high-fidelity amplifier employs the famous Acro-sound Model TO-300 "ultra-linear" output transformer and uses 5881 output tubes. The power supply is built on a separate chassis, and the two chassis are inter-connected with a power cable. This provides additional flexibility in mounting. Frequency response is ± 1 DB from 6 CPS to 150 kc at 1 watt. Harmonic distortion is only 1% at 21 watts, and 1M distortion is only 1.3% at 20 watts. (60 and 3,000 CPS). Output impedance is 4, 8, or 16 ohms. Hum and noise are 88 DB below 20 watts. A very popular high-fidelity unit employing top-quality components throughout.

MODEL W-3M: Shpg. Wt. 29 Lbs. Express only... \$49.75

MODEL W-3: Consists of Model W-3M plus Model WA-P2 pre-amplifier. Shpg. Wt. 37 Lbs. Express only... \$69.50

HEATHKIT SINGLE CHASSIS—WILLIAMSON TYPE HIGH FIDELITY AMPLIFIER KIT

The 20-watt Model W-4AM Williamson type amplifier is a tremendous high-fidelity bargain. Combining the power supply and main amplifier on one chassis, and using a special-design output transformer by Chicago Standard brings you savings without a sacrifice in quality. Employing 5881 output tubes, the frequency response of the W-4AM is ± 1 DB from 10 CPS to 100 kc at 1 watt. Harmonic distortion is only 1.5% at 20 watts. Output impedance is 4, 8, or 16 ohms. Hum and noise are 95 DB below 20 watts.

MODEL W-4AM: Shpg. Wt. 28 Lbs. Express only... \$39.75

MODEL W-4A: Consists of Model W-4AM plus Model WA-P2 pre-amplifier. Shpg. Wt. 35 Lbs. Express only... \$59.50

HEATHKIT 7-WATT AMPLIFIER KIT

This amplifier is more limited in power than other Heathkit models, but it still qualifies as a high-fidelity unit, and its performance definitely exceeds that of many so-called "high-fidelity" phonograph amplifiers. Using a tapped-screen output transformer of new design, the Model A-7D provides a frequency response of $\pm 1 1/2$ DB from 20 to 20,000 CPS. Total distortion is held to a surprisingly low level. Output stage is push pull, and separate bass and treble tone controls are provided. Shpg. Wt. 10 Lbs.

MODEL A-7E: Similar to the A-7D, except that a 12SL7 tube has been added for pre-amplification. Two inputs, RIAA compensation, and extra gain.

MODEL A-7D
\$18⁶⁵

INCLUDING NEW EXCISE TAX*

\$20.35*

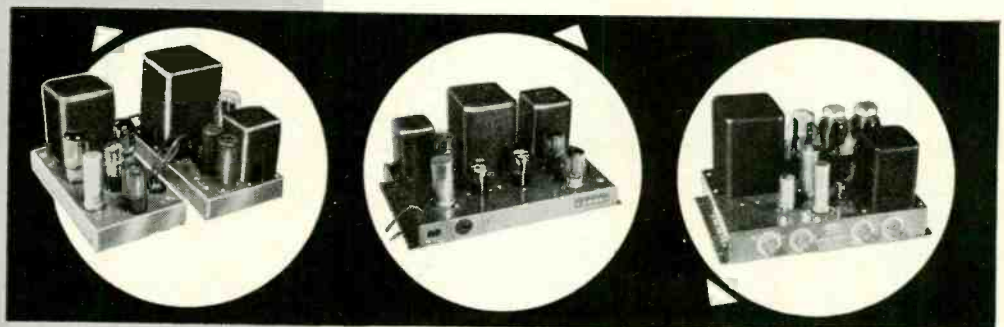

HEATHKIT 20-WATT HIGH FIDELITY AMPLIFIER KIT

This high-fidelity amplifier features full 20-watt output using push pull 6L6 tubes. Built-in preamplifier provides 4 separate inputs, selected by a panel-mounted switch. It has separate bass and treble tone controls, each offering 15 DB boost and cut. Output transformer is tapped at 4, 8, 16, and 500 ohms. Designed primarily for home installations, but also used extensively for public address applications. True high-fidelity performance with frequency response of ± 1 DB from 20 CPS to 20,000 CPS. Total harmonic distortion only 1% (at 3 DB below rated output).

MODEL A-9B

\$35⁵⁰

Shpg. Wt. 23 Lbs.



HEATH COMPANY

A Subsidiary of Daystrom, Inc.

BENTON HARBOR 20, MICH.

HEATHKIT HIGH FIDELITY

Range Extending SPEAKER SYSTEM KIT

All prices marked with a † include a 10% federal excise tax that now applies to receivers, tuners and some amplifiers, even though they may be in kit form. Since the tax is in effect as of July 5, 1956, we have no choice but to reflect it in our kit prices. This note is just to let you know we are not increasing our prices on some kits, but merely including this new tax in them.

Thank you,
HEATH COMPANY

- * High quality speakers of special design — 15" woofer and compression-type super-tweeter.
- * Easy-to-assemble cabinet of furniture-grade plywood.
- * Attractively styled to fit into any living room. Matches Model SS-1.

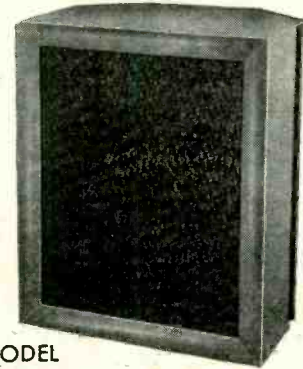

MODEL
SS-1B

\$99⁹⁵

Shpg. Wt. 80 Lbs.

This range extending unit is designed especially for use with the Model SS-1 speaker system. It consists of a 15" woofer, providing output between 35 and 600 CPS, and a compression-type super-tweeter that provides output between 4,000 and 16,000 CPS. Cross-over frequencies are 600, 1,600, and 4,000 CPS. The SS-1 provides the mid-range, and the SS-1B extends the coverage at both ends of the spectrum. Together, the two speaker systems provide output from 35 to 16,000 CPS within ± 5 DB. This easy-to-assemble speaker enclosure kit is made of top-quality furniture-grade plywood. All parts are pre-cut and pre-drilled, ready for assembly and the finish of your choice. Complete step-by-step instructions are provided for quick assembly by one not necessarily experienced in woodworking. Coils and capacitors for proper cross-over network are included, as is a balance control for super-tweeter output level. The SS-1 and SS-1B can provide you with unbelievably rich audio reproduction, and yet these units are priced reasonably. The SS-1B measures 29" H. x 23" W. x 17½" D. The speakers are both special-design Jensens, and the power rating is 35 watts. Impedance is 16 ohms.

HEATHKIT HIGH FIDELITY SPEAKER SYSTEM KIT



MODEL
SS-1

\$39⁹⁵

Shpg. Wt. 30 Lbs.

This speaker system is a fine reproducer in its own right, covering 50 to 12,000 CPS within ± 5 DB. However, the story does not end there. Should you desire to expand the system later, the SS-1 is designed to work with the SS-1B range extending unit — providing additional frequency coverage at both ends of the spectrum. It can fulfill your present needs, and still provide for the future. The SS-1 uses two Jensen speakers; an 8" midrange-woofer, and a compression-type tweeter. Cross-over frequency is 1,600 CPS, and the system is rated at 25 watts. Nominal impedance is 16 ohms. The cabinet is a ducted-port bass-reflex type. Attractively styled, the Model SS-1 features a broad "picture-frame" molding that will blend with any room decorating scheme. Pre-cut and pre-drilled wood parts are of furniture grade plywood. The kit is easy-to-build, and all component parts are included, along with complete step-by-step instructions for assembly. Can be built in just one evening, and will provide you with many years of listening enjoyment thereafter.

- * Special design ducted-port, bass-reflex enclosure.
- * Two separate speakers for high and low frequencies.
- * Kit includes all parts and complete instructions for assembly.

HEATH COMPANY A Subsidiary of Daystrom, Inc. **BENTON HARBOR 20, MICH.**

ORDER BLANK

NOTE: All prices subject to change without notice.

Enclosed find () check () money order for _____
Please ship C.O.D. () postage enclosed for _____ pounds.

On Express orders do not include transportation charges — they will be collected by the express agency at time of delivery.

ON PARCEL POST ORDERS include postage for weight shown. ORDERS FROM CANADA and APO'S must include full remittance.

Name _____

Address _____

City & Zone _____ State _____

(PLEASE PRINT)

SHIP VIA

Parcel Post

Express

Freight

Best Way

QUANTITY	ITEM	MODEL NO.	PRICE

New resonant-frequency nomogram permits greater accuracy

By JOSEPH F. SODARO

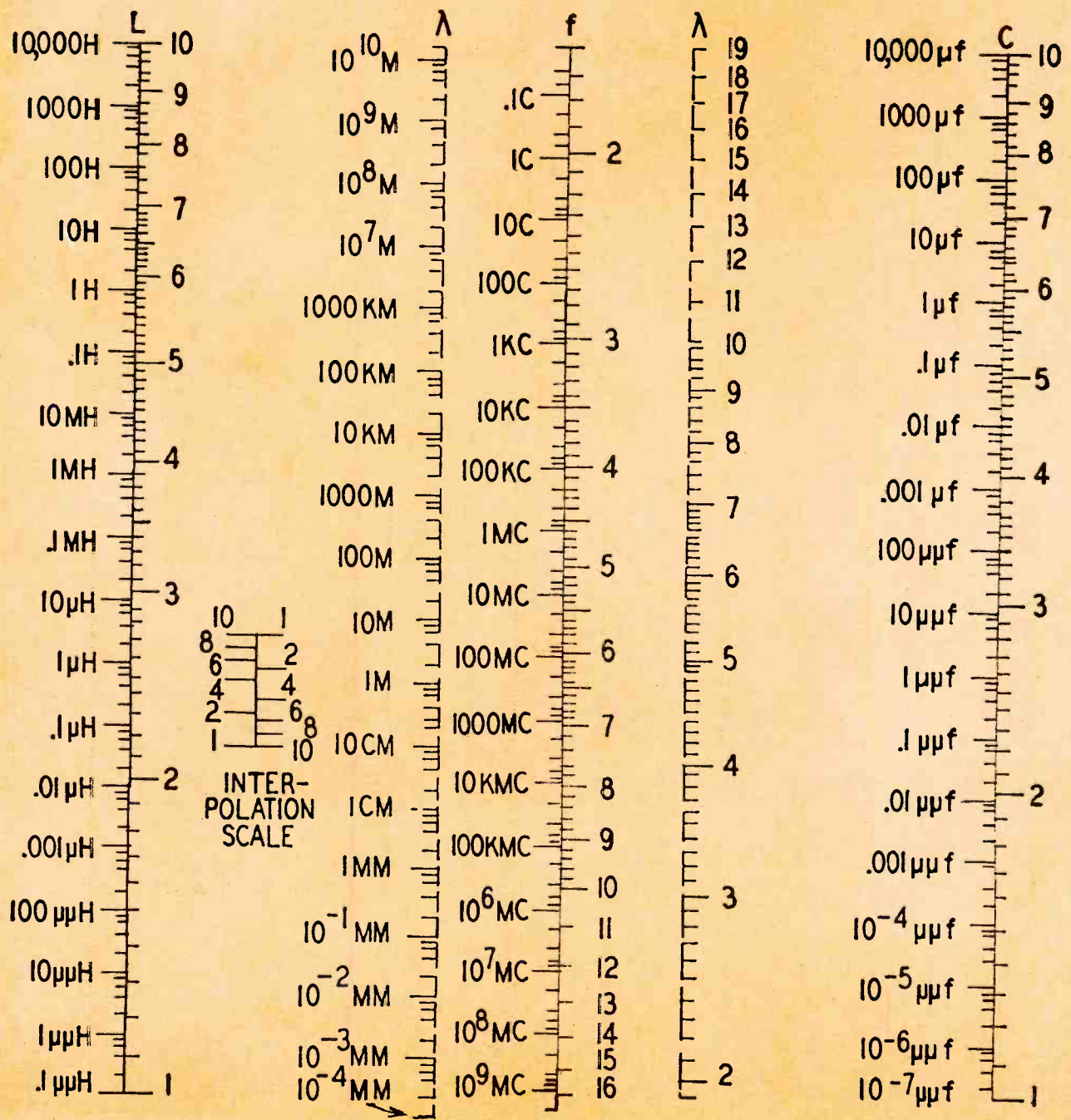

Nomograph for calculating L, C or f with the other two functions known, and for frequency-wavelength conversion.

SEVERAL graphical calculators and slide rules have been designed to solve the resonance formula

$$f = 1 / (2\pi \sqrt{LC})$$

These have the shortcomings of limited scale ranges or yield only significant figures without reference to units or order of magnitude. Folded scales or multiple charts have been employed to extend scale limits. However, these extensions tend to complicate calculations by presenting discontinuities.

The nomograph shown employs an innovation which solves the resonance formula over extreme ranges of inductance, capacitance and frequency. It is also designed for frequency-to-wavelength conversion throughout the same range. The innovation is that of including an expanded cycle on the right-hand side of the scales for the variable on the left-hand side. Thus, an approximate solution yielding the order of magnitude can be immediately obtained from the left side of the L, C and f scales. Next, an exact solution is obtained by using the right side of these same scales. The wavelength scales designed on the same basis are dashed to indicate conversion use only.

To determine a resonant frequency construct a straight line between the left-side values of L and C. Read the resonant frequency on the left side of the f scale. For a more exact solution construct a second straight line between the right side of the L and C values, using the significant figures of L and C. Read the significant resonant-frequency figures on the right side of f. Decimal location is in accordance with the left-side solution. To convert from frequency to wavelength construct a horizontal straight line through the value of frequency on the left-side f scale. Read wavelength on the left λ scale. Similarly construct a second horizontal straight line through the value of frequency on the right side of the f scale. Read significant figures on the right λ scale. The horizontal condition can be observed in both cases by equal intercepts on the L and C scales.

As an example, find the resonant frequency and wavelength of a circuit containing 1-mh inductance and .002- μ mf capacitance. Construct a straight line from 1 mh on the left side of the L scale to .002 μ mf on the left side of the C scale. Estimate 100 megacycles at the intersection of this line with the left side of the f scale. At this intersection construct a horizontal line. Estimate 3 meters on the left λ scale.

For a more exact solution construct a straight line from the bottom 1 on the right side of the L scale to 2 on the right side of the C scale. Read about 112 mc on the right side of the f scale. (For more exact reading use interpolation scale insert.) Construct a horizontal line through this intersection and read 2.67 meters on the right λ scale. Using the top 1 on the right side of the L scale would obviously be wrong since it would be incompatible with the first solution. END

Original components in these and other leading Radio and TV sets since 1948

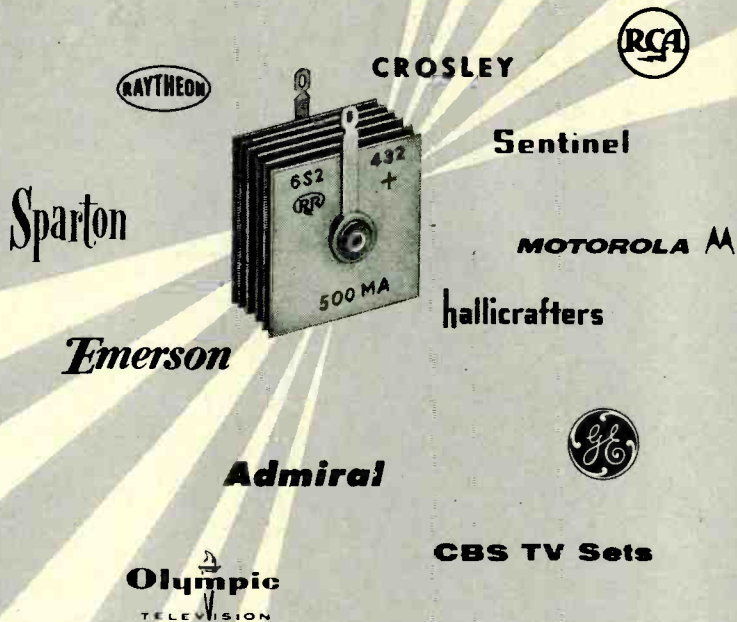

RADIO RECEPTOR

Selenium Rectifiers



That's why they're the best replacements in any Radio and TV circuit!

These famous trademarks represent a few of the many long-time users of RRco. Selenium Rectifiers. The complete list reads like a "Who's Who" in electronics.

Manufacturers' choice in so many models, RRco. "Safe Center" rectifiers are ideal replacements in any set. Your parts distributor can supply you with standard Radio Receptor replacements for sets of all radio and TV manufacturers. Demand "Safe Center" rectifiers and insure the quality of your repair work.



Semiconductor Division

RADIO RECEPTOR COMPANY, INC.

In Radio and Electronics Since 1922

240 WYTHE AVENUE, BROOKLYN 11, N. Y. • EVERGREEN 8-6000

Unique AM Tuner Improves Audio Quality

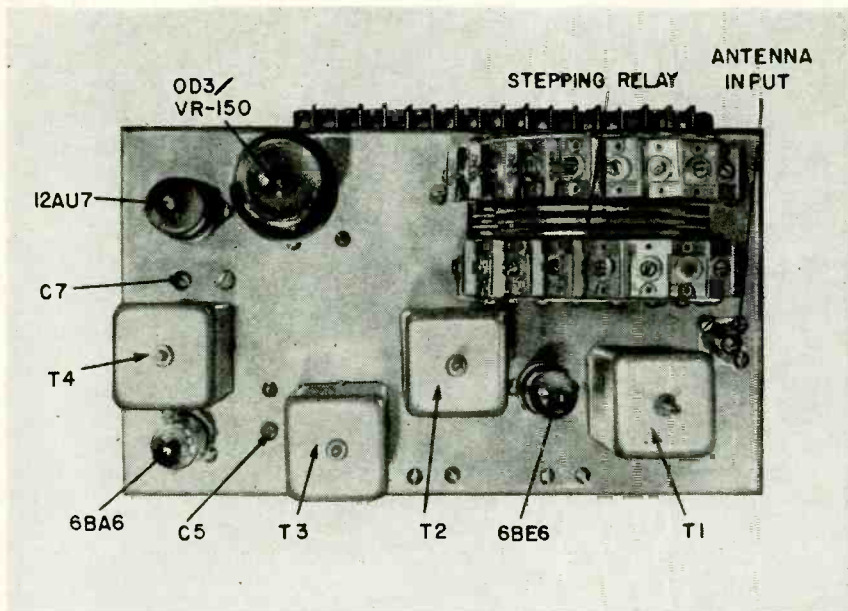

Unit provides both high selectivity and high-frequency audio response

By
PETER J. VOGELGESANG

EVEN though most AM stations do not transmit a range of audio frequencies worthy of the name *high fidelity*, the average tuner is incapable of reproducing the frequencies they do transmit. Most superheterodyne tuners are too selective for high-fidelity sound reproduction. Because of the low intermediate frequency and the multiple tuned circuits of the if transformers, the high-frequency sidebands are attenuated. A slight detuning of the average superheterodyne tuner will produce a very noticeable increase in high-frequency audio response, proof that the high frequencies are being clipped when the receiver is properly tuned.

Disregarding expensive bandpass if transformers, one solution to the problem of high-frequency sideband clipping is to use fewer tuned circuits in the tuner. However, this is apt to reduce the selectivity to the point where adjacent stations produce interference—one of the chief objections to the tuned-

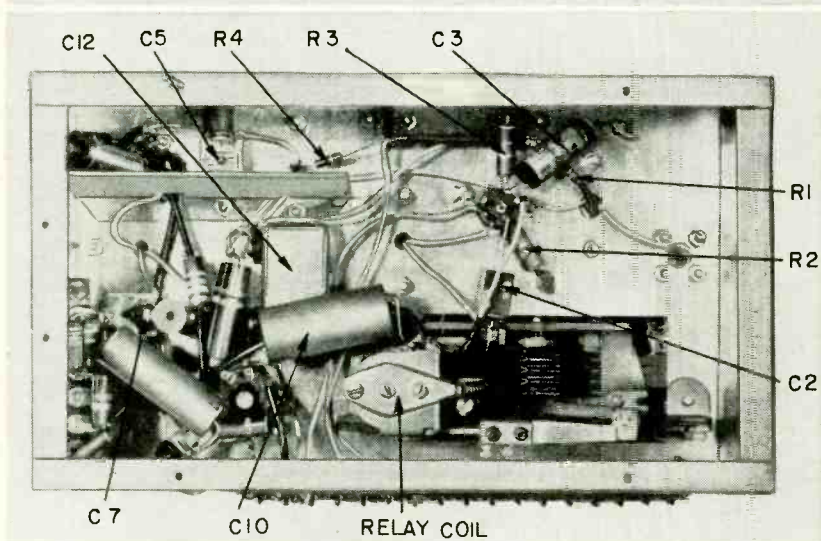

Top—Top view. Lineup of cans give unit appearance of conventional superhet. Bottom—An underchassis view of the tuner.

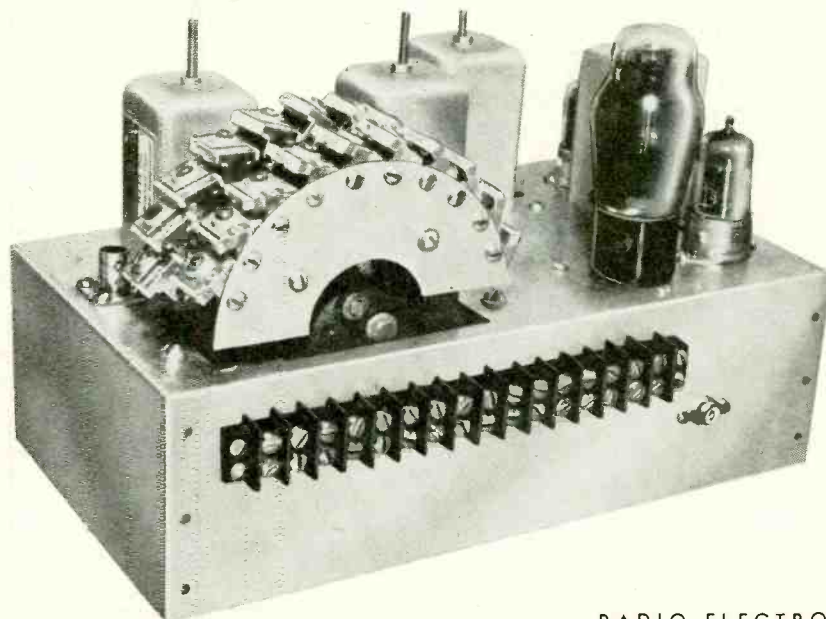

The unique AM tuner

sequence and cannot return to position 1 until it has stepped through its final position.

The location at which this tuner was installed did not require a station indication system because the individuals using it did not care what station they were listening to as long as the program material suited their tastes. However, others would surely want a station indication system.

The simplest system would be to wire the unused group of stepping relay terminals to a row of 10 indicator lights mounted at the point of remote control. Each light would designate one of the pretuned stations and the lights would glow in order as the stepping-relay control button was pushed.

Stepping relays, while generally expensive, can be purchased from the surplus markets rather reasonably. If a stepping relay with a release coil and spring return can be procured, a telephone dial would provide an excellent method of controlling the tuner with but a single control line.

The trimmer capacitors that tune the oscillator and the rf input circuit are mounted on the stepping relay. One terminal of each capacitor is soldered to a lug of the relay and the other terminal is screwed to a half-circle of sheet aluminum. The whole unit is constructed ruggedly and mounted firmly to the chassis to insure maximum oscillator stability. The oscillator stability is increased even more by supply voltage regulation.

The tuner is constructed on a 5 x 10 x 3-inch chassis. Supply voltages and one group of stepping-relay terminals are brought to a terminal strip on the side of the chassis. The audio output is brought to a separate connector. The variable resistors used to adjust the output amplitude of the tuner are mounted on the power supply instead of the tuner. The 380- μ f trimmers which tune the secondaries of the rf transformers are mounted beneath the chassis and are available for adjustment through holes drilled in its top.

The tuner is aligned the same as any superheterodyne unit. Some unused frequency on the low end of the local broadcast band should be chosen for the intermediate frequency. The higher this frequency the broader the bandpass; the lower the frequency the sharper the bandpass. The rf tuned circuit and local oscillator are tuned for each station independently.

Performance is excellent. It develops just about the maximum in AM fidelity. The announcers' S's sound crisp and clean.

The tuner also presents a remote control feature that will fit ideally into custom radio and sound installations. It could be mounted in the trunk of an automobile and controlled from the dash panel with but a single switch, leaving precious dash-panel space available for other equipment. **END**

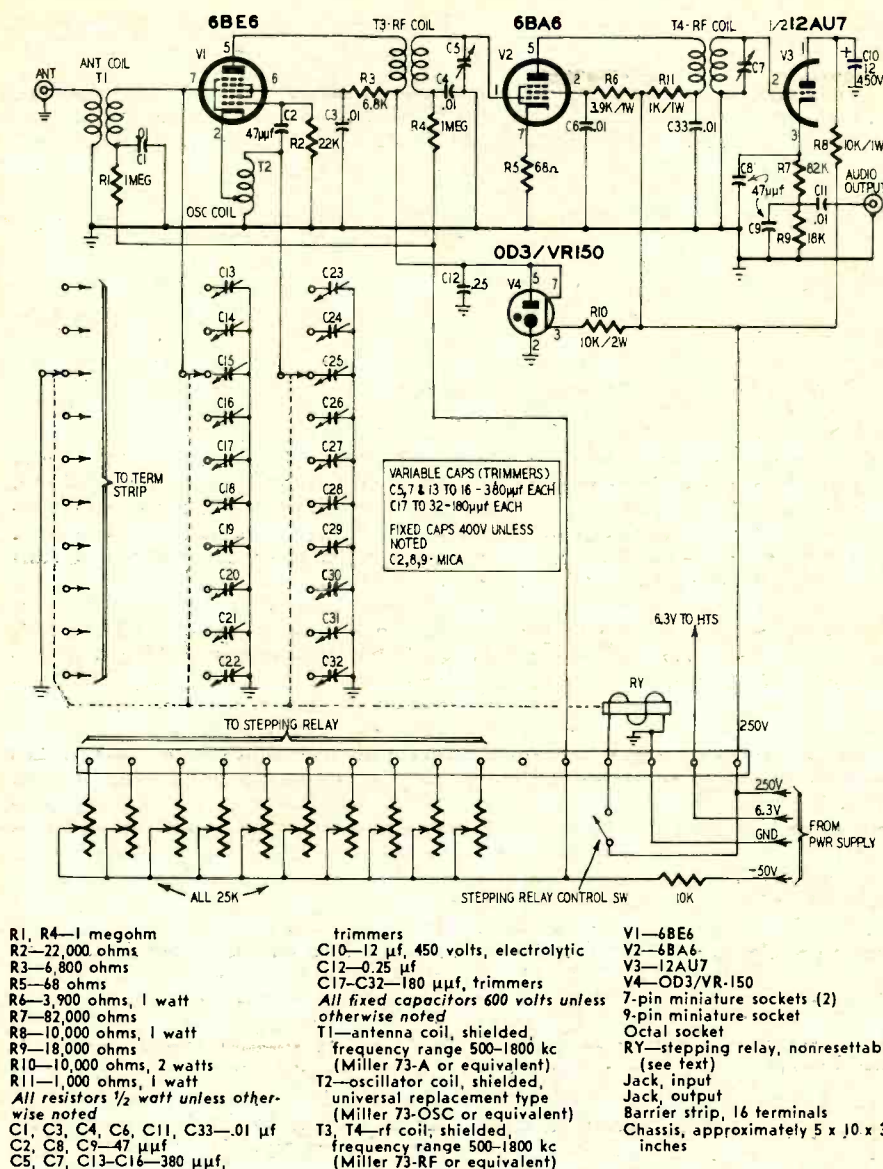

- R1, R4—1 megohm
- R2—22,000 ohms
- R3—6,800 ohms
- R5—48 ohms
- R6—3,900 ohms, 1 watt
- R7—82,000 ohms
- R8—10,000 ohms, 1 watt
- R9—18,000 ohms
- R10—10,000 ohms, 2 watts
- R11—1,000 ohms, 1 watt
- All resistors 1/2 watt unless otherwise noted
- C1, C3, C4, C6, C11, C33—.01 μ f
- C2, C8, C9—47 μ f
- C5, C7, C13—C16—380 μ f, trimmers
- C10—12 μ f, 450 volts, electrolytic
- C12—0.25 μ f
- C17—C32—180 μ f, trimmers
- All fixed capacitors 600 volts unless otherwise noted
- T1—antenna coil, shielded, frequency range 500-1800 kc (Miller 73-A or equivalent)
- T2—oscillator coil, shielded, universal replacement type (Miller 73-OSC or equivalent)
- T3, T4—rf coil, shielded, frequency range 500-1800 kc (Miller 73-RF or equivalent)
- V1—6BE6
- V2—6BA6
- V3—12AU7
- V4—OD3/VR-150
- 7-pin miniature sockets (2)
- 9-pin miniature socket
- Octal socket
- RY—stepping relay, nonresettable (see text)
- Jack, input
- Jack, output
- Barrier strip, 16 terminals
- Chassis, approximately 5 x 10 x 3 inches

The high-fidelity tuner. Power supply and bias resistors are on separate chassis.

radio-frequency receiver. Thus, selectivity seems to have an optimum value somewhere between maximum high-frequency response and maximum station selectivity.

This tuner comes close to this optimum value by tuning each station in the band with separate rf and oscillator tuning capacitors. The effects of an interfering station can be greatly reduced by slightly detuning the rf stage to the side of the desired station that has no interference. The rf input and the oscillator circuits are tuned by pairs of trimmer capacitors mounted on a stepping relay. Stations are changed simply by pulsing the coil of the stepping relay. The rf transformers used instead of if's provide much greater bandpass than standard if transformers and require an intermediate frequency above 600 kc. The higher if also contributes to the greater bandpass. Because each station is tuned individually, the tracking problem is eliminated and stations can be tuned to maximum sharpness. Only

the secondaries of the rf transformers are tuned, by 380- μ f trimmers.

An infinite-impedance detector is used for better fidelity and greater sensitivity. Since the infinite-impedance detector provides no avc voltage, a substitute bias voltage is provided. A negative 50 volts is dropped through a separate variable resistor for each position of the stepping relay. The resistors can be adjusted permanently to compensate for the relative signal strengths of stations. While avc is simpler, it is not completely adequate because most receivers require adjustment of the audio gain control when stations are changed. With the system used in this tuner, the output can be adjusted to *exactly* the same level for all stations. An ordinary avc voltage could be provided easily with a crystal diode or by using the unused half of the 12AU7 as a diode with the grid and plate tied together.

The stepping relay used to switch the tuning capacitors is a nonresettable type; that is, it steps in an ordered

TRANSISTOR RADIOS

By I. QUEEN
EDITORIAL ASSOCIATE

Part VII—The Magnavox AM2, Hallicrafters TR-88; receiver repair and alignment

THIS, the last in this series on transistor radios, describes a few more models and then finishes up with general servicing and alignment procedure. We hope this provides the technician with sufficient data to repair and adjust a transistor receiver. In any case it is recommended that the schematic be on hand to aid whenever one of these radios is serviced.

Magnavox Companion, model AM2

This radio chassis, coded CR 729 AA, is a six-transistor set with class-B output. It measures 3¼ x 5¼ x 1¼ inches and is capable of a maximum output of 90 mw; it weighs 20 ounces with battery. The battery delivers 4 volts and lasts about 200 hours. A personal earpiece is provided for; it automatically disconnects the speaker.

The converter stage is conventional. (See Fig. 1.) Feedback between collector and emitter windings provides oscillation. Like the other high-frequency circuits this stage uses an n-p-n transistor.

Both if stages are neutralized by capacitance in series with resistance. The if strip requires either a pair of 2N146 transistors (as shown) or it may use a 2N145 for V2 and a 2N147 for V3. Otherwise, neutralization may be upset and the output lowered. The last if transformer, bifilar-wound, is tapped. One terminal feeds the diode detector; the opposite one provides the out-of-phase voltage for neutralization.

The diode produces a negative voltage across the volume control. After suitable filtering, this becomes the avc signal which is fed to V2.

The audio transistors are Texas In-

strument p-n-p types. A common resistor R is in the emitter returns of both V4 and the class-B stage. The drop across R provides the small bias required for the class-B transistors during low-signal periods. Ordinarily this bias is obtained by a voltage divider which results in wasted power. The circuit shown here is, therefore, more efficient. The speaker is a 2¾-inch unit with a nominal impedance of 16 ohms.

Hallicrafters El Diablo TR-88

This is a six-transistor set using all p-n-p types. The power supply is 6 volts (four No. 2 flashlight cells). These snap into clips, two at each end of the receiver case. The diagram appears in Fig. 2, with voltages given at each transistor element. The transistors may be as follows: V1, 2N112 or 2N136; V2 and V3, 2N112, 2N135 or 2N139; V4, 2N109, 2N191 or TI310; V5 and V6, 2N109, 2N186 or TI352.

The mixer supplies 455 kc to the if strip. Both if stages are neutralized by trimmer capacitors. Thus each stage may be set to optimum at any time. Each if transformer is tapped, and it is the primary which supplies the out-of-phase neutralization voltage.

The detector produces a positive avc voltage across the volume control, which is then applied to both V2 and V3. The audio stages are transformer-coupled, and the output is class B. This stage receives its bias from a voltage divider. The speaker impedance is 11 ohms.

Receiver maintenance

Transistors are more rugged mechan-

ically than tubes, but electrically and thermally they are more delicate. Therefore the new sets require a different servicing procedure, and special precautions must be observed in handling them.

Transistors often have a maximum storage temperature of 85°C (185°F), and the maximum operating temperature may be 50°C (122°F). The temperature limit varies with the power dissipated in the transistor. *Never* place a transistor radio near a hot radiator or on the rear window shelf of an automobile where a high temperature may exist. *Always* remove transistors from their sockets before soldering near them.

Never remove or plug a transistor into its socket while voltage is applied. *Always* turn off the power first. Transistors should be removed from their sockets before making resistance measurements. This is necessary for two reasons: it prevents erroneous readings (the resistance between transistor elements is relatively low); it eliminates danger to the transistors from excessive current flow from the ohmmeter.

In checking a tube radio many technicians first test the tubes. A different procedure is recommended for a transistor radio. There is little likelihood that a transistor has gone bad under ordinary operation; its life is indefinite and it cannot burn out under normal conditions. A more logical first step is to test the battery. A weak battery can cause instability and regeneration and may result in low sensitivity and volume. Generally a 9-volt battery will give satisfactory service down to even 6

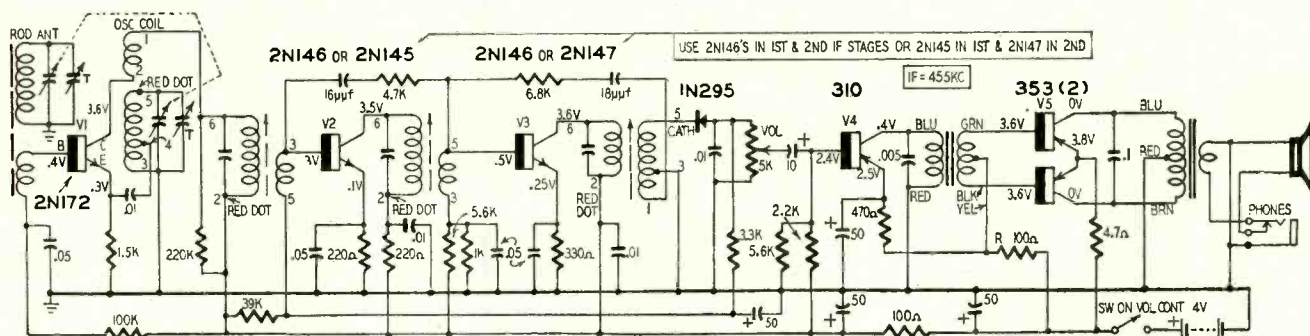

Fig. 1—Schematic diagram of Magnavox Companion, model AM2. Set uses six transistors and has if of 455 kc.

... another
MALLORY
service-engineered
product



MALLORY *Mercury* BATTERIES...

Leading line for transistor portables

Cash in on the growing battery replacement market for transistorized portables—with the line that offers you an unequalled combination of prestige and profit.

Mallory pioneering of mercury batteries helped make these new miniature radios possible. Leading set makers supply Mallory Mercury batteries in original equipment... recommend them to set owners, too!

Mallory performance builds business, assures repeat sales and profit to you. They're the value leader, because they cost *less* per hour of operation.



SPECIAL INTRODUCTORY BATTERY MERCHANDISER

Because of the remarkable shelf life of Mallory Mercury Batteries, now for the first time you can stock batteries without fear of inventory loss. This introductory assortment covers all popular transistor portables. No extra charge for the display unit! Order yours today!

P. R. MALLORY & CO. Inc.
MALLORY

P. R. MALLORY & CO. Inc., INDIANAPOLIS 6, INDIANA

- Capacitors
- Vibrators
- Resistors
- Power Supplies
- Mercury Batteries
- Controls
- Switches
- Rectifiers
- Filters

RADIO

be connected across the emitter resistor (of the converter stage) to show whether or not any oscillations are present.

In some models (for example, Hallicrafters) the injected rf voltage from the oscillator may be varied. Normally the voltage (as measured by an rf voltmeter) is set to .06 across the emitter resistance (converter stage). It can be adjusted by breaking the wax seal on the oscillation transformer and changing the coupling between windings as required. The windings should be resealed after setting the adjustment. The Hallicrafters portable calls for a voltage of .06 with the tuning gang closed. It should not exceed 0.15 volt with the gang wide open.

The injected voltage may have to be adjusted when the converter transistor is replaced. With too low voltage oscillations may cease, especially at the low-frequency end of the dial and when the batteries are slightly low. Too high a voltage may cause superregenerative action or squegging at the high-frequency end.

Transistor sets use tiny electrolytic or tantalum capacitors of very high capacitance. When capacitance drops, the result may be oscillation or low gain. The best check is to shunt a good capacitor across the doubtful one. If there is considerable improvement, remove the questionable unit.

Many transistor portables use a push-pull class-B stage to feed the speaker. Normally the two transistors are matched as to gain and cutoff current. If it should become necessary to replace one of the transistors, both should be removed and a matched pair plugged in. Otherwise distortion and lowered output may result.

When a converter or if transistor is replaced, it is best to realign the receiver. This procedure is somewhat similar to that for a tube set—the if strip is first aligned, then the rf circuits. It is important to keep the input signal low to prevent overloading the transistors, especially those in the class-B stage. A class-B transistor passes current in proportion to its output. When overloaded, the output current rises to a dangerous value.

Alignment procedure

Practically all transistor sets have an if of 455 kc, so any conventional modulated if signal generator may be used. A fiber alignment tool is recommended to eliminate hand capacitance and to prevent chipping the ferrite core slots of the transformers.

The first step is to align the if strip.

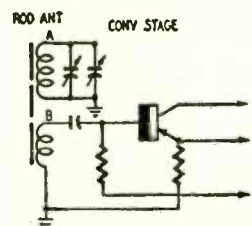

Fig. 6—Generator connecting points.

RADIO

Couple the if generator loosely to the receiver loop through a .005- μ f or larger capacitor. The low side of the generator connects to the chassis, the high side (through the capacitor) either to the primary or secondary of the loop. For example, points A or B of Fig. 6 may be the connecting points. Keeping the if output low, the transformers are aligned in reverse order, that is, starting with the last stage. A vtvm or output meter is connected across the speaker. If the output stage is class B, a meter in series with the battery will make a suitable output indicator. Tune each transformer for maximum output. *Keep the if signal generator output as low as possible.* The if circuits are generally aligned with the tuning capacitor *open* or at least tuned to a quiet spot near 1600 kc.

The rf is best aligned with a radiation loop of about 5 turns, each 2 inches in diameter. This loop is placed a foot or two from the antenna loop of the receiver. Tune the signal generator to 1620 kc, connect the loop across its terminals and tune the receiver to 1620 kc. Now the *oscillator trimmer* is adjusted for maximum output. Next tune the generator and the receiver to about 550 kc. Tune the *oscillator coil slug* for maximum output. This adjustment is often made while the receiver dial is *rocked* back and forth slightly near 550 kc. Next, the generator and receiver are both set to 1400 kc while the *antenna trimmer* is set, again for maximum output. The above steps are repeated until no further improvement is noted.

An if signal may be injected directly to the base of the converter. An rf signal injected at this point will probably stop oscillator action.

A simpler and more accurate if alignment is recommended by Hallicrafters. However this requires a sweep generator having a center frequency of 455 kc and a sweep of 10 kc. An oscilloscope is connected across the volume control to observe the output waveform of the if strip. It should appear somewhat like that of Fig. 7. Spurious responses or peaks along the curve indi-

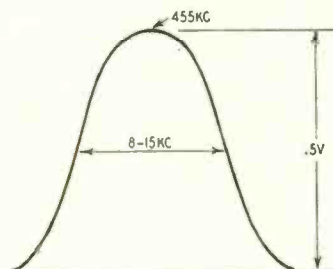

Fig. 7—Hallicrafters if response.

cate that neutralization is incomplete. Adjust each if to obtain a smooth curve.

Many schematics given in this series of articles indicated voltage values at each transistor element. These are useful in troubleshooting. Voltages should be measured with a vtvm or with a high resistance non-electronic voltmeter. END

... another
MALLORY
service-engineered
product



FP CAPACITORS take high ripple currents (all FP's are Mallory)

No need to worry about ripple currents, when you choose Mallory FP (fabricated plate) capacitors for replacement. They're built to handle the toughest ripple . . . even the values you find in the latest color TV sets.

FP's, in fact, will stand 50 to 100% higher ripple current than usual industry expectation for a given rating. And this superior performance . . . proved by tests at 85° C ambient . . . can be expected of all FP capacitors, for they are manufactured to highest standards of uniformity. Mallory's unique FP constructor makes this possible. It puts more electrolyte and more anode area into a smaller case . . . to give better heat dissipating qualities.

Be sure to specify Mallory FP's by name, not only for high ripple applications, but for all your electrolytic capacitor replacements. See your local Mallory distributor today!

P. R. MALLORY & CO. Inc.
MALLORY

P. R. MALLORY & CO. Inc., INDIANAPOLIS 6, INDIANA

- Capacitors
- Controls
- Vibrators
- Switches
- Resistors
- Rectifiers
- Power Supplies
- Filters
- Mercury Batteries



Superior's New
Model TC-55

TUBE TESTER

FOR The Experimenter or Part-time Serviceman, who has delayed purchasing a higher priced Tube Tester. The Professional Serviceman, who needs an extra Tube Tester for outside calls. The busy TV Service Organization, which needs extra Tube Testers for its field men.

Speedy, yet efficient operation is accomplished by:

1. Simplification of all switching and controls.
2. Elimination of old style sockets used for testing obsolete tubes (26, 27, 57, 59, etc.) and providing sockets and circuits for efficiently testing the new Noval and Sub-Minar types.

You can't insert a tube in wrong socket
It is impossible to insert the tube in the wrong socket when using the new Model TC-55. Separate sockets are used, one for each type of tube base. If the tube fits in the socket it can be tested.

"Free-point" element switching system
The Model TC-55 incorporates a newly designed element selector switch system which reduces the possibility of obsolescence to an absolute minimum. Any pin may be used as a filament pin and the voltage applied between that pin and any other pin, or even the "top-cap"

Checks for shorts and leakages between all elements
The Model TC-55 provides a super sensitive method of checking for shorts and leakages up to 5 Megohms between any and all of the terminals. Continuity between various sections is individually indicated. This is important, es-

pecially in the case of an element terminating at more than one pin. In such cases the element or internal connection often completes a circuit.

Elemental switches are numbered in strict accordance with R.M.A. specification.

One of the most important improvements, we believe, is the fact that the 4 position fast-action snap switches are all numbered in exact accordance with the standard R.M.A. numbering system. Thus, if the element terminating in pin No. 7 of a tube is under test, button No. 7 is used for that test.

The Model TC-55 comes complete with operating instructions and charts. Housed in rugged steel cabinet. Use it on the bench—use it for field calls. A streamlined carrying case, included at no extra charge, accommodates the tester and book of instructions.

\$26⁹⁵ NET



Superior's new
Model TV-11

TUBE TESTER

★ Tests all tubes including 4, 5, 6, 7, Octal, Lock-in, Peanut, Bantam, Hearing Aid, Thyatron Miniatures, Sub-miniatures, Novals, Sub-minars, Proximity fuse types, etc.

★ Uses the new self-cleaning Lever Action Switches for individual element testing. Because all elements are numbered according to pin-number in the RMA base numbering system, the user can instantly identify which element is under test. Tubes having tapped filaments and tubes with filaments terminating in more than one pin are truly tested with the Model TV-11 as any of the pins may be placed in the neutral position when necessary.

EXTRA SERVICE—The Model TV-11 may be used as an extremely sensitive Condenser Leakage Checker. A relaxation type oscillator incorporated in this model will detect leakages even when the frequency is one per minute.

★ The Model TV-11 does not use any combination type sockets. Instead individual sockets are used for each type of tube. Thus it is impossible to damage a tube by inserting it in the wrong socket.

★ Free-moving built-in roll chart provides complete data for all tubes.

★ Newly designed Line Voltage Control compensates for variation of any Line Voltage between 105 Volts and 130 Volts.

★ NOISE TEST: Phono-jack on front panel for plugging in either phones or external amplifier will detect microphonic tubes or noise due to faulty elements and loose internal connections.

The model TV-11 operates on 105-130 Volt 60 Cycles A.C. Comes housed in a beautiful hand-rubbed oak cabinet complete with portable cover.

\$47⁵⁰ NET

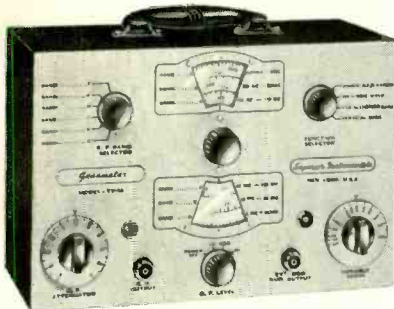

Superior's New
Model TV-50

GENOMETER

A versatile all-inclusive GENERATOR which provides ALL the outputs for servicing:
A. M. Radio • F. M. Radio • Amplifiers • Black and White TV • Color TV

7 Signal Generators in One!

- ✓ R.F. Signal Generator for A.M.
- ✓ R.F. Signal Generator for F.M.
- ✓ Audio Frequency Generator

- ✓ Bar Generator
- ✓ Cross Hatch Generator
- ✓ Color Dot Pattern Generator
- ✓ Marker Generator

R. F. SIGNAL GENERATOR: The Model TV-50 Genometer provides complete coverage for A.M. and F.M. alignment. Generates Radio Frequencies from 100 Kilocycles to 60 Megacycles on fundamentals and from 60 Megacycles to 180 Megacycles on powerful harmonics.

VARIABLE AUDIO FREQUENCY GENERATOR: In addition to a fixed 400 cycle sine-wave audio, the Model TV-50 Genometer provides a variable 300 cycle to 20,000 cycle peaked wave audio signal.

BAR GENERATOR: The Model TV-50 projects an actual Bar Pattern on any TV Receiver Screen. Pattern will consist of 4 to 16 horizontal bars or 7 to 20 vertical bars.

CROSS HATCH GENERATOR: The Model TV-50 Genometer will project a cross-hatch pattern on any TV picture tube. The pattern will consist of non-shifting horizontal and vertical lines interlaced to provide a stable cross-hatch effect.

MARKER GENERATOR: The Model TV-50 includes all the most frequently needed marker points. The following markers are provided: 180 Kc., 262.5 Kc., 450 Kc., 600 Kc., 1000 Kc., 1400 Kc., 1800 Kc., 2000 Kc., 2500 Kc., 3579 Kc., 4.5 Mc., 5 Mc., 10.7 Mc. (3579 Kc. is the color burst frequency.)

THE MODEL TV-50 comes absolutely complete with shielded leads and operating instructions.

\$47⁵⁰ NET

Only

DOT PATTERN GENERATOR (FOR COLOR TV): Although you will be able to use most of your regular standard equipment for servicing Color TV, the one addition which is a "must" is a Dot Pattern Generator. The Dot Pattern projected on any color TV Receiver tube by the Model TV-50 will enable you to adjust for proper color convergence.

Superior's New
Model TV-40

PICTURE TUBE TESTER

NOT A GADGET—NOT A MAKE-SHIFT ADAPTER, BUT A WIRED PICTURE TUBE TESTER WITH A METER FOR MEASURING DEGREE OF EMISSION—AT ONLY \$15.85

Of course you can buy an adapter for about \$5—which theoretically will convert your standard tube tester into a picture-tube tester; or a neon type instrument which sells for a little more and is supposed to be "as good as" a metered instrument. Superior does not make nor do they

recommend use of C.R.T. adapters or neon gadgets because a Cathode Ray Tube is a very complex device, and to properly test it, you need an instrument designed exclusively to test C.R. Tubes and nothing else.

Tests ALL magnetically deflected tubes... in the set... out of the set... in the carton!!

- Tests all magnetically deflected picture tubes from 7 inch to 30 inch types.
- Tests for quality by the well established emission method. All readings on "Good-Bad" scale.
- Tests for inter-element shorts and leakages up to 5 megohms.
- Test for open elements.

EASY TO USE: Simply insert line cord into any 110 volt A.C. outlet, then attach tester socket to tube base (Ion trap need not be on tube). Throw switch up for quality test... read direct on Good-Bad scale. Throw switch down for all leakage tests.

Model TV-40 C.R.T. Tube Tester comes absolutely complete—nothing else to buy. Housed in round cornered, molded bakelite case. Only

\$15⁸⁵ NET



EXAMINE BEFORE YOU BUY!
USE APPROVAL FORM ON NEXT PAGE

For the first time ever: ONE TESTER PROVIDES ALL THE SERVICES LISTED BELOW!

Superior's
New Model

76



IT'S A CONDENSER BRIDGE

with a range of .00001 Microfarad to 1000 Microfarads (Measures power factor and leakage too.)

IT'S A RESISTANCE BRIDGE

with a range of 100 ohms to 5 megohms

IT'S A SIGNAL TRACER

which will enable you to trace the signal from antenna to speaker of all receivers and to finally pinpoint the exact cause of trouble whether it be a part or circuit defect.

IT'S A TV ANTENNA TESTER

The TV Antenna Tester section is used first to determine if a "break" exists in the TV antenna and if a break does exist the specific point (in feet from set) where it is.

Specifications

✓CAPACITY BRIDGE SECTION

4 Ranges: .00001 Microfarad to .005 Microfarad; .001 Microfarad to .5 Microfarad; .1 Microfarad to 50 Microfarads; 20 Microfarads to 1000 Microfarads. This section will also locate shorts, and leakages up to 20 megohms. And finally, this section will measure the power factor of all condensers from .1 to 1000 Microfarads. (Power factor is the ability of a condenser to retain a charge and thereby filter efficiently.)

✓RESISTANCE BRIDGE SECTION

2 Ranges: 100 ohms to 50,000 ohms; 10,000 ohms to 5 megohms. Resistance can be measured without disconnecting capacitor connected across it. (Except, of course, when the R C combination is part of an R C bank.)

✓SIGNAL TRACER SECTION

A built-in high gain pentode voltage amplifier, plus a diode rectifier, plus a direct coupled triode amplifier are combined to provide this highly sensitive signal tracing service. With the use of the R.F. and A.F. Probes included with the Model 76, you can make stage gain measurements, locate signal loss in R.F. and Audio stages, localize faulty stages, locate distortion and hum, etc. Provision has been made for use of phones and meter if desired.

✓TV ANTENNA TESTER SECTION

Loss of sync., snow and instability are only a few of the faults which may be due to a break in the antenna, so why not check the TV antenna first? The Model 76 will enable you to locate a break in any TV antenna and if a break does exist, the Model 76 will measure the location of the break in feet from the set terminals. 2 Ranges: 2' to 200' for 72 ohm coax and 2' to 250' for 300 ohm ribbon.

As Design Engineers, we the undersigned would like to say that the Model 76 is in our opinion the best combination unit of its kind we have been privileged to design. Although it is comparatively a low-priced tester, it will, after you become acquainted with its multiple services, be your most frequently used instrument.

S. LITT
L. MELENKEVITZ

Model 76 comes complete with all accessories including R.F. and A.F. Probes; Test Leads and operating instructions. Nothing else to buy.
Only

\$ **26**⁹⁵ NET

SHIPPED ON APPROVAL NO MONEY WITH ORDER — NO C.O.D.

Try any of the instruments on this or the facing page for 10 days before you buy. If completely satisfied then send down payment and pay balance as indicated on coupon. No Interest or Finance Charges Added! If not completely satisfied return unit to us, no explanation necessary.

MOSS ELECTRONIC DISTRIBUTING CO., INC.

Dept. D-303, 3849 Tenth Ave., New York 34, N. Y.

Please send me the units checked. I agree to pay down payment within 10 days and to pay the monthly balance as shown. It is understood there will be no finance or interest charges added. It is further understood that should I fail to make payment when due, the full unpaid balance shall become immediately due and payable.

Model TV-11.....Total Price \$47.50
\$11.50 within 10 days. Balance \$6.00
monthly for 6 months.

Model 76.....Total Price \$26.95
\$6.95 within 10 days. Balance \$5.00
monthly for 4 months.

Model TC-55.....Total Price \$26.95
\$6.95 within 10 days. Balance \$5.00
monthly for 4 months.

Model TV-50.....Total Price \$47.50
\$11.50 within 10 days. Balance \$6.00
monthly for 6 months.

Model TV-40.....Total Price \$15.85
\$3.85 within 10 days. Balance \$4.00
monthly for 3 months.

Name.....

Address.....

City..... Zone..... State.....

All prices net, F.O.B., N. Y. C.

portable loop homing antenna

By BEN CRISSSES and JAY GNESSIN

Collapsible unit on walkie-talkie permits taking rapid fix on stations; excellent for quick bearing and homing

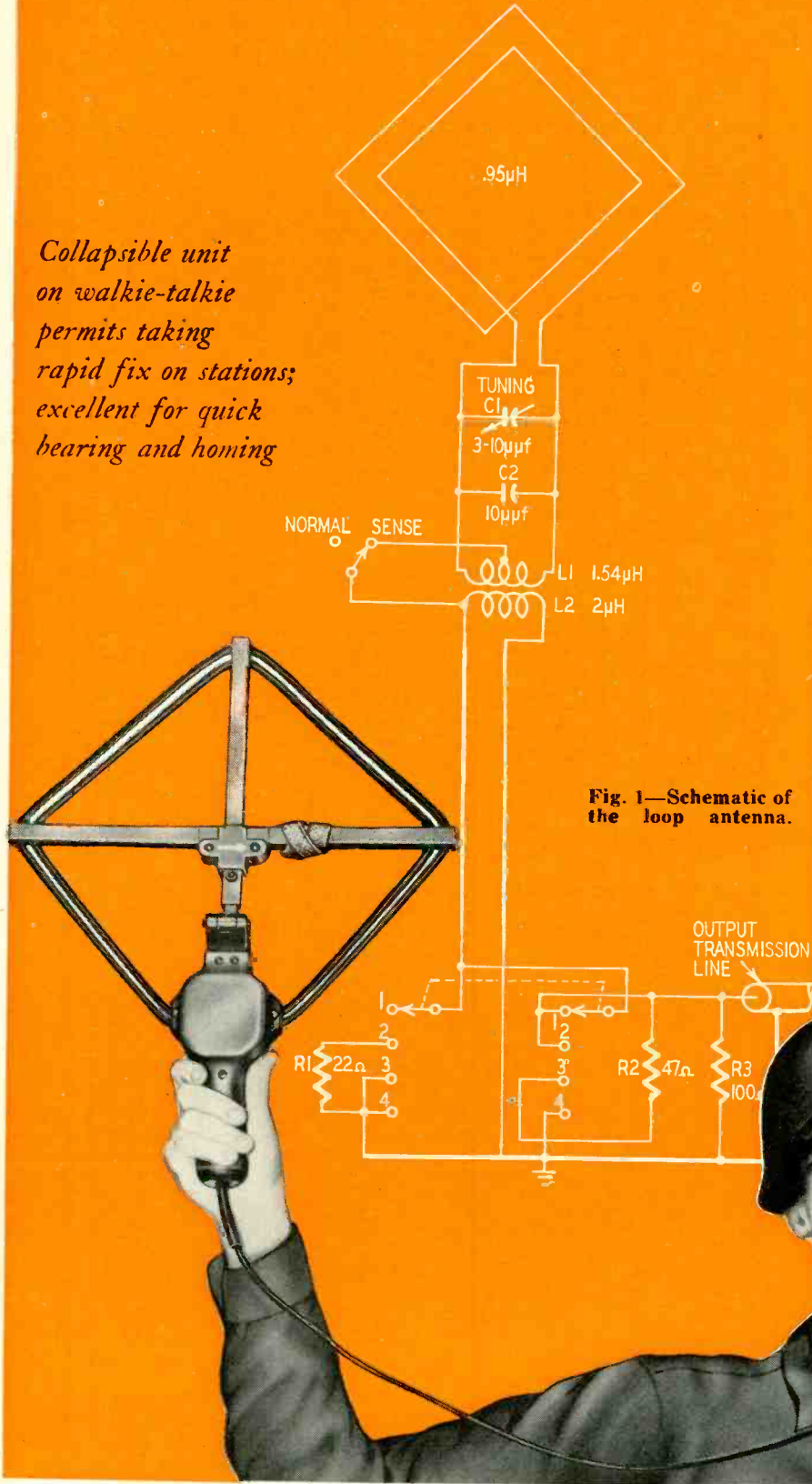

Fig. 1—Schematic of the loop antenna.

THE portable-loop homing antenna shown on facing page, attached to a walkie-talkie set (the AN/PRC-6), permits an operator to take a quick bearing on a transmitting station, to *home* on that station or take a *fix* on two or more stations. It may also be used as a conventional transmitting and receiving antenna for distances up to a mile.

Replacing the whip antenna normally used in the 50-mc band, the loop is held in the operator's hand during transmission, reception and direction finding. The operator rotates the antenna while listening for changes in signal strength.

The loop antenna weighs approximately 2 pounds. It is made of plastic, collapsing into a small bundle when not in use. When fully extended it is approximately 20 inches high, measuring approximately 15 inches across the diagonal.

The loop proper is made of a pair of rubber-covered conductors in parallel. No shielding is used. The base of the loop terminates in a tuned circuit in the plastic handle. The rubber-covered transmission line then leads directly through the handle of the loop to the receiver input.

The detailed schematic diagram is shown in Fig. 1. The loop forms the inductance of a tuned circuit, loaded by capacitor C2 and tuned by capacitor C1. The signal is fed to L1, the primary of the antenna transformer. The secondary, L2, has an attenuating switching circuit (two banks of switches ganged) with four steps of attenuation. The antenna output is fed through a transmission line to the radio set.

Radio receiving antennas are generally cut to half-waves of the transmitted frequency. When the antenna is strung horizontally, it intercepts maximum signal from directions perpendicular to its length (Fig. 2-a). Reception from the ends of the antenna is nil.

If the same antenna is rotated 90° so it stands on end, it becomes a vertical antenna having a circular reception pattern (Fig. 2-b). Now it may be considered nondirectional.

Loop antenna in use in field.

Photos courtesy U.S. Army

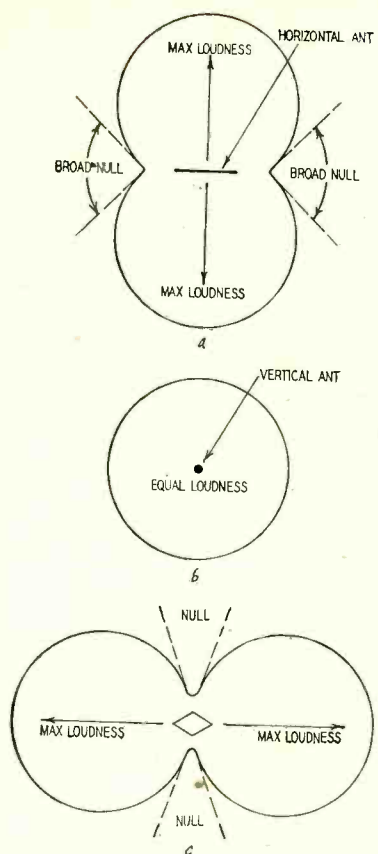

Fig. 2—Antenna reception patterns.

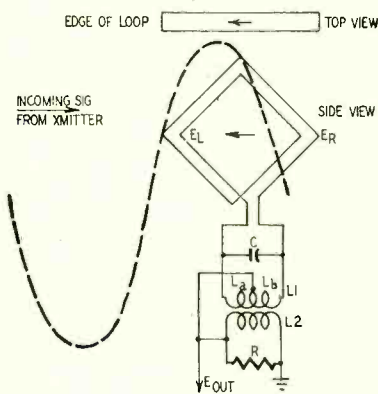

Fig. 3—The loop circuit simplified.

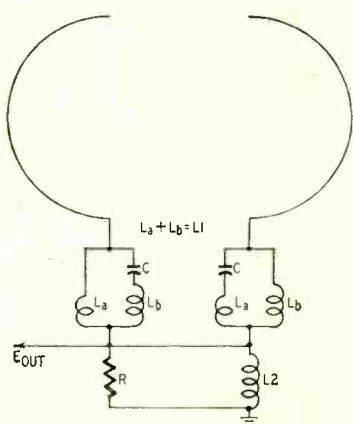
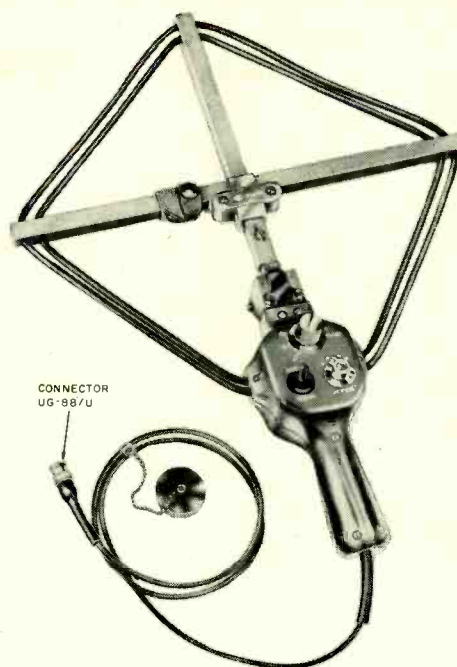

Fig. 4.—Equivalent loop circuitry.



The portable-loop homing antenna. Unit contains tuning, normal-sense and attenuator controls.

If the receiving antenna is shaped into a loop, placed vertically in space, it will show a pronounced directional pattern in the direction of its front and back edges.

In Fig. 2-c the direction at right angles to the plane of the loop is insensitive to the signal. This is the null; it is always at right angles to the strong signal zone.

The loop circuit is simplified in Fig. 3 and further simplified in Fig. 4. Assume the NORMAL-SENSE switch (Fig. 1) is closed. This switch distinguishes the *to* and *from* directions of the line of signal toward and away from the transmitter. *Sense* distinguishes one direction from the other by making the signal stronger than the signal away from the station.

The sense signal is developed as follows: At the operating frequency, L_a , L_b , and C form a resonant circuit in series with the parallel combination of R and L_2 . The impedance of the resonant circuit is so much larger than R and L_2 that these two elements may be ignored in the overall circuit, which now may be considered as a resistive circuit to ground. In such a circuit, the *sense voltage* is in phase with the signal voltage in free space.

While it is true that in the overall circuit the voltages are in phase, E_{out} is taken across L_2 . Across this coil E_{out} leads the space signal voltage since L_2 is an essentially pure inductance. This is the *sense voltage output*.

Note that this is the same effect as if a single vertical wire had been used as an omnidirectional receiving antenna. Other direction-finding systems use a separate vertical sense antenna. However, for portability, the loop itself, switched to the coil-resistor circuit, to ground replaces the vertical wire.

Now consider what happens to the loop action (Fig. 5-a). When a signal

arrives, it intercepts sides L and R , inducing voltages in the same direction in each loop side. These would normally buck each other, causing complete cancellation. However, the voltages are not induced simultaneously, since the signal intercepts one side of the loop before the other, causing a phase difference between the sides.

The phase difference produces incomplete cancellation, leaving a small residual voltage. This voltage *leads* or *lags* the space signal voltage, depending on the direction to or from the station. Fig. 5-b shows the loop signal when the loop is reversed.

Thus, breaking down the operation of the loop into its two component voltages, there is the *sense* voltage, which is the same no matter how the loop is held since it is the *omnidirectional* component of the antenna. And there is the *loop* voltage whose output depends directly upon the direction of the loop with reference to the direction of the signal. Both these voltages are developed across L_2 .

The addition and subtraction of *sense* and *loop* voltages are demonstrated graphically in Fig. 6. The sense voltage is the same, regardless of loop direction.

It is shown at *a* as a circle surrounding the antenna, with all voltages the same around the circle (shown *positive* in all directions around the antenna).

Loop voltage *b* is shown as a figure-8 pattern with resultant positive voltage toward the transmitter (at this instant) and with negative voltage in the opposite direction. Since the two voltages are received simultaneously, they are superimposed as in *c*. Adding the positive voltages will make that lobe larger. At the bottom of the pattern the voltages will oppose, cancelling that lobe completely. The resultant pattern *d* is called *cardioid* (shaped like a heart), with maximum response toward the station.



with **UTICA**[®]
"Cushion Throat" Pliers

Here's a simple and effective way to control cut ends of wire—keep them from flying or falling into a chassis.

The UTICA[®] "Cushion Throat" is a tough, rubbery red plastisol coating bonded right beside the cutting edge of UTICA[®] pliers. As the pliers close, the cushion grips the short end of wire and holds it tightly.

The "Cushion Throat" is specially valuable in electronics work—makes it possible to cut inside chassis without danger of wire snips causing a short. Grips spring or hard wire, too—gives extra safety on every cutting job!

Order from your distributor, today!

Only \$1 list additional—applied to most UTICA diagonal or side-cutting pliers.

Exclusive UTICA Patent.



UTICA (when referring to hand tools) is a trade mark registered in the U. S. Patent Office.

RADIO

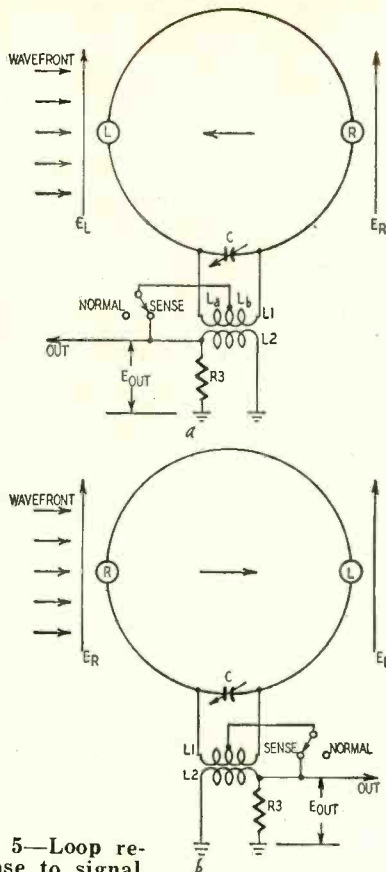

Fig. 5—Loop response to signal.

The loop has an arrow marked on the cross-piece to conform to the balance of the circuit so it points toward the source of the signal when the sensed output is maximum. The operator merely looks at the arrow to determine the direction of the transmitter when he sets the loop in position to give him loudest signal.

The analysis of directon finding was made with the attenuator (Fig. 1) in position 1. Since there are four attenuator positions, it may be useful to study operation in each. Fig. 7 shows the four attenuation positions.

At *a* we find the circuit previously described. Attenuation resistor *R* is 100 ohms. Series inductance *L* represents the inductance of connecting leads from coil to switch and transmission line. It combines with the inductance of *L2* (making but slight change in position 1), growing in importance at the greater attenuation positions.

At *b* attenuation position 2 intro-

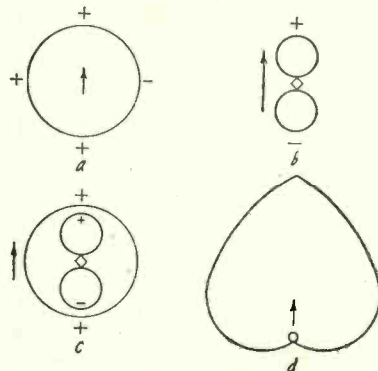

Fig. 6—Resultant response pattern.

duces a 22-ohm resistor in parallel with the 100-ohm resistor, reducing the amplitude of output fed to the receiver.

At *c* attenuation position 3 introduces a 47-ohm resistance in series with the 100-ohm resistor, making a voltage divider. The output is taken off the 100-ohm section. The high side of the coil is grounded to reduce further the amplitude of output fed to the receiver. Stray inductance is sufficient to prevent completely shorting *L2* in position 3 and some energy is passed on to the output terminals.

At *d* position 4 introduces the most extreme attenuation possible. The high side of *L2* was grounded to reduce output. Finding that enough signal was coupled to the output to destroy sensing at close quarters, the transmission line was cut open. Now the attenuation was correct. Enough signal was coupled by radiation to the output to permit proper sensing.

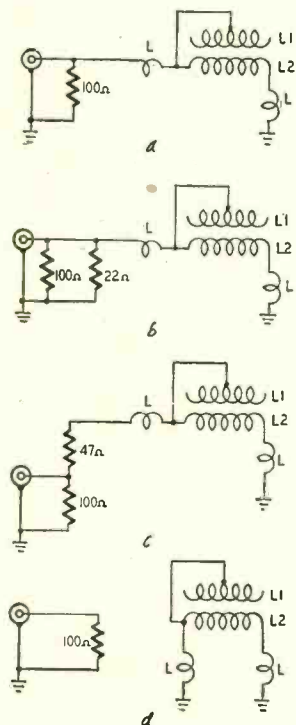

Fig. 7—Operation of the loop antenna in the various attenuator positions.

Remember the inductance of the coil leads to ground and you will avoid confusion in analysis of the circuit of Fig. 1 when you see that the top and bottom of the coil are grounded.

This loop is very popular because of its simplicity and effectiveness in the field. Construction experimenters may duplicate the circuit for ham and other uses by changing the size and number of turns in the loop to suit the frequency desired.

Readers will no doubt recognize this direction-finding system as the one used in the SCR-536 Handie-Talkie made famous during World War II and now being used by some hams and fire, police and emergency forces. The SCR-536 was described in detail in "Inside the Handie-Talkie" in the July, 1946, issue of RADIO-CRAFT.

END

**AS MODERN
AS TOMORROW...**

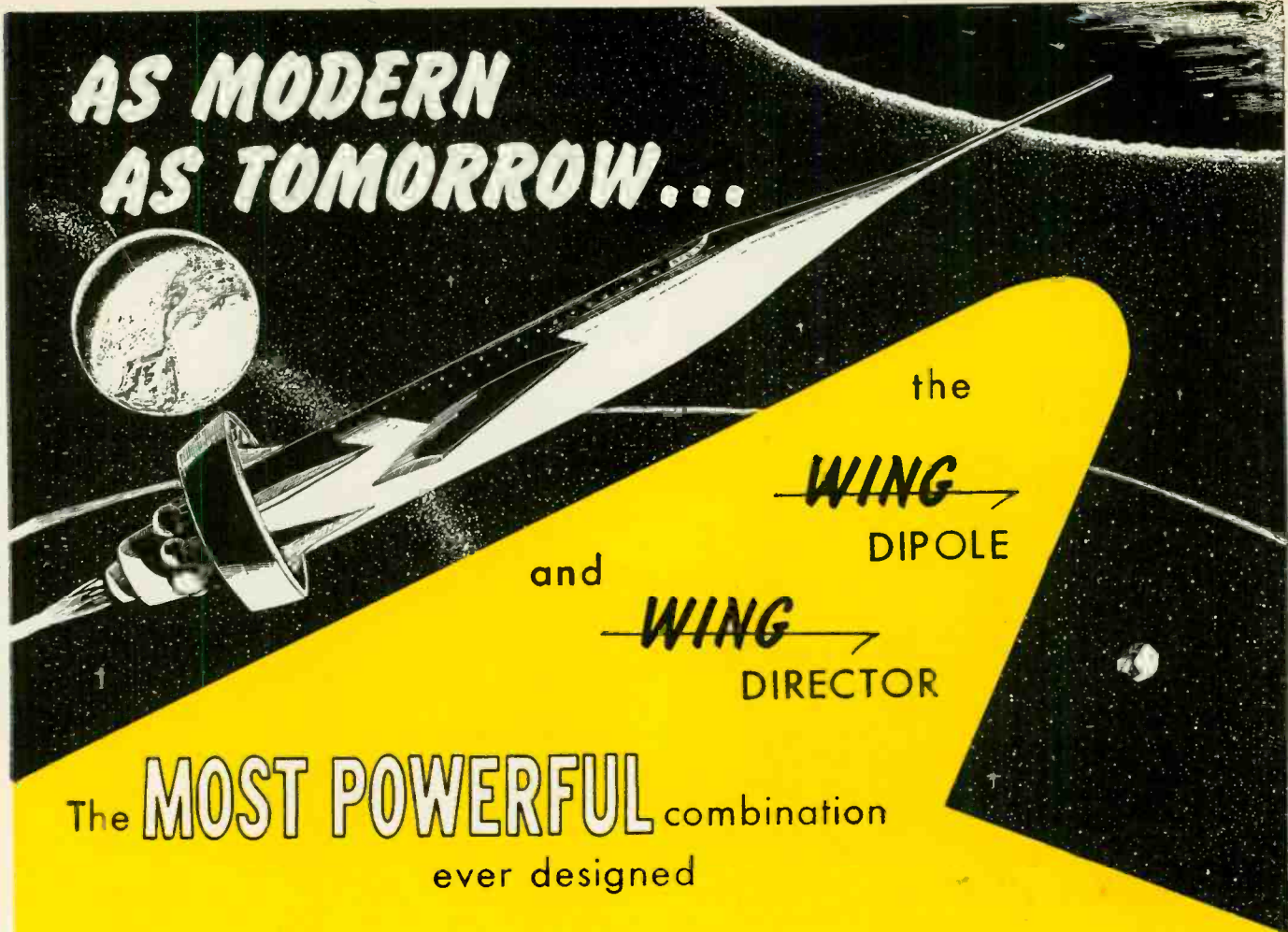

the

WING
DIPOLE

and

WING
DIRECTOR

The **MOST POWERFUL** combination
ever designed

FOUND ONLY IN THE TRIO ZEPHYR LINE

**ZEPHYR
MITE**

POWER PACKED PAIR



FOR DISTANCE

Zephyr

POWER PACKED THREESOME



FOR EXTREME DISTANCE

ZEPHYR ROYAL

POWER PACKED FOURSOME



FOR THE MAXIMUM

Trio's Zephyr and Zephyr Royal, the leaders of the 1956 season, are brought to you in the 1957 models improved and perfected, and destined to remain the champions. This famous antenna family is expanded by the Zephyr-Mite, newest addition to the Zephyr family. Trio's Zephyr family features the "Wing" dipole—the composite dipole that brought the power of the Yagi to every channel! Add to this the "Wing" director, the revolutionary new director specifically

designed to enhance the power and sensitivity of the "Wing" dipole—and you have a combination that is unequalled in the TV antenna field today for the maximum in performance. The "Wing" dipole and "Wing" director are exclusive features of the Trio Zephyrs—features that make Trio "the choice antenna line."

Trio's recognized quality construction features the internationally famous Insta-Lok clamps—the clamps that 'protect' the element!

TRIO[®]

Manufacturing Company
GRIGGSVILLE, ILLINOIS

COPYRIGHT 1956 TRIO MFG. CO. EXPORT SALES DIV., SCHEEL INTERNATIONAL INC., 4837 N. Lincoln Ave., Chicago, U.S.A. Cable Address: HARSHEEL

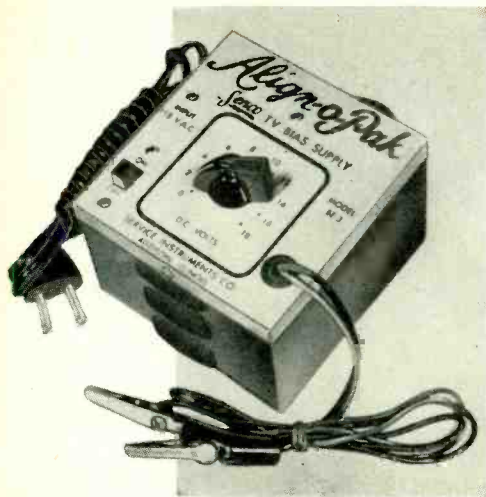

A commercial TV bias supply, made by Senco.

AGC in TV alignment

The effect of agc on receiver performance and during servicing; the bias box

By ROBERT BAUM* and HERB BOWDEN*

WHY is agc required? Manufacturers must build a television receiver with a sensitivity figure great enough to amplify TV signals as low as 5 to 10 microvolts. At this point the front-end noise is as great as the TV signal and it is useless to make the set any more sensitive. The same set must be used in areas where the signal will measure 50,000 microvolts and higher. The result (if receiver gain is left constant) is receiver overloading and sync clipping, causing loss of picture synchronization or no picture at all.

Thus, a circuit is needed to control receiver sensitivity in accordance with input signal strength so that the video amplitude will remain constant regardless of input level. This is the function of the agc circuit.

In early-model TV sets receiver sensitivity was controlled by the viewer with the *contrast* control, which varied the bias on the grids of the rf and first two if amplifiers. This system was satisfactory in strong-signal areas. In areas where signals were weak and signal fading was common, it became apparent that an automatic device was necessary—one that would increase the bias as the signal became stronger and reduce it with weaker signals. This bias, of course, could be obtained from the signal itself by sampling it at some appropriate point in the receiver.

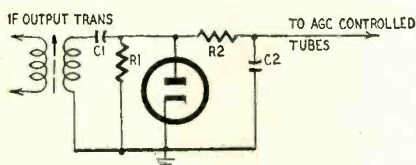

Fig. 1—A simple agc circuit

A simple agc circuit is shown in Fig. 1. It rectifies the incoming intermediate-frequency television signal and develops a negative pulsating dc volt-

age across resistor R1. Resistor R2 and capacitor C2 filter these pulses to essentially dc. Time constant R1 and C1 is generally 10 or more times the period of the horizontal synchronizing pulses to insure that C1 will stay charged to nearly the peak level of the sync pulse. In this respect the circuit is actually a peak-reading device commonly found in a vtm that reads peak-to-peak voltages. This simple circuit is employed in many low-cost TV receivers today and works satisfactorily.

A peak-reading agc system is essential in TV receivers since the agc voltage developed must vary directly with signal strength. If the system were an averaging device the agc voltage would vary with the video signal content and as the scenes became darker, the agc voltage would increase. A good example of this would be a man with a big black coat coming on stage. The agc voltage would increase and the video level decrease. The sound output in intercarrier sets would also decrease and the result would be less sound. Therefore, the man with the darkest coat has the weakest voice. Naturally this does not make sense. It becomes apparent that the system used must work from the sync pulse tips as they do not vary with background illumination.

The simple circuit shown in Fig. 1 operates on sync pulse tips but has one serious shortcoming—it will read all noise-pulse peaks as well. In very weak-signal, noisy areas, this results in agc voltage disproportionate to the signal level. The result is even weaker video. The receivers will have low sensitivity and poor sync stability.

To counteract this low sensitivity and instability, some manufacturers have modified the simple circuit shown in Fig. 1 to that shown in Fig. 2. The only difference is that a 10-megohm potentiometer has been added and R1 is lower in value. The 10-megohm control, often called a threshold control or range

finder, permits changing the circuit time constant to convert the detector from a peak-reading device to more of an averaging device. This makes the receiver less sensitive to noise pulses.

A superior type of agc circuit is shown in Fig. 3. This is called gated

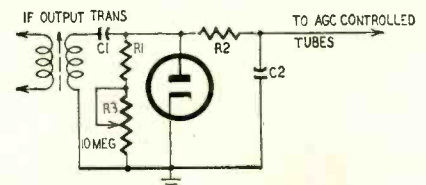

Fig. 2—A modified agc circuit.

or keyed agc. The circuit consists of a 6AU6 coincidence amplifier which conducts only during the presence of plate and grid signals. The plate voltage is supplied by a 300-500-volt (peak-to-peak) flyback pulse from the horizontal output transformer and the grid drive is the amplified video signal. When the televised picture is in sync, the horizontal sync pulses and flyback pulses occur at the same time, causing the tube to conduct. However, conduction occurs only at the sync-pulse level because of the negative bias developed across R1 by the video amplifier plate current.

The principal advantage of this system is that noise pulses occurring between sync pulses will not produce agc voltage as the tube has no plate voltage. Also, since the agc voltage is essentially amplified, it provides a faster-acting system that is less apt to overload.

Alignment and agc

The effect of operating the agc system during alignment is obvious when all facts are considered. Let's examine the average sweep generator used for television alignment. This is an instrument that produces FM in the appropriate ranges for television work. The output of the generator is frequency-

* Service Instruments Co., Addison, Ill.

PROTECT YOUR REPUTATION!

Cut price TV tuners are surplus from a special run of a special design for one particular model of one particular manufacturer. Chances are overwhelmingly against your ever being able to use a surplus tuner properly—in the set for which it was designed. PROTECT YOUR REPUTATION—don't force match a "bargain" tuner to your customer's set—use only STANDARD APPROVED REPLACEMENT TUNERS (which are furnished you complete with schematic). These will cover over 90% of your service replacement needs. Designed exclusively for service by the manufacturer of more than 19,000,000 TV tuners in use today.

Tell the Customer

“ You should have a STANDARD APPROVED REPLACEMENT TUNER FOR UHF (ultra-high frequency) STATIONS. Often the older and larger stations known as VHF STATIONS (very high frequency) are too far away to give top quality pictures. The STANDARD APPROVED REPLACEMENT TUNER is the tuner specially built for UHF conversion. It will accommodate any of the 70 UHF TV Channels! UHF strips can be put into your tuner any time, and because it is so easy for the serviceman, it will cost less in service charges.”

At your jobs in factory-sealed packages only.

Master
Specialists
in
Tuned Circuits

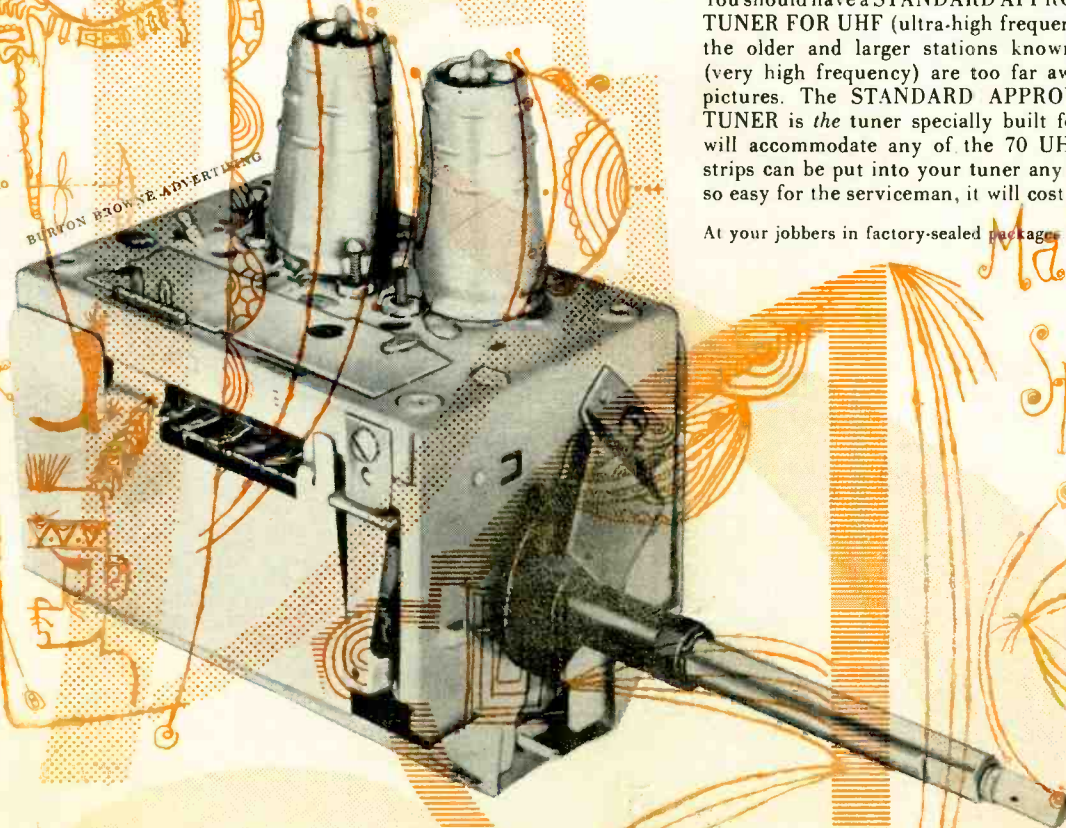

Standard COIL PRODUCTS CO., INC.

CHICAGO—LOS ANGELES—BANGOR, MICH.—NO. DIGHTON, MASS.

Export Agent: Scheel International, Inc., Chicago

ORIGINATORS of the Turret Style Tuner
ORIGINATORS of the Standard Cascade Tuner
ORIGINATORS of the Standard Pentode Tuner
ORIGINATORS of the New Neutrade Tuner

Master Specialists in Tuned Circuits
World's Largest Manufacturer of Electronic Components

TELEVISION

modulated with a 60-cycle sine wave. This same 60-cycle wave drives the horizontal deflection plates of the oscilloscope to insure perfect synchronization when viewing the response curve of the TV receiver. Since the retrace sweep on the oscilloscope is visible with sine-wave deflection, two superimposed amplifier response curves would appear on the scope. These are not often perfectly superimposed, and for this reason the output of the sweep generator is often blanked out for half of the 60-cycle period to permit indication of only one response curve. However, it is this blanking of the sweep generator output that causes alignment inaccuracies when the agc circuit is permitted to operate.

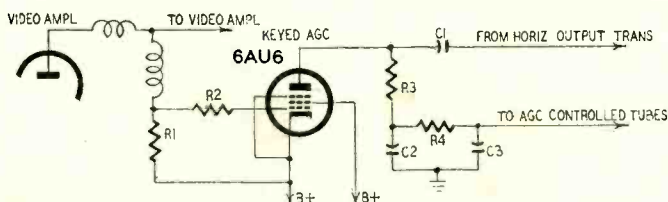

Fig. 3—The basic gated agc circuit.

The filter system of the agc circuit must have an R-C time constant large enough to filter the 15,750-cycle sync pulses to dc but still short enough to follow changes in signal strength within several frames. During alignment, the signal from the sweep generator is present only half of the time. Thus the agc filter will charge and discharge over the 60-cycle period to follow the presence and absence of signal. The result on the agc line is a voltage waveform similar to that shown in Fig. 4.

When this voltage waveform is applied to the grids of the agc-controlled tubes, it biases the amplifiers more on one side of the sweep than on the other and results in a response curve similar to that shown by the dotted lines in Fig. 5. (This effect is greater with a gated agc circuit than with those which are not because of the inherent amplification of the agc voltage in this type circuit.)

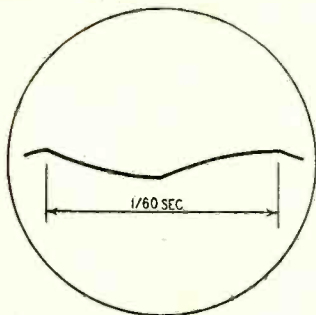

Fig. 4—Voltage waveform on agc line when sweep generator is used.

When the service technician sees the improper curve on the oscilloscope, he naturally thinks that the if amplifier tuning slugs need touching up and often goes ahead, actually misadjusting the receiver. If an external fixed dc bias is applied to the agc line, the curve will appear normal without adjustment.

Thus, a set cannot be aligned accurately when the agc circuit is permitted to operate. Merely disconnecting the agc circuit will not do since the agc voltage developed under actual operating conditions may vary from zero (except for contact potential) to as high as 12 volts. What then should the bias be?

Manufacturers determine an average potential and recommend that this be used for all alignment. For example in late Admiral receivers 4.5 volts is suggested, in Motorola 3 volts, in Zenith 2 volts variable and in Philco 7.5 volts, just to name a few. The importance of using the correct bias can be seen by the fact that the response curve will change considerably in most receivers when the

dc bias is varied from 0.5 to 10 volts. As a matter of fact, the response curve becomes a single peak (at low bias setting) in some late-model high-gain receivers. This is due mainly to two things: Miller effect and regeneration. Miller effect is the detuning of circuits caused by changes in tube interelectrode capacitance with applied bias. Regeneration is usually caused by a feedback path from the third if amplifier to the first. Little can be done about either after the set has been

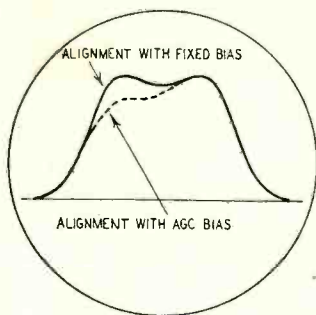

Fig. 5—Variations in if amplifier response with changes in agc bias.

designed and in the field. Most of us have been confronted with sets that seem to be good on strong signal but have poor picture detail on weak signals and vice versa.

If a receiver is to be used in areas with both strong and weak signals, the only answer is to align it with the bias recommended by the manufacturer and then vary the bias from around 1 to about 7 volts to be sure that the curve does not change considerably. If, however, the receiver is to be used only in weak-signal areas, it should be aligned with a potential of around 1 to 2 volts, as this is all that will be developed during operation. For best accuracy, it is a good idea to measure the agc bias with a signal coming in

and use that bias. (Or an average of several stations' bias, if all are nearly the same strength.)

Agc troubleshooting

A dc bias can also be used to determine quickly if there is trouble in the agc circuit. If the agc in a television receiver becomes defective, it means that either not enough or too much agc voltage is being developed. These troubles can really be a headache unless it is determined immediately whether the agc line is at fault. To do this, merely connect a dc bias supply to the agc line (without disconnecting any leads in the TV receiver) and slowly vary the bias. If the picture

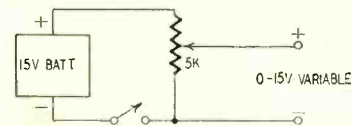

Fig. 6—Simple dc voltage supply.

stabilizes and the picture contrast is correct, the agc circuit is at fault.

Several methods of providing the necessary dc bias are available. The simplest way, of course, is to buy a dry-cell battery. The difficulty that arises here is that TV manufacturers recommend voltages from +2 volts to -12. A simple circuit, shown in Fig. 6, can be constructed to provide these voltages. The output can be calibrated and a steady dc 15-volt supply is available. However, with this circuit the

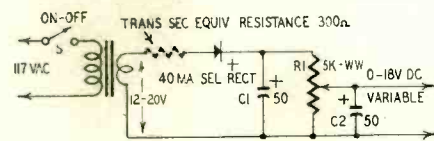

Fig. 7—A commercial bias supply.

batteries eventually have to be replaced and the system would cost about as much as the electronic one of Fig. 6.

This electronic system is a simple isolated power supply with heavy filtering. This is the circuit of the commercially available supply shown in the photo. A wirewound potentiometer is used to obtain linear calibration and to insure calibration accuracy. A 40-ma selenium rectifier is used. If the output leads become shorted, the supply will not become defective. This protection is provided by the 300-ohm internal resistance of the special transformer secondary.

The transformer shown in Fig. 6 could be eliminated and the rectifier hooked onto the 6.3-volt heater supply of the television receiver. However, to say nothing of the time wasted connecting the supply, a number of new receivers do not have the 6.3-volt heater windings, but rather have series heaters. Naturally the supply without the transformer could not be used.

Thus, to avoid alignment inaccuracies, disable the agc circuit by substituting the dc bias recommended by the set manufacturer. In this way the television set can be aligned faster and with much greater accuracy. **END**

you get the most for your money in
ALLIED'S own knight-kits

THE FINEST ELECTRONIC EQUIPMENT IN MONEY-SAVING KIT FORM

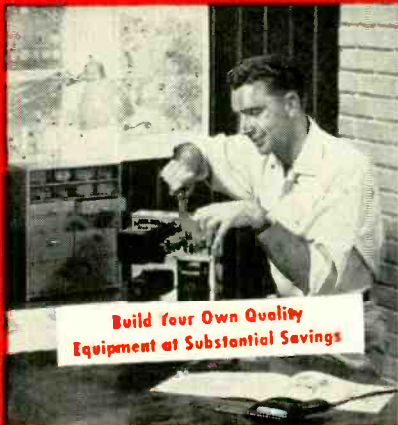

Buy With Confidence From the Pioneers in Electronic Kits

LOWEST COST—our huge buying power means biggest savings for you. You do the easy assembly and your finished instrument is equal in performance and appearance to equipment selling for several times the remarkably low KNIGHT-KIT price.

ADVANCED DESIGN—months of research, development and field-testing go into each KNIGHT-KIT to bring you the latest advances in quality design. And to assure top performance, premium quality parts are supplied in each kit.

EASIEST TO ASSEMBLE—all chassis and panels are punched; all parts are clearly identified—resistors are mounted on cards and values are shown. Instruction manuals are a marvel of clarity, featuring "Step-and-Chek" assembly, "King-Size" diagrams and "Spotlight" pictorials. All you need are soldering iron, pliers and screwdriver.

ALLIED stakes its 36-year reputation in the Electronics field on your complete success and fullest satisfaction with KNIGHT-KITS.

TEST EQUIPMENT • HAM GEAR • HOBBYIST KITS • HI-FI KITS



LATEST PRINTED CIRCUIT

NEW knight-kit LOW COST GENERAL-PURPOSE 5" OSCILLOSCOPE KIT

Model F-146

\$49⁵⁰

Outstanding value in an all-new, highly versatile 5" oscilloscope kit. Perfect for visual display of all commonly encountered waveforms. Excellent for AM, FM and TV servicing, plus other high-frequency applications. An easy-to-build, easy-to-use, dependable performer that matches or beats commercially wired scopes selling at several times more. Up-to-the-minute kit design features printed circuit, laced wiring harness, and pre-cut wires for quick and easy assembly. Has 4 sweep ranges, 15-150,000 cps. High vertical sensitivity: 25 rms millivolts/inch; input impedance, 3.3 megs and 45 mmf; response down only 3 db at 700 kc. Horizontal sensitivity, 70 rms mv/inch; response, down only 3 db at 200 kc; input impedance, 2.2 megs and 30 mmf. Deluxe features include DC positioning controls for fast trace positioning; blanking circuit on all ranges to eliminate retrace lines; graph scope screen and internal, regulated calibrating voltage for highly accurate signal measurements; frequency-compensated vertical attenuator; provision for internal or external, positive or negative synchronization; Phantastron linear sweep generator; high 2nd anode voltage for high-intensity trace. Kit is complete with 5" CRT and all tubes—ready for assembly. Blue steel case with "disappearing" handle. Handsome panel in contrasting gray. Size, 14½ x 9½ x 16" deep. Shpg. wt., 40 lbs.

- Model F-146. Complete 5" Oscilloscope Kit. Net only..... **\$49.50**
- F-148. RF Demodulator Probe Kit. Net only..... **\$3.45**
- F-147. Low-Capacity Probe Kit..... **\$3.45**

EASY PAYMENT TERMS

If your total KNIGHT-KIT order is over \$45, take advantage of our liberal Time Payment Plan—only 10% down. Write for application form.



Model F-123

\$44⁷⁵

NEW knight-kit TV-FM SWEEP GENERATOR KIT

Guaranteed Linearity • Fool-proof Calibration
 Wide-Range Coverage • Electronic Blanking

All-new; precision-designed for lab use, TV and FM servicing, production line testing. Covers 300 kc to 250 mc continuous on 4 bands (all fundamentals). Center frequencies of VHF TV channels appear on scales. Exclusive KNIGHT-KIT sweep circuit assures almost perfect linearity—RF sweep output in excess of 0.15 volts, flat within 1 db, is available on all bands. Sweep width continuously variable, 0-13 mc. Crystal-controlled marker oscillator with dual crystal socket and selector switch. Phase control provides blanking shift, 0 to 180°. Step-type and continuous output controls; separate marker amplitude control. Filter connected to 0-50 mc output jack provides 20 db attenuation of frequencies above 50 mc. to assure pure, fundamental output. 5-volt horizontal sweep voltage (for scope) available from front panel. Professional-looking blue-finish steel case with gray panel. Has "disappearing" handle. 8½ x 12 x 7½". With all parts, tubes, test cable, solder and multi-color pre-cut wire. Less crystal. Shpg. wt., 13½ lbs.

- Model F-123. TV-FM Sweep Generator Kit. Net only..... **\$44.75**
- P-286. 4.5 mc Crystal (.005%). Net..... **\$4.80**
- P-143. 5.0 mc Crystal (.02%). Net..... **\$3.95**
- P-145. 10.7 mc Crystal (.02%). Net..... **\$3.95**

ALL PRICES NET F.O.B. CHICAGO

order from **ALLIED RADIO**

100 N. WESTERN AVE., CHICAGO 80, ILLINOIS

SEE FOLLOWING PAGES

ALLIED'S own knight-kits... better by far



knight-kit 5" ALL-PURPOSE WIDE-BAND OSCILLOSCOPE KIT

2 Printed Circuit Boards • 5 Mc Width for Color TV

Model F-144

\$69⁰⁰

Wide-band, 5" Oscilloscope; equals or betters the performance of commercially-wired 'scopes costing several times the price. Two printed circuit boards and laced wiring harness assure wiring accuracy and reduce assembly time. Ideal for lab use, color TV servicing and high frequency applications. Provides unusually wide sweep range—from 15 to 600,000 cps. Locks in at frequencies as high as 9 mc. Vertical response, 5 cycles to 5 mc. Response, down only 1 db at 3.58 mc color burst frequency; down only 3 db at 5 mc. High vertical sensitivity of 25 mv/inch. Input capacity 20 mmf and 3.5 megs. Outstanding features: cathode-follower vertical and horizontal inputs; 2nd anode provides 1400 volts high-intensity trace; push-pull vertical and horizontal amplifiers; positive and negative locking; faithful square wave response; frequency-compensated attenuator; Z-axis input for intensity modulation; one volt P-P calibrating voltage; astigmatism control; blanking circuit to eliminate retrace lines; DC positioning control. Complete with CRT, all tubes and parts. Handsome, professional, blue-finished steel case with "disappearing" handles. 14½ x 9½ x 16". Shpg. wt., 40 lbs.

Model F-144. Wide-Band 5" Oscilloscope Kit. Net only... **\$69.00**
 F-148. Demodulator Probe. Net... \$3.45. F-147. Low Capacity Probe. 12 mmf. Net... \$3.45

NEW knight-kit VOLTAGE CALIBRATOR KIT

Model F-136 **\$12⁷⁵**



Permits the use of any scope as a precision peak-to-peak AC voltmeter. Provides a true square-wave voltage on scope screen. Range switch and calibrated potentiometer permit selecting any voltage between .01 and 100 volts, in 4 ranges. Fifth position of switch feeds external signal to scope for comparison. Constant output on line volt. variation from 80-135 v. ±6% on all ranges. Shunt capacitance only 15 mmf. Use any 20,000 ohms/volt VOM or a VTVM for initial calibration. Direct coupling of output provides ground reference for DC scopes. Portable case, 7¾ x 5¼ x 4¾". Ready to build. Shpg. wt., 5 lbs.

Model F-136. Voltage Calibrator Kit. Net... **\$12.75**



knight-kit LOW COST RF SIGNAL GENERATOR KIT

Model F-145 **\$19⁷⁵**

Build this wide-range extremely stable RF signal generator and save two-thirds the cost of a comparable wired instrument. Ideal for alignment of RF and IF stages in radio and TV sets, and for troubleshooting audio equipment. Delivers output on fundamentals from 160 kc all the way out to 110 mc; useful harmonics to 220 mc. Has built-in 400-cycle sine-wave audio oscillator for modulating RF; audio is also available externally. Features high-stability Colpitts circuit with precision-wound coils—no calibration necessary. Has input for external modulator. Maximum audio output, 10 volts. RF output, over 100,000 micro-volts. Step and continuous-type output attenuators. With all parts, tubes, wire and solder. Portable case, 7 x 10 x 5". Shpg. wt., 10 lbs.

Model F-145. RF Signal Generator Kit. Net only... **\$19.75**



Model F-135 **\$26⁵⁰**

knight-kit VISUAL-AURAL SIGNAL TRACER KIT

A remarkable value in an instrument which permits visual and aural signal tracing of RF, IF, video and audio circuits—has highest gain in its price class. Traces the signal from the antenna to the speaker. Reproduces signal at plate or grid connection of any stage. Identifies and isolates "dead" stages. Features: usable gain of 91,000; "magic eye" with calibrated attenuators for signal presence indication and stage-by-stage gain measurements; built-in 4" PM speaker; single probe with plug-in head gives instant choice of RF or audio tracing. Provides noise test; built-in watt meter calibrated from 25 to 1000 watts; provision for external scope or VTVM. Blue-finish steel case. Shpg. wt., 13 lbs.

Model F-135. Signal Tracer Kit. Net only... **\$26.50**



Model F-129 **\$37⁹⁵**

NEW knight-kit 6-12 VOLT BATTERY ELIMINATOR KIT

A valuable new unit for servicing auto radios, mobile gear, etc. Delivers continuously variable filtered DC output from 0 to 15 volts. Provides DC output at 0-8 volts or 0-15 volts. Continuous current rating: 12.5 amps at 6 volts, 10 amps at 12 volts. Can also be used as battery charger. Oversize rectifiers and transformer for better regulation and long life. Two meters provide simultaneous current and voltage readings; ranges: 0-15 volts DC; 0-20 amps DC. Doubly protected: fused primary and automatic-reset overload relay for secondary. Heavy-duty binding posts. Blue-finish steel case with "disappearing" handle. With all parts, solder and pre-cut wire. 9 x 12¼ x 7¾". Shpg. wt., 20 lbs.

Model F-129. Power Supply Kit. Net only... **\$37.95**



knight-kit AUDIO GENERATOR KIT

Model F-137 **\$37⁵⁰**

An ideal audio frequency source for checking audio circuits and speaker response. Covers: 20 cps to 1 mc in 5 ranges. Output voltage: 10 volts into 600 ohms impedance. Offers the flat response of a lab standard—±1 db to 1 meg. Generator imp., 600 ohms. Less than .25% distortion from 100 cps through the audible range; less than .5% when driving 600 ohm load at maximum output. Cont. var. step-attenuated output. 17 lbs.

Model F-137. Audio Generator Kit. Net only... **\$37.50**

knight-kit RESISTANCE SUBSTITUTION BOX KIT

Model F-139 **\$5⁹⁵**



Simplifies determination of resistor values needed in a circuit. 36 standard 1 watt resistance values between 15 ohms and 10 megohms with an accuracy of 10%. 18-position switch; also slide switch for multiplying values by 1000. Extra switch wafer serves as tie points, eliminating buss bar. 5 x 3 x 2". Complete with test leads and clips. 2 lbs.

Model F-139. Resis. Sub. Box Kit. Net... **\$5.95**

knight-kit CAPACITANCE SUBSTITUTION BOX KIT

Model F-138 **\$5⁹⁵**



Makes it easy to find capacitor values needed in a circuit. Provides 18 standard capacitor values from .0001 mfd. to .22 mfd., ±20%. Values are 600 volts, except .15 and .22 which are 400 volt. 18-position switch selects all values quickly and easily. In bakelite case, 5 x 3 x 2". Complete with all parts, test leads and clips. 2 lbs.

Model F-138. Cap. Sub. Box Kit. Net... **\$5.95**

QUALITY ELECTRONIC TEST EQUIPMENT IN MONEY-SAVING KIT FORM

... easiest to build ... you get more ... YOU SAVE MORE

4 1/2" Meter



Model F-128 \$16.95

**knight-kit
1000 OHMS/VOLT VOM KIT**

Exceptional accuracy and versatility at amazing low cost. Ideal for service shop, lab and Amateur use. Uses 4 1/2" meter (400 microamp movement) with separate scales for AC voltage and current, DC voltage and current, decibels and resistance. 38 ranges include: AC, DC and output volts, 0-1-5-10-50-100-500-5000 (1000 ohms/volt sensitivity); Resistance, 0-1000-100,000 ohms and 0-1 meg.; Current, AC or DC, 0-1-10-100 ma and 0-1 amps; Decibels, -20 to +69 in 6 ranges. Uses 1% precision resistors. 3-position function switch and 12-position range switch. Complete kit with bakelite case, (6 3/4 x 5 1/4 x 3 3/4"), battery, pre-cut wire, solder and test leads. Shpg. wt., 2 1/2 lbs.

Model F-128. 1,000 ohms/volt VOM Kit. Net only \$16.95



Model F-140 \$29.50

**knight-kit
20,000 OHMS/VOLT VOM KIT**

Outstanding quality and performance at extremely low cost. Features 32 ranges; full vision 4 1/2" meter; accuracy ±2% of full scale; 50 microampere sensitivity for 20,000 ohms/volt input resistance on DC; front panel "zero adjust" Single switch selects function and range. Range: AC, DC and output volts, 0-2.5, 10-50-250-1000-5000; Resistance, 0-2000-200,000 ohms and 0-20 meg.; DC ma, 0-1-10-100; DC amps, 0-1-10; Decibels, -30 to +63 in 6 ranges. Uses precision 1% multipliers. Moisture-resistant film-type resistors. Complete kit with bakelite case (6 3/4 x 5 1/4 x 3 3/4"), batteries, pre-cut wire, solder and test leads. Shpg. wt., 5 lbs.

Model F-140. 20,000 ohms/volt VOM Kit. Net only \$29.50



knight-kit RESISTOR-CAPACITOR TESTER KIT

Model F-124 Measures capacitance and resistance by accurate bridge method; checks for opens and shorts in paper, mica and ceramic capacitors; shows power factor of electrolytics. Large dial shows capacitance and

resistance at a glance; balanced-bridge circuit with "magic eye" null indicator measures power factor from 0-50%. Tests capacitors with rated voltages applied. 5 test voltages: 50, 150, 250, 350, 450. Capacity ranges: 10 mmf to 1000 mfd in 5 ranges. Resistance ranges: 100 to 50,000 ohms and 10,000 ohms to 5 megs. Accuracy, ±10%. Automatic discharge feature prevents after-test shock. Blue-finished steel case, 5 x 3 x 2". With tubes and all parts. Shpg. wt., 8 lbs.

Model F-124. Resistor-Capacitor Tester Kit. Net only \$19.50



NEW knight-kit TRANSISTOR & DIODE CHECKER KIT

Model F-149 \$8.50 Checks leakage-to-gain ratio and noise level of all junction, point contact and barrier transistors. Also checks diodes, forward and reverse current conduction of selenium rectifiers; useful for continuity and short checks. Easy-to-read meter. Features: spring-return leakage gain switch; calibration control; separate sockets for PNP and NPN transistors. Headphones or signal tracer may be used with checker for noise measurements. Case, 5 x 3 x 2". With 22 1/2 volt battery. 2 1/2 lbs.

Model F-149. Transistor Checker Kit. Net \$8.50

EASY PAYMENT TERMS: If your total KNIGHT-KIT order is over \$45, take advantage of our liberal Time Payment Plan —only 10% down. Write for application blank.

ALL PRICES NET F.O.B. CHICAGO



knight-kit VTVM KIT with Printed Circuit Board

Model F-125 An extremely stable, and highly accurate VTVM. Greatly simplified wiring—entire chassis is a printed circuit board. Maximum convenience in arrangement of scales; 3X AC and DC scale design permits utilization of best portion of each scale for most accurate readings. Also measures peak-to-peak for FM and TV work. Ranges: AC P-P volts, 0-4-14-40-140-400-1400-4000; AC rms volts and DC volts, 0-1.5-5-15-50-150-500-1500; resistance, 0-1000-10K-100K ohms and 0-1-10-100-1000 megohms; db scale, -10 to +5. AC response, 30 cycles to 3 mc. Low-leakage switches and 1% precision resistors. Balanced-bridge circuit. 4 1/2" meter, 200 microamp movement. Polarity reversing switch. Input res., 11 megs. Shpg. wt., 6 lbs.

\$24.95

Model F-125 Printed Circuit VTVM Kit. Net only \$24.95
F-126. Hi-Voltage Probe; extends DC to 50,000 Volts \$4.75
F-127. Hi-Frequency Probe; extends AC to 250 mc. \$3.45



Model F-143 knight-kit LOW-COST TUBE TESTER KIT

Model F-143 \$29.75 Offers high accuracy, top versatility and convenience at lowest cost. Tests 4, 5, 6 and 7-pin large, regular and miniature types, octals, loctals, 9-pin miniatures and pilot lamps. Features test for new 600 ma series string tubes. Tests for open, short, leakage, heater continuity and quality (by amount of cathode emission). 4 1/2" square meter with clear "GOOD?-REPLACE" scale. With line-voltage indicator and line-adjust control. Choice of 14 filament voltages from .63 to 117 volts. Blank socket for future type tubes. Universal-type selector switches for any combination of pin connections. Single-unit, 10-lever function switch. Entire switch assembly is installed as a single unit—saves time and greatly simplifies construction. Illuminated roll chart lists over 600 tube types. Shpg. wt., 14 lbs.

Model F-143. Counter Model Tube Tester Kit. Net only \$29.75
Model F-142. Portable Model Tube Tester Kit. Net only \$34.75
F-141. TV Picture Tube Adapter for above. Net only \$3.75



PORTABLE MODEL



knight-kit LOW-COST "IN-CIRCUIT" CAPACITOR CHECKER KIT

Model F-119 \$12.50 Tests capacitors while they are still wired in the circuit! Saves time and bother; an essential instrument for the service technician. Just press a button and the "magic eye" instantly shows opens and shorts (not leakage). Tests opens and shorts on any capacitor of 20 mmf or greater capacity, even if it is in parallel with a resistance as low as 50 ohms. Tests for shorts may be made on any capacitor even when it is shunted by as low as 20 ohms. Blue-finish steel case, 7 3/4 x 5 1/4 x 5". With tubes, all parts, wire and solder. Easy to assemble. Shpg. wt., 5 lbs.

Model F-119. Cap. Checker Kit. \$12.50

order from **ALLIED RADIO** 100 N. WESTERN AVE., CHICAGO 80, ILL. →

ALLIED'S own MONEY-SAVING knight-kits

FAMOUS knight-kits FOR HOBBYISTS & EXPERIMENTERS... FASCINATING, INSTRUCTIVE...



knight-kit
"SPACE SPANNER"
BAND SWITCHING
RECEIVER KIT

Model S-243 **\$15⁹⁵**

Thrilling Short Wave and Broadcast

Famous 2-band AC-DC receiver in easy-to-build kit form at a very low price. Pulls in thrilling short-wave (6 to 17 mc) and standard broadcast. It's fun listening to amateur, aircraft, police and marine radio. Features highly sensitive regenerative circuit. Bandswitch selects broadcast or short wave. Has 4" PM speaker and beam-power output tube for plenty of volume; headphone connectors for weak signal listening; slide switch cuts out speaker. Uses 12AT7 regenerative detector and audio amplifier, 50C5 power output, 35W4 rectifier. Six controls: Bandsread; Main Tuning; Antenna Trimmer; Bandswitch; Regeneration; Audio Gain. Includes tubes and all parts. 7 x 10½ x 6". Shpg. wt. 4½ lbs.

Model S-243. "Space Spanner" Receiver Kit. Net only. . . . **\$15.95**
S-247. Matching Cabinet for above. 2 lbs. Net. . . . **\$2.90**



Model S-295 **\$14⁷⁵**

NEW knight-kit TWO-WAY INTERCOM KIT

New low-cost, easy to build intercom system kit. Ideal for use in home or office. Consists of Master unit and Remote unit, each with press-to-talk switch. Remote unit may be left "open" for answering calls from a distance, for "baby-sitting", etc. Remote may also be connected for "private" operation—cannot be "listened-in" on, but it can be called and can originate calls. Master unit includes high-gain 2-stage amplifier; each unit has 4" PM dynamic speaker. Complete with Antique White cabinets (4¾ x 6½ x 4¾"), all parts, tubes and 50 feet of cable (up to 200 feet of cable can be added). For AC or DC. Shpg. wt., 7 lbs.

Model S-295. Two-Way Intercom Kit. Net only. . . **\$14.75**

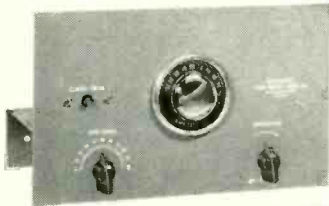

Model S-740 **\$11⁷⁵**

knight-kit

"OCEAN HOPPER" RECEIVER KIT

Tops for exciting broadcast, long wave and short wave reception. Highly sensitive regenerative-type circuit. Excellent headphone reception; can be used with 3-4 ohm PM speaker on strong broadcast band stations. Supplied with plug-in coil for standard broadcast; covers long wave and popular short wave bands with coils below. Pulls in thrilling foreign broadcasts, police, amateurs and aircraft. Controls: Main Tuning, Bandsread, Antenna Tuning, Off-On-Regeneration. With all parts and tubes (less extra coils and headset). AC or DC. Shpg. wt., 5 lbs.

Model S-740. "Ocean Hopper" Kit. . . . **\$11.75**

EXTRA PLUG-IN COILS

S-741. Long Wave, 155-470 kc. Net. . . . 79¢
S-742. Short Wave, 1.65-470 mc. }
S-743. Short Wave, 2.9-7.3 mc. } Net
S-745. Short Wave, 7-17.5 mc. } each. . . . 65¢
S-744. Short Wave, 15.5-35 mc. }



Model S-735 **\$17²⁵**

knight-kit

"RANGER II" SUPERHET RADIO KIT

Thousands have built and enjoyed the "Ranger" Broadcast Band Receiver. Carefully engineered for easy construction and powerful, sensitive performance. Latest Superhet circuit; tunes 540 to 1680 kc; covers entire broadcast band and exciting police calls. Features automatic volume control, built-in preformed loop antenna, ball-bearing tuning condenser. Develops excellent tone quality from Alnico V PM dynamic speaker. Supplied with following tubes: 12SA7GT converter; 12SK7GT IF amp.; 12SQ7GT det.-AVC-audio; 50L6GT audio output; 35Z5GT rect. Complete with handsome brown plastic cabinet (6 x 9 x 5) tubes, speaker, all parts, and instruction manual. AC or DC operation. Shpg. wt., 8 lbs.

Model S-735. "Ranger II" Superhet Radio Kit. Net only. . . . **\$17.25**



Model S-730 **\$19⁹⁵**

knight-kit

3-WAY PORTABLE RADIO KIT

A low-cost portable radio covering the full standard broadcast band from 535 kc to 1650 kc. Delivers excellent reception on AC or DC current or from self-contained batteries. Sensitive Superhet circuit features automatic volume control, economical operation. Includes powerful 5" Alnico PM dynamic speaker, efficient ferrite loop-stick antenna. Supplied with following tubes: 1R5 converter; 1U4 IF amplifier; 1U5 detector-AVC-audio; 3V4 audio output. Complete with attractive portable case (7¾ x 10 x 5¼"), tubes, speaker, all parts and instruction manual. Shpg. wt., 6 lbs.

Model S-730. 3-Way Portable Radio Kit (less batteries). Net. **\$19.95**
J-651. Battery Kit for above. . . . **\$2.50**

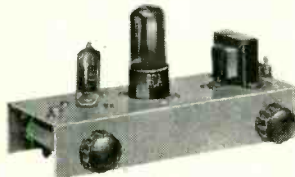

knight-kit LOW COST PHONO AMPLIFIER KIT

Model S-790 **\$8⁹⁵**

It's easy to build this fine-performing, low-cost compact phono amplifier. Ideal for use in a portable phono-graph—simply add any record player and a 3 to 4-ohm speaker. Amplifier works with crystal or ceramic cartridges. Inverse feedback circuit for rich, clean tone quality. Delivers full 1½-watt output with less than .25 volt input. Includes efficient tone control; has AC outlet, controlled from amplifier switch. Complete with tubes and all parts. Size only 4½ x 7 x 4"—fits into almost any portable phono case. Shpg. wt., 3 lbs.

Model S-790. Phono Amplifier Kit. Net only. . . . **\$8.95**

FAMOUS knight-kit CRYSTAL SET KIT

Model S-261

\$2¹⁵

Thousands of beginners have started in radio and electronics by building the KNIGHT-KIT crystal set. This feature-packed set delivers loud, clear reception of local broadcast stations. A germanium crystal diode detector assures high sensitivity and simple operation—no crystal adjustment required. "Hi-Q" coil boosts sensitivity. Ball-bearing variable capacitor for easy tuning. With all parts and simple-to-follow instructions. Shpg. wt., 1 lb.

Model S-261. Crystal Set Kit. Net only. . . . **\$2.15**
S-267. Accessory Kit. 2000-ohm headphones and all parts for outdoor antenna. . . . **\$2.95**



Buy with confidence from ALLIED — America's Pioneer in Electronic Kits

finest quality electronic equipment in lowest-cost kit form

EASY-TO-BUILD HIGH PERFORMANCE KITS • WIDELY USED BY MANY LEADING TRAINING SCHOOLS



NEW knight-kit ELECTRONIC PHOTOFLASH KIT

Model S-244
\$28.50

New feature-packed photoflash kit—designed for top quality dependability—available at a money-saving low price. Ideal for black and white or color photography. Xenon-filled reflector-bulb assembly gives over

10,000 flashes at less than 1/2¢ each! 1/700-second flash freezes the fastest action. Has 50 watt-second output. Provides light approximating daylight in spectral quality; permits the use of outdoor-type film indoors. Film guide number for color (ASA10) is 45. Designed for "X" or "O" shutters only. Requires sync cable (available from any photo supply dealer) and either battery or AC supply listed below. Complete outfit with battery weighs only 3 1/2 lbs. Kit includes all parts, carrying case and easy-to-follow instructions. Shpg. wt., 3 lbs.

Model S-244. Electronic Photoflash Kit. Net.... **\$28.50**
S-246. AC Power Supply Kit. Easy to assemble.... **\$3.75**
J-626. Battery for above (Burgess U-200)..... **\$8.47**

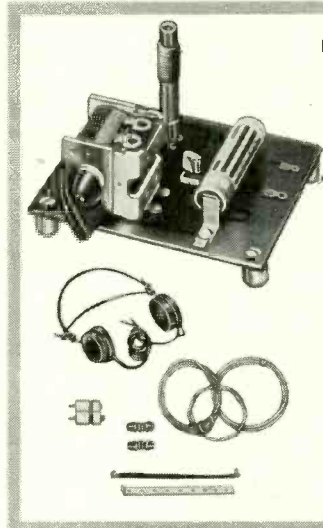

knight-kit TRANSISTOR RADIO KIT Printed Wiring • Works from Penlight Cell

Model S-765
\$4.35

Smooth Variable Capacitor Tuning

Experiment with the marvel of transistors! Printed circuit requires no wiring—just assemble with a few solder connections and enjoy excellent reception over the full AM broadcast band. No tubes to burn out—no crystal. Compact—fits in the palm of your hand—operates for months from a single penlight cell. Transistor provides plenty of power for strong headphone reception. Complete with all parts, transistor and penlight cell. Shpg. wt., 8 oz.

Model S-765. Transistor Radio Kit **\$4.35**
S-266. Accessory Kit. 4000-ohm headphones and all parts for outdoor antenna..... **\$3.15**

FAMOUS knight-kit LAB KITS

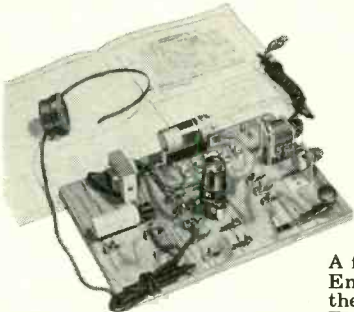

6-IN-1 RADIO LAB KIT

Model S-770 Build Any of 6 Electronic Projects
\$7.95

A fascinating and instructive kit. Enables you to build any one of the following projects: Standard Broadcast Receiver; Wireless "Home Broadcaster"; Code Practice Oscillator; Code Practice Broadcaster; Signal Tracer; Sine Wave Generator. Perfect for beginners. Once basic wiring is completed, circuits may be changed without soldering. Safe to build and operate; only tools needed are screwdriver, pliers and soldering iron. The ideal kit for students and beginners in electronics. Kit includes mounting board, tube, all parts and easy-to-follow instruction manual. Less headphone (also serves as mike). Shpg. wt., 6 lbs.

Model S-770. "6-in-1" Lab Kit. Net only..... **\$7.95**
J-112. Single 1000-ohm headphone for above..... **\$1.05**
C-100. Antenna kit for above..... **\$1.05**

10-IN-1 LAB KIT

Model S-265 Build Any of 10 Electronic Projects
\$12.65

A wonderfully instructive electronics kit. Ideal for experimenters, beginners—fun to build. Construct a sensitive Broadcast Receiver; Amplifier (for phono or mike); Wireless Phono Oscillator; Home "Broadcast Station"; Code Practice Oscillator; Capacity-Operated Relay, or any one of four other fascinating projects. Low voltages; safe to build and operate. Only tools needed are soldering iron, screwdriver and pliers. Perfect for self-instruction in circuit fundamentals, and packed with practical applications. Kit includes mounting board, tubes, all parts, hardware, microphone, and 12-page builders' manual. Shpg. wt., 10 lbs.

Model S-265. "10-in-1" Lab Kit. Net only..... **\$12.65**
J-112. Single 1000-ohm headphone for above..... **\$1.05**
C-100. Antenna Kit for above..... **\$1.05**

knight-kit WIRELESS BROADCASTER KIT



Model S-705 This fascinating unit makes it possible to "broadcast" with phonograph or microphone through any standard radio receiver up to 50 feet away—without any connection to the set. May be used with crystal or magnetic cartridge, or with microphone. Broadcasts a clear, full-toned signal. High-gain stage permits using magnetic cartridge without need for external preamp. Complete with all parts, tubes, wire and solder (less microphone). 4 1/2 x 5 x 6". Easy to assemble. Shpg. wt., 3 lbs.

Model S-705. Wireless Broadcaster Kit. Net only..... **\$9.50**
S-556. Microphone for above with 5-ft. cable..... **\$3.95**

knight-kit PHONO OSCILLATOR KIT



Model S-760 This low-cost phono oscillator may be used with any crystal phonograph for "broadcasting" recorded music through any standard radio receiver up to 50 feet away. Requires no direct connection to radio set. Operates on any frequency between 600 and 800 kc. Has controls for adjustment of modulation level and selection of clear frequency on radio receiver. Uses 50L6GT tube and 35Z5GT rectifier. Complete with all parts, tubes and instructions. 4 1/4 x 4 1/4 x 4 1/2". Shpg. wt., 1 lb.

Model S-760. Phono Oscillator Kit. Net only..... **\$5.85**

ALL PRICES NET F.O.B. CHICAGO



knight-kit CODE PRACTICE OSCILLATOR KIT

Model S-239 Transistor Circuit—Powered by Penlight Cell
\$3.95

An ideal code practice oscillator. Uses transistor circuit. Extremely low current consumption—powered by single penlight battery. Provides crisp, clear tone (400 to 600 cps). Has input jack for earphone; screw-type terminal strip for key. In compact bakelite case (2 3/8 x 3 3/4 x 1 1/2") with anodized aluminum panel. Complete with all parts, transistor, battery and easy-to-follow instructions. Shpg. wt., 1 lb.

Model S-239. Code Practice Kit.... **\$3.95**

See Next Page for Amateur Kits

order from **ALLIED RADIO** 100 N. WESTERN AVE., CHICAGO 80, ILL. →

ALLIED'S own knight-kits give you the most for your money

BUILD YOUR OWN QUALITY HI-FI AMPLIFIER!

knight-kit
BASIC 25-WATT
LINEAR-DELUXE
HI-FI AMPLIFIER KIT

Model S-755
\$44⁵⁰

Williamson-Type Circuit
 Printed Circuit Board
 Chrome-Plated Chassis



This super-quality hi-fi basic amplifier is designed to satisfy the most critical listener. Intended for use with tuners incorporating built-in preamp or with separate preamp. Incorporates latest Williamson-type circuit and has potted matched transformers. Delivers maximum output of 45 watts. Frequency response is: ± 0.5 db, 10 cps to 120 kc, measured at 20 watts. Harmonic distortion is only .15% right up to 30 watts. Intermodulation distortion is only .27% at 10 watts and only .4% at 20 watts, using 60 cps and 7 kc, 1:4 ratio. Hum level is -85 db below full rated output. Output impedance, 4, 8, 16 ohms. Input voltage for 25-watt output is 1.8 volts. Uses two 12AU7's, two 5881's, and a 5V4. Etched circuit is utilized in voltage amplifier and phase inverter stages to speed assembly. Has output tube balancing control, variable damping control, and on-off switch. Handsome chrome-plated chassis, 14 x 9 x 2". Overall height, 7". A deluxe true hi-fi amplifier equal in performance to amplifiers selling at over twice the price. Complete with all parts and tubes. Easy to assemble. Shpg. wt., 27 lbs.

Model S-755. Basic 25 Watt Hi-Fi Amplifier Kit. Net only **\$44.50**
 S-759. Metal enclosure for above; black finish. 3 lbs. Net. **\$4.25**

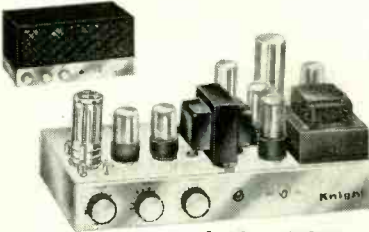

knight-kit
10-WATT HI-FI AMPLIFIER KIT

Model S-753
\$23⁵⁰

Chrome-Plated Chassis
 Famous for wide response and smooth reproduction at low cost. Only 0.5 volt drives amplifier to full output. Frequency response: ± 1 db, 30-20,000 cps at 10 watts. Harmonic distortion less than 0.5% at 10 watts. Intermod. distortion less than 1.5% at full output. Controls: on-off-volume, bass, treble. Input for crystal phono or tuner. Chromed chassis; punched to accommodate magnetic cartridge preamp. Matches 8 ohm speakers. Shpg. wt., 14 lbs.

Model S-753. Amplifier Kit. Net. **\$23.50**
 Model S-235. Preamp Kit for above **\$3.10**
 S-757. Metal Enclosure. 3 lbs. **\$3.95**

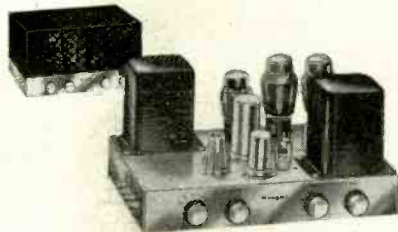

knight-kit
20-WATT HI-FI AMPLIFIER KIT

Model S-750
\$35⁷⁵

Chrome-Plated Chassis
 True hi-fi for less! Frequency response, ± 1 db, 20-20,000 cps at 20 watts. Distortion, 1% at 20 watts. Hum and noise level: tuner input, 90 db below 20 watts; phono 72 db below 20 watts. 4 inputs: magnetic phono, microphone, crystal phono or recorder, and tuner. Controls: Bass, Treble, Volume, Selector. With compensation positions for 78 and LP records. Built-in Preamp. Outputs: 4, 8, 16 and 500 ohms. 23 lbs.

Model S-750. 20-Watt Kit. Net. **\$35.75**
 S-758. Metal Enclosure. 3 lbs. **\$4.15**
 S-752. Chrome-plated escutcheon for cabinet installation of amplifier. Net. **\$1.40**

LOW-COST TOP QUALITY
KITS FOR THE HAM



knight-kit
Model S-255 50-WATT CW TRANSMITTER KIT
\$43⁷⁵

Built-in Pi-Type Antenna Coupler
 Check the features packed into this new transmitter kit and you'll see why it's one of the greatest Amateur values ever offered. Compact and versatile, it is the perfect low-power rig for the beginning Novice or seasoned veteran. Features: 50 watts input to 807 final; high-efficiency 6AG7 modified-Pierce oscillator takes crystal or VFO without circuit changes; bandswitching coverage of 80, 40, 20, 15, 11-10 meters; pi-section antenna output matches line impedances from 50 to 1200 ohms —permits use with any type of antenna; no separate antenna tuner required. Crisp, clean, cathode keying of oscillator and final. Power take-off plug supplies filament and B-plus voltages for other equipment. Copper-finished chassis and cabinet interior, filtering, shielding, bypassing, and coaxial SO-239 antenna connector provide excellent TVI suppression. Meter reads either plate or grid current of final. Jacks for VFO, crystal and key. Supplied with all parts and tubes. Less crystal and key. $8\frac{3}{4}$ x $11\frac{1}{4}$ x $8\frac{3}{4}$ ". Shpg. wt., 18 lbs.

Model S-255. 50-Watt Transmitter Kit. Net. **\$43.75**



knight-kit
SELF-POWERED
VFO KIT

Model S-725
\$28⁵⁰

Complete with built-in power supply! Careful design and voltage regulation assure high stability. Excellent oscillator keying characteristics for fast break-in without clicks or chirps. Full TVI suppression. Has plenty of bandspread: separate calibrated scales for 80, 40, 20, 15, 11 and 10 meters; vernier drive mechanism. 2-chassis construction keeps heat from frequency determining circuits. Output cable plugs into crystal socket of transmitter. Output on 80 and 40 meters. With Spot-Off-Transmit switch for "no swish" tuning. Extra switch contacts for operating relays and other equipment. With all parts and tubes. 8 lbs.

Model S-725. Self-Powered VFO Kit. Net. **\$28.50**



NEW knight-kit
AMATEUR RF
"Z" BRIDGE KIT

Model S-253
\$5⁸⁵

Measures standing wave ratio (SWR) and impedance of antenna systems; also for adjusting antenna networks for optimum results. Any VOM may be used for null indicator. High accuracy with 20,000 ohm/v VOM. Correction factor info supplied for other VOM's. With coax input and output connectors. Meters direct input and bridge voltage. Calibrated dial gives direct impedance reading; includes 1% precision resistor for precise calibration adjustment. With all parts and handy plasticized SWR chart. $1\frac{1}{2}$ lbs.

Model S-253. "Z" Bridge Kit. Net only **\$5.85**

ALLIED RADIO

100 N. WESTERN AVE., CHICAGO 80, ILL.

Our
 36th year

ALLIED RADIO CORP., Dept. O2-M-6, 100 N. Western Ave., Chicago 80, Ill.

Ship me the following KNIGHT-KITS:

Quantity	Description	Model No.	Price

\$ _____ enclosed. For parcel post include postage (express is shipped collect).

Name _____

Address _____

City _____ Zone _____ State _____

← **order Today**



TV Service
CLINIC
conducted by
JERRY KASS

LAST month's TV Clinic confined itself to a discussion of key dc test points as aids to rapid TV troubleshooting. Using an oscilloscope another dimension can be added to this type of quick testing. The scope displays the waveform of a signal and indicates its peak-to-peak value. This provides an interpretation impossible with the vtvm. Observations such as the relative amplitude of horizontal and vertical sync pulses and sweep waveshapes are possible.

Starting at the receiver input, the first—and probably most significant—check point in the set is at the video detector load resistor. By starting at the video detector no demodulator probe is necessary and the signal is strong enough to permit accurate peak-to-peak voltage measurements.

Generally, the strength of an incoming TV signal ahead of the video detector can be checked qualitatively by observing its relative strength as it passes from the tuner through the if amplifier. This method is good enough in checking for a weak or dead stage.

An expensive oscilloscope is not necessary for this type of checking on a black-and-white receiver. A narrow-band scope having a vertical amplifier with uniform response to 0.5 mc will do an excellent job of showing up the rectangular pulse and sawtooth sweep waveforms; the waveshape of the video content is unimportant here.

The signal developed at the video detector load or the grid of the first (and sometimes only) video amplifier stage may be as low as 2 volts peak to peak and as high as 8 volts or so. Observe the signal with the scope synced at half the horizontal and the vertical sweep frequencies. The vertical and horizontal pulse heights should be approximately equal (allowing for scope characteristics which can be checked on normally operating receivers). If there is a significant difference in amplitude, or both pulses are depressed, with possible sync instability and picture smear, check alignment of the tuner and if amplifier. Check carefully the setting of the video carrier on the slope of the if response curve.

The gain of a video amplifier stage is usually between 10 and 25. This can vary, depending upon the number of stages used and the desired signal voltage for driving the picture tube. In typical single-stage video amplifiers such as the Motorola chassis TS-537 about 3.3 volts appears at the video amplifier grid and 85 volts peak to peak at the plate. The G-E model 21T038 has a grid voltage of 8 and a plate voltage of 120. The peak-to-peak plate voltage is not always delivered to the driven element of the picture tube. There may be coupling losses due to contrast control settings or to coupling components. The Du Mont RA-356 and RA-357 has a grid voltage of 3.5 and a peak-to-peak plate voltage of 80.

In typical two-stage video amplifiers the RCA KCS83 chassis produces 2 volts at the grid of the first video amplifier and 41 volts peak to peak at the plate. Through coupling losses, about 15 volts peak to peak appear at the grid of the second video amplifier. This is increased to 120 volts at the plate. In the Du Mont RA-372 and RA-373 chassis (Fig. 1) the grid of the first video amplifier reads 3 volts peak to peak and the plate 50 volts. The grid of the second video amplifier receives a 30-volt peak-to-peak signal with 140 volts at the plate.

The above and following signals are based on receivers in a good signal area and adjusted for a normal picture.

The input to the sync amplifier-clipper circuit is usually taken from the plate circuit of the video amplifier and is generally about 30 volts peak to peak. This can range from as low as 10 to as high as 50 volts, depending upon circuitry. After the horizontal and vertical pulses have been stripped and amplified, the pulses in the plate circuit of the final sync amplifier-clipper, prior to integration and differentiation, are approximately 50 volts peak to peak. Again, this may vary from 30 to 70 volts or so.

In cases of sync instability check these stages for sync compression and for unequal amplitude of horizontal and vertical pulses. Be sure all video information has been removed.

Checking voltages and waveforms in the vertical and horizontal sweep sections is difficult unless the technician is familiar with the various types of oscillator and afc circuits used. However, important universal check points are at the grid and plate of the vertical and horizontal output stages.

The sweep voltage on the grid of the vertical output tube usually has a peak-to-peak value of about 60. Varying with circuitry, this could be as little as 35 volts or so and as high as 80, having the general waveshape as shown in Fig. 2-a. The average peak-to-peak value of the vertical sweep signal at the output tube plate is about 1,000 volts, rarely going much below 700 volts and sometimes going as high as 1,500. The general waveshape is shown in Fig. 2-b. Because of the high voltage in the plate circuit an appropriate capacitance type voltage-divider probe must be used.

In vertical distortion or loss of vertical sweep, the above observations quickly help isolate the trouble to the vertical oscillator, output stage or deflection-coil circuits.

The horizontal output stage provides a similar set of measurements. The waveform at the grid of the horizontal output is an extremely important indication of whether high voltage and raster trouble occur before or after this stage. The grid waveform has the general appearance of Fig. 3, having a peak-to-peak amplitude of approximately 100 volts. Due to drive control settings and circuitry this may vary from as low as 60 to as high as 170 volts (check the grid bias—it should read about one-fourth to one-third the peak-to-peak value).

The plate signal voltage is somewhat difficult to read, being about 5,000 with a variation of perhaps 1 kv. Most technicians prefer to check this test point by drawing an arc. A waveform can be obtained by connecting the scope to a gimmick loosely wrapped around the plate lead. However, the proper thing to do is to use a commercial 100-to-1 capacitance type voltage divider which can be adjusted for a given scope. This gives a safe and accurate voltage check and an indication of oscillation or ringing.

Other scope observations possible are the deflection-coil current waveforms by reading across a 10-ohm resistor placed in series with the coil, and power supply hum. In a conventional full-wave rectifier the 120-cycle component might read about 15 volts at the cathode or filament and 1 volt at the output of the filter.

Most important: know your scope and probe. And the best way to find out about them is to check waveforms on normally operating sets.

Narrow raster

I have a new Westinghouse chassis V-2340 on the bench with insufficient width. The usual checks and adjustments indicated no components at fault.

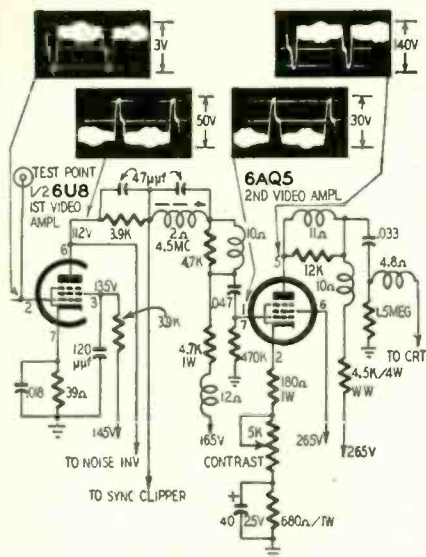

Fig. 1—The two-stage video amplifier in Du Mont RA-372 and RA-373 chassis.

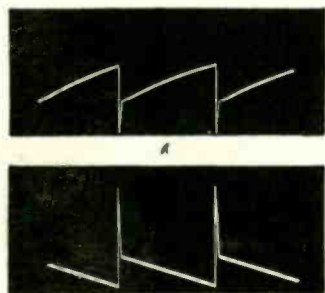

Fig. 2—Normal deflection waveforms at grid (a) and plate (b) of the vertical output tube.

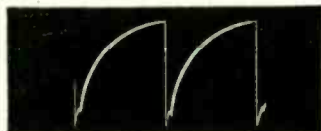

Fig. 3—The sweep waveforms at the grid of the horizontal output tube.

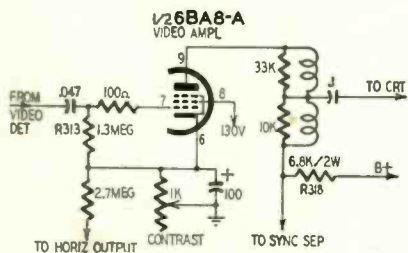

Fig. 4—Video amplifier in Admiral 14YP3B television chassis.

I hesitate to make any circuit modifications because the set was just recently purchased and the trouble is most likely some defective part. I tried placing a capacitor across sections of the flyback and this improved the width very slightly. I would appreciate some method of locating the cause of the reduced width. The picture is fine and the raster is bright and linear.—L. T., Buffalo, N. Y.

Several queries have come in on this symptom on the Westinghouse V-2340.

Thus, if you have made a thorough check of the horizontal output and the damper circuits, chances are that the trouble may be in the basic design of the chassis. This is most likely the trouble because later models of this set contain capacitors in the flyback circuit such as you attempted, in addition to reduced resistance values in the horizontal output screen circuit.

Connect a capacitor of about .001-.005 μ f across the age winding. This is terminals 3 and 4 on the flyback transformer. The capacitor should have a rating of approximately 1,500 volts. Also, lower the screen grid resistance, thus increasing the screen voltage. Replace the present 8,200-ohm 4-watt screen resistor with a 6,800-ohm unit or connect a 33,000-ohm 1/2-watt resistor in parallel with the present unit.

Silvery picture

An Admiral 14YP3B chassis has a negative or silvery picture on strong signals or with the contrast control turned up. I have aligned the set but this did not help. I am sure signal overload is the trouble because an attenuator pad in the antenna circuit clears up the defect. The contrast control has been replaced and all voltages checked to no avail. A careful check of the age circuit also indicates that everything is operating properly. I would like to know if there is anything I can do about this as I live in a strong signal area.—B. C., Chicago, Ill.

As a double check, see that the local-distant switch is in the local position. This shunts the antenna input with a 470-ohm resistor. Replace the 6BA8-A video amplifier (Fig. 4). The tube may be gassy. Check all components in the video amplifier stage, particularly grid resistor R313 and plate resistor R318. Replace any off value more than 10%.

Of course, it is always possible that the picture tube may be at fault, having low emission or being gassy. If convenient, make this check first.

Improving sound gain

In what is considered a fringe area, I am receiving fairly good programs on my Stromberg-Carlson 621CDM. The picture is fine but the sound is a little weak. I have tried orientation of the antenna and have carefully aligned the set. All tubes in the audio circuits have been checked and all voltages and components tested. I would like to know if Stromberg-Carlson has issued any circuit modifications for improving sound in this set.—J. M., Hancock, N.Y.

The model you have has a rather good sound section and I have not heard of any general complaint or circuit modification. If you have the manufacturer's service notes and are satisfied that the set has been completely aligned and checked, try the following: Turn to one of the weaker stations that you regularly watch and adjust the fine tuning for best picture. Then, without touching any other control, adjust the slug at the top of the

ratio-detector transformer for best sound. This will slightly improve overall sound gain.

Tube substitution

This is not the usual type question you receive, but for some time I have used the 6BA6 as a substitute for the 6AU6. It has worked very well but I am told that the set is harmed by doing this. Both tubes are pentodes and fairly similar. Furthermore, I have never heard of any complaint or callback involving this substitution. I would like your opinion on their interchangeability.—G. R., San Diego, Calif.

There are many cases where tubes having widely different characteristics may be substituted in a given circuit. In the substitution of the 6BA6 for the 6AU6 you have tubes whose major differences are in their cutoff characteristics. The 6AU6 is a sharp-cutoff pentode, the 6BA6 a remote-cutoff type. Other than this, in typical operation, their plate resistance, transconductance and plate current are reasonably close. This does not mean that substitution will necessarily work both ways. A remote-cutoff tube on occasion may give slightly inferior but acceptable performance in a circuit requiring a sharp-cutoff tube. However, a sharp-cutoff unit will not usually perform well in a circuit requiring a wide grid-control range.

Thus, for optimum performance, try always to use exact tube replacements. Don't make a general rule of a condition that works out satisfactorily in a given case. Your substitution will not harm a set current-wise.

Heater-line resistor

I have made three service calls on a Sylvania chassis 1-527. Each time the trouble was traced to a defective 6AK5. In two cases the tube heater was open but the other tubes were lit because the 6AK5 is shunted with a resistor. When I inserted a new tube, the heater voltage measured normal. The shunt resistor measured about 20 ohms, which is only slightly higher than the schematic calls for. I replaced it with a 2-watt unit but since then I have had another blown 6AK5. Perhaps I am overlooking something very simple and would appreciate your comments.—R. H., Akron, Ohio

In heater strings such as these, an open heater strings will often damage the shunt resistor. Thus, before replacing the defective tube, carefully check the shunt resistor. In your chassis the resistor is a 15-ohm 5-watt unit. Possibly some other technician had replaced the original resistor with the 2-watt.

Be sure you have the correct resistor—this one is mounted on the chassis near the tuner, not inside. The 6AK5 should not be left out of the chassis for any length of time because the shunt resistor is overloaded and will change value, causing poor receiver operation or possibly damaging the new 6AK5 when it is inserted. END

MF C	50+30 MF 150 WVDC	10+10 MF 300 WVDC	40/25 MF 250/25 WVDC	40+40 MF 150 WVDC	60/10 MF 350 WVDC
	SPRAGUE	SPRAGUE	SPRAGUE	SPRAGUE	SPRAGUE
	TWIST-LOK*LYTIC TVL-2510	TWIST-LOK*LYTIC TVL-2575	TWIST-LOK*LYTIC TVL-2515	TWIST-LOK*LYTIC TVL-2570	TWIST-LOK*LYTIC TVL-2570
	20+10 MF 150 WVDC	40+40 MF 300 WVDC	20+20 MF 250 WVDC	60+60 MF 300 WVDC	60+60 MF 300 WVDC
	SPRAGUE	SPRAGUE	SPRAGUE	SPRAGUE	SPRAGUE
	TWIST-LOK*LYTIC TVL-2438	TWIST-LOK*LYTIC TVL-2435	TWIST-LOK*LYTIC TVL-2435	TWIST-LOK*LYTIC TVL-2435	TWIST-LOK*LYTIC TVL-2435
	60+60 MF 150 WVDC	50+50 MF 150 WVDC	50+50 MF 150 WVDC	50+50 MF 150 WVDC	50+50 MF 150 WVDC
	SPRAGUE	SPRAGUE	SPRAGUE	SPRAGUE	SPRAGUE
	TWIST-LOK*LYTIC TVL-2430	TWIST-LOK*LYTIC TVL-2430	TWIST-LOK*LYTIC TVL-2430	TWIST-LOK*LYTIC TVL-2430	TWIST-LOK*LYTIC TVL-2430

for the **RIGHT**
'LYTIC replacement

...use an exact
SPRAGUE replacement



When you buy a Sprague Twist-Lok® electrolytic capacitor, you get the design preferred by the leading TV-Radio set makers, for Sprague makes far more twist-mount capacitors than any other source. Every Sprague TVL replacement electrolytic is made to original equipment specifications with the same know-how and production facilities that serve the discriminating set-makers. There is no guesswork in the design of Sprague Twist-Loks. Sprague has the original circuit requirements which must be designed for.

Every TVL for every voltage rating is made with the more expensive high-purity etched-foil anode construction using ultra-stable film formation techniques. Cathodes are etched to meet high ripple requirements. Sprague TVL's give maximum trouble-free service as well as long shelf life. They perform as well in auto sets in cold climates as they do in TV receivers in the sub-Tropics, and yet this premium quality costs you no more.

don't be vague...insist on

SPRAGUE®

world's largest capacitor manufacturer

SPRAGUE RESEARCH IS CONSTANTLY PRODUCING NEW AND BETTER CAPACITORS FOR YOU

Sprague Products Company • Distributors' Division of the Sprague Electric Company • North Adams, Massachusetts.

By
ROBERT G. MIDDLETON*

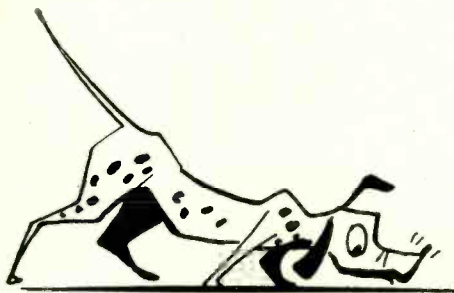

tracking
down
an
intermittent

INTERMITTENT dogs are among the worst; so much time must often be spent waiting for the intermittent to appear. A dog was brought in which had sync pulling, with the picture wavering horizontally in an intermittent manner. The wavering was not well defined and the pulling occurred randomly, sometimes almost to the extent of tearing; at other times with only slight momentary pulling. This uncertain horizontal sync was frequently accompanied by streaks of noise which flashed horizontally through the picture. It looked as though a high-voltage arc might be present except that the pulling and tearing were not always associated with the random noise streaks. Then, when the chassis was pulled from the cabinet, the intermittent suddenly stopped.

New tubes had been tried and most of the capacitors and resistors in the horizontal sync circuit had been replaced. According to the customer the trouble became progressively worse after the receiver was turned on for some time. For this reason, it appeared that there might be some type of thermal intermittent in the sync circuits. However, since the sync circuit had been practically rebuilt, with no change in the symptoms, there were few components which could be suspected. A heat lamp was not available so the technician started work by tapping resistors, capacitors and inductors at random. This approach led nowhere and it was clear that the intermittent was not mechanical.

Variable line voltage no help

In another attempt to make the intermittent start up, a variable line-voltage transformer was connected to the receiver and the voltage run from 90 to 130. The set operated like a normal receiver under the same circumstances. So it began to appear that the initial surmise of a thermal intermittent was correct and the technician sent out for a heat lamp. (There is no excuse for

* Chief field engineer, Simpson Electric Co.

any service shop not to have a heat lamp available!)

Intermittent starts again

Almost as soon as the heat lamp was applied a slight wavering and random pulling appeared in the picture. This condition rapidly became more severe and soon was the same as when the receiver had been operating for some time in the cabinet. However, since the rays from the heat lamp fell on a rather wide area, the next problem was to run down the faulty component.

Discussion arose as to whether the intermittent could really be in the sync circuit since it had been practically rebuilt. The high-voltage circuit was ruled out since the noise streaks occurred at random. However, it was suggested that picture pulling could arise from an intermittent in the agc circuit, causing transients in the video signal. The objection to this theory was that the picture didn't exhibit the usual effects of subnormal agc voltage. There might have been a little change in contrast with the picture pulling, but if so it would be classified as a possibly unrelated symptom.

At any rate, it would be easy to rule out the possibility of agc trouble.

Bias box stabilizes sync

A variable-bias box was obtained and the output applied between the agc bus and chassis ground. Immediately the picture pulling was under control. When the bias was set at -1.5 volts a normal contrast picture was obtained, with little or no pulling. As soon as the bias box was disconnected the random pulling started again.

Since it was now established that the trouble was in the agc system, a vtvm was connected to the agc bus. The pointer moved to some extent when the more severe picture pulling occurred. It seemed likely that the intermittent was very rapid, so that change in picture contrast was hardly noticeable for the duration of the intermittent. However, the intermittent did insert

noise pulses in the video signal of sufficient intensity to upset the horizontal phase discriminator.

It remained now only to run down the intermittent component in the agc system. Someone suggested at this point that we could mount the bias box in the receiver and leave it connected since there is only one TV station in this section of the country. This cure was not seriously considered although it brought back a recollection of the time that a radio receiver had been brought in for repair.

A nonstandard repair, that one

To digress from the main issue for a moment, this radio was brought in for replacement of filter capacitors. However, a large black box wrapped in friction tape was mounted below the chassis, with two leads coming out. One lead was attached to the plate of a tube, the other returned to some other circuit point. At first we replaced the filter capacitors and turned the set on. It played satisfactorily, and usually we would have let it go at that.

But the black box was a little too much for human curiosity, so we unwrapped it. Great jumping jupiter! It was a volt-ohmmeter wrapped up in the tape. When the volt-ohmmeter lead was disconnected from the circuit, the radio stopped playing. It turned out that there was a nearly open resistor in the circuit, which was "repaired" by applying the input resistance of the meter.

How about that?

Finding the intermittent

To get back to the TV receiver, the intermittent component was next sought by holding the tip of a soldering gun near one component after another in the agc system. When a resistor in the agc keying tube was heated in this manner, the sync started to go crazy and we knew we had at least localized the main trouble. Fig. 1 shows the location of this resistor. The triode agc keyer tube in this circuit is uncommon but troubles caused by high-amplitude pulses across

resistors are, unfortunately, not rare.

When the resistor was replaced, the horizontal sync instability was cleared

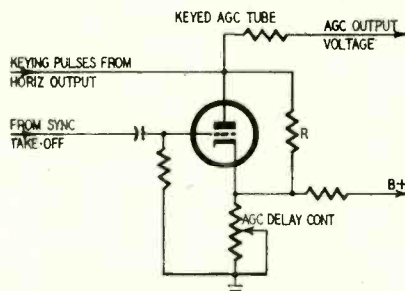

Fig. 1—Bad resistor R between plate and cathode affects sync stability.

up completely. The picture could not be made to pull by further application of the heat lamp. However, another symptom now appeared.

Capacitor is a battery

The picture began to compress vertically with application of the heat lamp, until it looked like the raster was made of rubber. This was obviously vertical trouble which we had overlooked before because of the prominent nature of the horizontal trouble.

Double trouble! Well, it could be localized by the same means as before. The tip of the soldering gun was next held near various of the vertical-sweep components in turn. When it was held near peaking capacitor C (Fig. 2), the

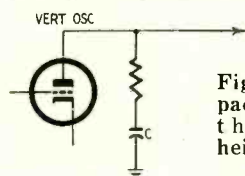

Fig. 2—Peaking capacitor, among other things, affects height of raster.

picture responded enthusiastically, becoming about 4 inches high. This was a .002- μ f capacitor which when replaced took care of most of the vertical stretch.

But this capacitor was a puzzler. When placed across the dc voltage terminals of a vtvm, it deflected the pointer $\frac{1}{2}$ volt. If the terminals of the capacitor were reversed, it deflected

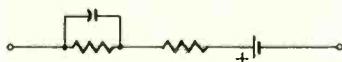

Fig. 3—Equivalent circuit of defective capacitor acting as a weak battery.

the pointer $\frac{1}{2}$ volt in the other direction. The deflection gradually dropped off. But upon giving the capacitor a short rest, it would again generate a voltage and deflect the pointer. It was one of those infrequent cases where electrolysis takes place in a faulty capacitor and causes it to act as a weak battery. (See Fig. 3.)

However, it was not the small voltage generated by the capacitor which was causing the vertical trouble. The capacitor was leaky as well and its leakage resistance was thermally responsive. The battery action of the capacitor was merely a side issue—one of the TV servicing sideshows which makes life more interesting in the back shop. END



By ROBERT B. COOPER

THE Perseids meteorite shower occurring during the second week of August provided many dxers with an excellent chance to look into this business of meteor-scatter dxing. Not a few found the results fascinating, while many of the old hands added numbers of stations to their dx totals. Although meteor-scatter dxing (termed MS by those in the know) is supposed to provide bursts only within single-hop sporadic-E range (500–1,500 miles), several alert observers are logging much longer distances. Collin of Buffalo, N. Y., notes verified reception from Billings, Mont., and Salt Lake City, Utah. Lupton of Shelbyville, Ill., notes Las Vegas, Nev., during August. Observer Burch of Hot Springs, Ark., reports that stations were identified via MS on all but two days between July 25 and August 24. Total station identifications were 68. Although the meteorites entering our E-layer are capable of bringing MS reception of some form on any day of the year, definite peaks do occur when meteorite showers really push the burst count up. Such a peak will occur during the period of December 11–14, as an annual shower appears. All dxers should also be alert for high-band (channels 7–13) bursts during this period.

Dxer Rauch, residing in Peoria, Ill., reports two loggings that will undoubtedly bring up an old controversy again. In the past few years, several high-band loggings of rather phenomenal distances have been reported to this editor. In the first few instances, we merely assumed them to be a case of mistaken identity. But as more of these loggings turned up, the facts were hard to ignore. As the following information will probably show, we are apparently experiencing an entirely new form of wave propagation that requires a lot of investigation.

In the early morning hours of August 31, Rauch was able to log five minutes of reception from channel 11, KTTV, Los Angeles, Calif. This distance is just over 1,700 miles. As if once wasn't enough, Rauch notes that a repeat performance occurred on the morning of September 19, between 0110 and 0200 CDT. Complete program information was copied, which checks very nicely with the station programming. Rauch also notes that the antenna heading was extremely critical, and that reception did not fade in and out, but rather, "popped" in and out as if someone turned the transmitter on and off. The signal strength was weak, but readable.

Several other loggings in the past few years might be worth some mention at this time. Brown of Barstow, Calif., caught KWWL-7, Waterloo, Iowa, in the same manner in July, 1955. Burch of Hot Springs, Ark., notes KZTV-8, Reno, Nev., in June, 1955, while Seybold of Dunkirk, N. Y., saw not one, but several stations by the same type of propagation on July 26, 1955. Included were WFAA-8, Fort Worth, and KGUL-11, Galveston, Tex., KWTW-9, Oklahoma City, Okla.; KOLN-10, Lincoln, Neb., and KTVH-12, Hutchinson, Kan. In the past years, this column has reported similar reception of KTTV, Los Angeles, Calif., in several spots in Indiana and Wisconsin. And not to be forgotten are the loggings of Rugel, Independence, Kan., who saw WTOP-9, Washington, D.C., and Startzman, Bennington, Kan., who noted WICU-12, Erie, Pa., on the same day that Seybold noted the various Midwest stations.

The interesting part about these loggings is that no other stations than those normally seen were logged when this dx was noted. Ground wave was not noted to be better than average in any of the instances. The periods of reception vary from early morning to late evening, with only one logging noted between 0900 local time and 2000 local time. Reception was never too strong, but always steady. In each case, reception was from June 15–Sept. 30.

As these reception reports seem to involve a new form of wave propagation, not yet known to propagation enthusiasts, RADIO-ELECTRONICS is endeavoring to collect as many similar reports as possible. If you can add to our growing file of reports, please do so.

Special Reports

A special MS report on hand from observer Bedford Brown, Hot Springs, Ark., is of definite interest. During a special early morning dx test put on by station WITN-7, Washington, N. C., for the dxers in the American Ionospheric Propagation Association (AIPA), Bedford noted 13 identifiable bursts in a period of one hour. This is a distance of 905 miles, and at a frequency of 175 megacycles. Bedford was able to draw correctly a test pattern and call slide.

The periods adjacent to July 7 and August 5 produced excellent ground wave (tropo) conditions from the mid-Gulf states to the area along the Great Lakes. Observers on both ends of the circuit report high-band loggings in excess of 700 miles, while the low-band

\$100,000

Hi-Lo is covered by a \$100,000.00 insurance policy issued by one of the largest insurance companies.*

GUARANTEED PERFORMANCE

Each and every Hi-Lo is backed by a money back guarantee. For the best reception, unsurpassed clear pictures, specify Hi-Lo, with the exclusive highest gain, spiral designs which are covered by the following U.S. patent numbers: 2,495,579; 2,583,745; 2,724,773; 2,748,387; 2,755,466; and Canadian Patents 1951 and 1956; other patents pending.

**New...
Just what
you asked
for!**

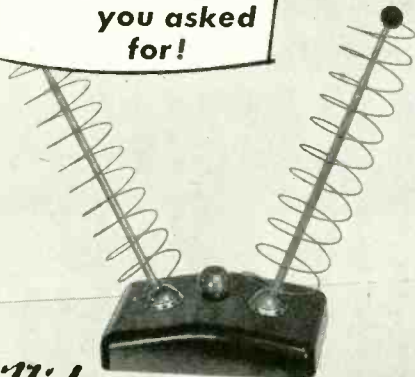

Hi-Lo Model 505 — Channels 2-83
The spiral antenna that is designed for maximum performance featuring the NEW TELESCOPING DIPOLES. This versatile antenna swivels on ball and socket in any direction. Gold spirals, plastic base blend with any room. LIST... \$14.95

**New...
For every
TV
owner**

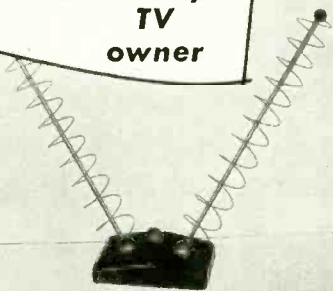

Hi-Lo Model 404 Channels — 2-83.
NEW INDOOR ANTENNA that swivels with a gentle touch of your little finger. Dipoles swivel on ball and socket in every direction. Golden spirals and decorative plastic base blend with all furniture. RECEPTION IS GUARANTEED. LIST... \$12.95

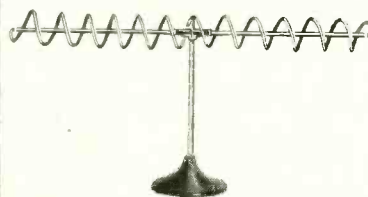

Hi-Lo Model 101 — Channels 2-13.
The original and world famous antenna that is wanted, demanded and used for GUARANTEED FINEST RECEPTION. No rods to adjust. Provides clearest pictures faster. LIST... \$9.95

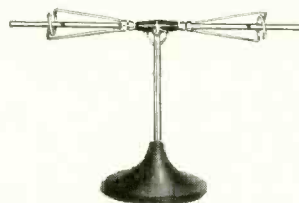

Hi-Lo Model 303 — Channels 14-83.
The UHF ANTENNA with the highest signal gain that is specially designed for ALL UHF areas. Luxurious gold upright and crossbar. LIST... \$5.95

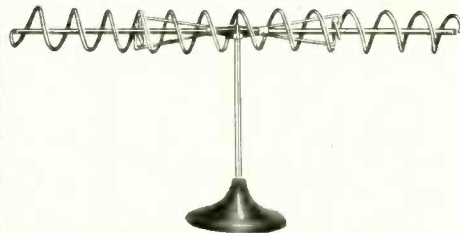

Hi-Lo Model 202 — Channels 2-83
PEAK PERFORMANCE which is unsurpassed is guaranteed with this antenna... for ANY and EVERY area. The gleaming gold upright, shiny spirals, bakelite base, aluminum bars, modern design

... all make this YOUR BEST ANTENNA BUY.

LIST... \$9.95

INSIST ON THE GENUINE Hi-Lo Spiral Antennas!
Known and accepted everywhere, Hi-Lo is manufactured and GUARANTEED by the best antenna manufacturer in the world. Hi-Lo is consumer accepted and approved.

Hi-Lo TV ANTENNA CORP.
3540 North Ravenswood Avenue
Chicago 13, Illinois

TELEVISION

tropos were good for 550-mile loggings. Observer Lupton of Shelbyville, Ill., notes uhf reception to 300 miles during the same period.

Rauch of Peoria, Ill., also notes reception from WOR, WABC and WRCA from New York, N. Y., via tropos on the AM on the 30th of August. This is a distance of 805 miles, and is the farthest west penetration of high-band signals from the Atlantic coast line that we know of.

Forecast for midwinter

For meteor-scatter dxing, the period of December 10-15 promises to be extra interesting. This is the period of an annual meteorite shower which has, in past years, been very productive. The evenings of December 12 and 13 usually produce the best dxing sessions, and observers interested in MS should not overlook the periods from 1100-1400 LST in the first two weeks of January.

F2 skip should have made its appearance, and long since receded for awhile, as you read this. Checking with the records of the past years of high F2 activity, we find that a dip should occur around December 1 and last until March 1, 1957. For all practical purposes, then F2 will be nonexistent for the next four months, at least here in the states. Observers in South America and the Pacific should continue to enjoy reception from 2,200 miles over.

Sporadic-E skip will begin to find its own about the time you read this. The annual upswing in E-sporadic occurrence usually peaks in mid-January, although some openings are expected throughout December. Almost all E's occurring during the next two months will take place between 1600 and 2000 LST (4 pm to 8 pm local standard time). The first openings will be noted in the more southern areas of the country, gradually spreading northward as January appears.

Tropospheric dx is expected to be poor over the whole country during the next three months. Occasional early morning and late evening openings are expected near large bodies of water, as storm fronts approach the receiving location.

Get your forms!

RADIO-ELECTRONICS provides TV dx forms for dxers reporting to this column. These are available free of charge by merely dropping a card with your name and address to TV DX Column, RADIO-ELECTRONICS, 154 West 14th Street, New York 11, N. Y.

The January issue of RADIO-ELECTRONICS is traditionally the Annual TV Issue. In accordance with this, we plan a review of the TV dx highlights of the year, notes on unusual loggings, and a listing of the members of the "Over 50 TV Dx Club."

With our column appearing in the January issue, as well as December, the next regular TV dx report and forecast will appear in March, 1957. END

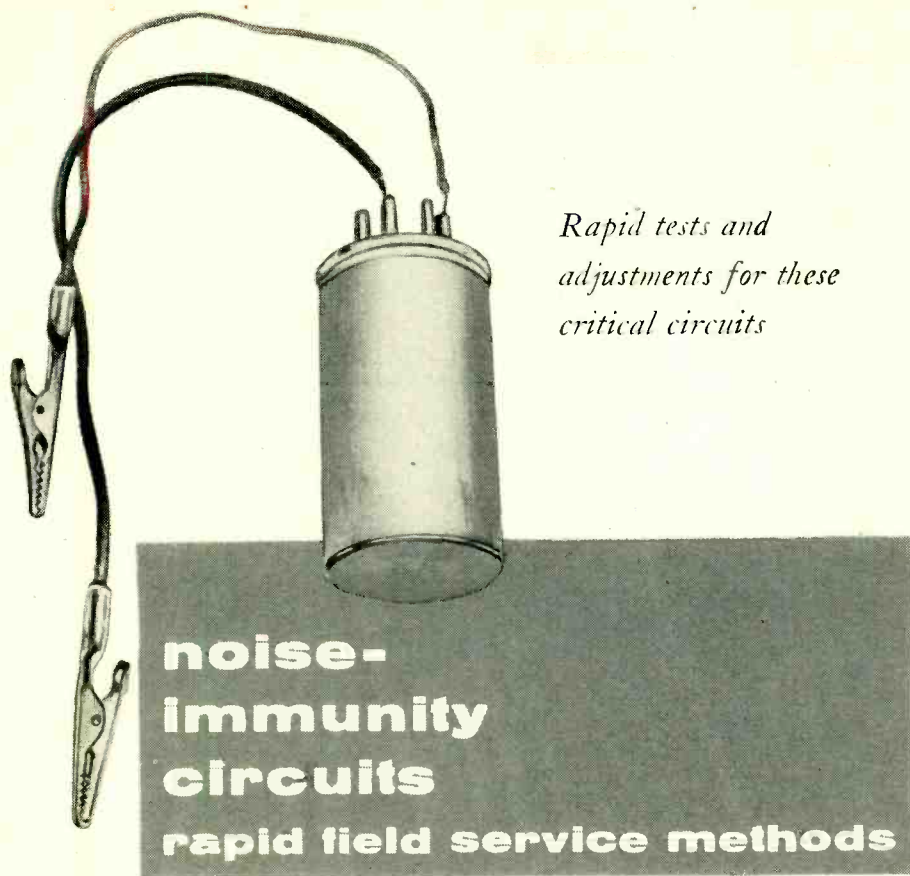

Fig. 1—A handy source of noise.

By JAMES A. McROBERTS

NOISE-IMMUNITY circuits are designed to prevent random noise pulses from affecting the sync circuits. Strong noise bursts cause the picture to roll vertically or tear horizontally in the absence of noise-immunity circuitry. These circuits often need minor adjustments and servicing in the field.

Fig. 1 shows a very handy noise source, an old vibrator that still vibrates but is so worn and noisy as to be unsuitable for auto radio use. Two leads are soldered to the base pins, making it a simple buzzer. Or, an ordinary doorbell buzzer may be used. The wire leads terminate in clips that are attached to the hot heater supply and to chassis ground, respectively. In series-string sets use a filament transformer or battery as a voltage source. A tube may be lifted partially from its socket for above-chassis ac-

cess. I usually pull the picture-tube socket back a trifle to expose the heater base prongs. Or employ any 6-volt noise source on hand.

Fig. 2 is the schematic of the noise source, a simple buzzer. A lead may be hooked to the hot filament lead and brought near the antenna lead to give greater noise injection if it is necessary.

Adjustment

For adjustments, simply clip the leads to the hot heater and chassis ground. Turn the noise control—whatever it may be called in that set—until the picture does not tear on a reasonably weak but usable signal. Do

not use too weak a station signal or there may be poor sync action even in the absence of noise. Too strong a signal produces poor operation on the weaker channels. In some types of sets the noise (from the buzzer or vibrator) will have to be turned on and off while making the adjustments. This simulates random noise bursts. A small variation of the control each time the vibrator is off will soon produce a stable picture when it is running.

Fixed type of control

Noise-immunity circuits fall into two categories:

1. *The cancellation type.* The noise signal is clipped (Fig. 3) from the sync (often the video) signal, inverted and fed back into the system 180° out of phase to cancel the noise, without adversely affecting the sync. The constants of the clipper are rather critical and adjusted at the factory by a cut-and-try procedure if an external control is not provided. This arrangement is used in the Magnavox series 160 and 107 and in other makes and models.

2. *The conduction type.* The path of the sync pulses is cut off (Fig. 4) as by a switch in the presence of noise. The switch is open when noise appears. This circuit, used several years ago by Philco, depends on a very critical state of near cutoff during normal sync. The inertia or flywheel action of the local oscillators (vertical and horizontal) are relied upon to keep the picture in sync when the switch or gate tube is nonconducting, i.e., when the switch of Fig. 4 is open.

3. *Shunt type.* Fig. 5 shows a shunt type noise canceller acting as a shunt switch. The switch conducts in the presence of noise above a level set by voltage divider R1, R2. The entire signal is removed when noise arrives at canceller.

These circuits may depend on rather critical adjustment of the bias or voltage determining the clipping action. Usually this takes the form of a voltage divider (R1, R2) from a B-plus supply bus, as in Fig. 4. Here any slight change of resistance values in the chain of resistors makes the circuit ineffective—it will either remain cut off all the time or not be driven to cutoff by noise. If a voltmeter is connected from the chassis to plate (Figs. 4, 5), or chassis

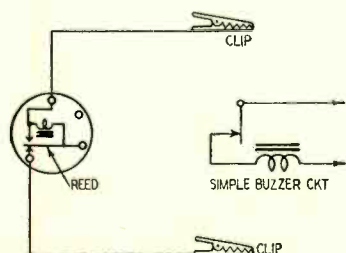

Fig. 2—Diagram of simple buzzer.

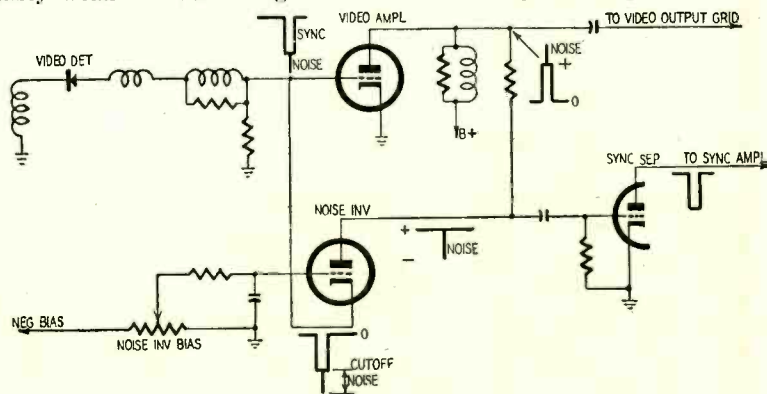

Fig. 3—A cancellation type circuit.

THIS professional TRAINING IS THE KIND THAT Really Pays Off!

... and it costs only a fraction of what you might expect to pay!

FIX ANY RADIO OR TV SET EVER MADE...easier...better...faster

Backed by the how-to-do-it methods so clearly explained in this one big 822-page book, you'll be prepared for fast, accurate service on any radio or television receiver ever made.

Radio & Television TROUBLESHOOTING AND REPAIR by Ghirardi & Johnson is far and away the world's most modern, easily understood guide. Step by step, it takes you through each service procedure... from locating troubles with less testing to repairing them promptly by fully-approved professional methods... the kind that enable you to handle tough jobs as slick as you now do the easy ones.

COMPLETE SERVICE TRAINING

For beginners, this giant book is a complete service training course. For experienced servicemen, it is a quick, easy way to "brush up" on specific jobs; to

develop better methods and shortcuts and to find fast answers to tough jobs.

Here are just a few of the subjects covered: Components and Their Troubles; Basic Troubleshooting Methods; "Static" and "Dynamic" Testing; Practical Troubleshooting Tips and Ideas; AC/DC, 3-way Portable and Battery Set Troubleshooting Problems; Servicing Communications Receivers; a Complete Guide to Television Service; AM, FM, and TV Realignment Made Easy; Resistor, Capacitor, Inductor and Transformer Problems; Servicing Tuning, Selector and Switching Mechanisms; Loudspeakers, Servicing Recorders and Record-playing Equipment... and dozens more. 417 illustrations. Read TROUBLESHOOTING AND REPAIR for 10 days AT OUR RISK!

Price only \$6.75 (or see money-saving combination offer.)

LEARN BASIC CIRCUITS FULLY...and watch service "headaches" disappear

It's amazing how much easier and faster you can repair radios, television sets and even industrial electronic equipment when you know all about circuits and what makes each one "tick."

You locate troubles in a jiffy because you know what to look for and where. You make repairs lots faster, better and more profitably!

Actually, there are only a comparatively few BASIC circuits in modern equipment. Radio & Television RECEIVER CIRCUITRY AND OPERATION by Ghirardi and Johnson gives you a complete understanding of these as well as their variations. It teaches you to recognize them... to understand their peculiarities and likely "troubleshooting" spots... and shows how to eliminate useless testing and guesswork in making repairs.

LEARN MORE—EARN MORE!

Throughout, this 669-page book with its 417 clear illustrations gives you the kind of above-average professional training that fits you for the better, big pay jobs in either servicing or general electronics. Covers all circuits in modern TV and radio receivers, amplifiers, phono-pickups, record players, etc. Price only \$6.50... or see money-saving offer in coupon. Examine it 10 days at our risk!

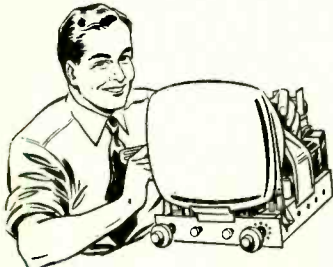

THESE FAMOUS BOOKS REALLY SHOW YOU HOW!

More radio-TV technicians have trained from Ghirardi books than any others of their kind! Almost 1300 pages and over 800 pictures and diagrams in these two new books explain things so clearly it's next to impossible for you to go wrong. Each book is strictly up-to-the-minute... NOT a re-hash of old, out-moded material.

FREE EXAMINATION...easy terms!

Dept. RE-126, RINEHART & CO., INC.
232 Madison Ave., New York 16, N. Y.
SEND books indicated for FREE EXAMINATION. In 10 days, I will either remit price indicated plus postage or return books postpaid and owe you nothing.
 Radio & TV TROUBLESHOOTING AND REPAIR (Price \$6.75) Radio & TV CIRCUITRY AND OPERATION (Price \$6.50)
 COMBINATION OFFER... Both books only \$12.00. (Price separately \$13.25... you save \$1.25) (Combination offer is payable at rate of \$3 [plus postage] after 10 days if you decide to keep books, and \$3 a month thereafter until \$12 has been paid.)

Name.....
Address.....

City, Zone, State.....
OUTSIDE U.S.A. ... \$7.25 for TROUBLESHOOTING & REPAIR; \$7.00 for CIRCUITRY & OPERATION; \$13.00 for both books; Cash with order, but money refunded if you return books in 10 days.

to cathode in some instances, the voltage change will indicate cutoff. That is, when there is no change the tube is in cutoff.

Potentiometers can be put in place of either R1 or R2 and varied until the tube remains cut off (for the nonconduction type) or until the noise clipping (in the cancellation type) just holds the picture stable. The pot is connected as a rheostat and adjusted for a stable picture in the presence of noise. Then the resistance of the potentiometer (rheostat) is measured and a fixed resistor inserted. A potentiometer may be left in the circuit if de-

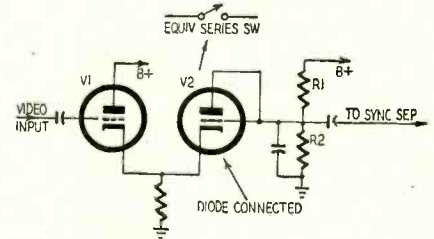

Fig. 4—A conduction type of circuit.

sired, for control. The same is true of the cancellation circuits.

Picture stability is the clue to correct adjustment. In cancellation circuits the noise inverter must invert an approximately equal amount of noise signal to function properly. There is some tolerance; the inverter will operate properly if the clipped inverted signal is about 75-80% of the noise pulse. Therefore cancellation is effective even if not perfect.

A pair of headphones (high-impedance) may be used with a series capacitor to listen to sync pulses in the non-conduction type of circuit. Listen to the sync pulses without the noise source (buzzer, vibrator), then turning on the noise should remove the sync pulses in the headset.

Similarly, an ac voltmeter with a series capacitor to block out the dc may be used. The voltmeter will indicate the sync pulses but is not an accurate indication since the meter is calibrated for rms ac in the common types. However, it will indicate cutoff. It will indicate (for the cancellation type) additional noise voltage (take a reading with source on and then off) and the inverted voltage. Although the readings may be only relative, that is all that is required. END

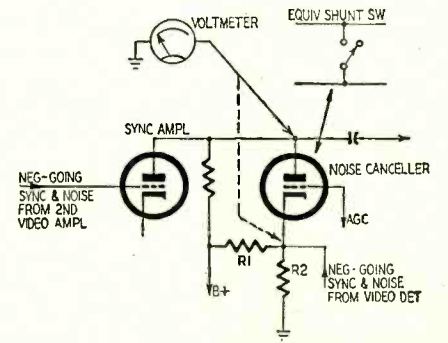

Fig. 5—A shunt type noise canceller.

ABBREVIATIONS and Symbols

By CHARLES S. KIMBALL
(Continued from November, page 81.)

D

- D—
- Electrostatic flux density.
- Density.
- Diameter.
- Layer of the ionosphere 50 to 100 kilometers above the earth.
- The prefix deci.
- Delayed avc.
- Decibel.
- Detector balance bias (radar).
- Decibel, 1-mw reference.
- Direct coupled (amplifier).
- Direct current.
- Direct current restorer.
- Double cotton covered (wire).
- Double Cotton Enamel (wire).
- Duplex dropout (telephony).
- 1/10 of any given unit.
- Deflection.
- 10 times any given unit.
- Greek letter symbol for:
 - 3-phase circuit arrangement in which the circuit configuration is shaped like the Greek letter.
 - Increment or decrement (capital or lower-case letter).
 - An impedance-matching arrangement (Delta match) for feeding a center-fed resonant antenna with a balanced transmission line of lower impedance.
 - Determinant (Capital).
 - Permittivity (Capital).
 - Density.
 - Angles.
 - Demodulator.
 - Detector.
 - Distant early warning (radar network)
 - Direction finder (or finding).
 - Dielectric.
 - Discharge.
 - Discriminator.
 - Distance measuring equipment.
 - Double pole double throw (switch or relay).
 - Double pole single throw (switch or relay).
 - Double silk covered (wire).
 - Distance (radio reception).
 - Dynamic.

DEMOD

DET

DEW

df

DIELECT

DISCH

DISCRIM

DME

dpdt

dpst

dsc

dx

DYN

E

- In radar, an indicator that presents target range and elevation data.
- Layer of the ionosphere 100 to 175 kilometers above the earth.
- In waveguide propagation, waves whose magnetic vector (H vector) is always perpendicular to the direction of propagation. Also known as TM waves.
- Voltage.
- Emitter (of transistor).
- Enamel covered (wire).
- Electric counter measures (radar).
- Electron-coupled oscillator.
- Extremely high frequency (band).
- Electric.
- Electrode.
- Electromotive force.
- Enamelled (wire).
- Equivalent noise sideband input.
- Expanded position indicator (radar).
- Electronic position indicator.
- Greek letter symbol for:
 - Dielectric constant.
 - Permittivity.
 - 2.71828 (base of natural logs).
 - Events per unit time.
 - Equivalent.
 - Erase head.
 - Effective radiated power.
 - Electrostatic shield.
- Greek letter symbol for:
 - Intrinsic impedance.
 - Efficiency.
 - Surface charge density.
 - Hysteresis.
 - Coordinates.
 - Electron-volt.
 - Early warning (radar).
 - Electronic warfare.
 - External or extension.
 - In vacuum-tube terminology:
 - Average or quiescent plate voltage.
 - Plate supply voltage.
 - Quiescent (no signal) plate voltage.
 - Maximum plate voltage.
 - Average or quiescent grid voltage.

E, e

ec

ECM

eco

ehf

ELEC

ELECT

emf

ENAM

enst

EPI

Epsilon (ε)

eput

EQUIV

ERASE HD

ERP

e/s

Eta (H, η)

ev

EW

EXT

E_b

E_{bb}

E_{bo}

E_{bm}

E_c



**Leave a trail
of happy customers...
replace with Sonotone Cartridges!**

Every time you replace with a Sonotone 1P (single-needle) or 2T (turn-over) you're sure of another highly satisfied customer. Both Sonotone Ceramic Cartridges give sparkling, long-lasting and trouble-free performance—almost always *better than original equipment*.

And every time you replace with a Sonotone, *you're better off, too*. Both models mount the same easy way—take care of over 90% of your quality replacement calls! With only 2 models to work with, you can do the *same job the same way*, time after time, easier and faster.

New standard of the phono industry

In more than half the quality phonographs made today by leading manufacturers, you'll find one of these Sonotone cartridges. All the more reason why *you* should standardize on Sonotone.

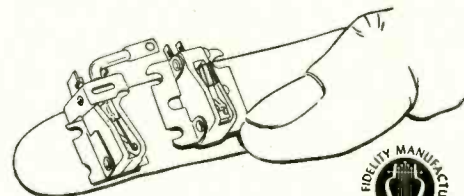

Electronic Applications Division

SONOTONE CORPORATION

ELMSFORD, N. Y.

IN CANADA, CONTACT ATLAS RADIO CORPORATION, LTD., 50 WINGOLD AVE., TORONTO



Easy Does it WITH Winegard

Most Winegard antennas are so easy to install that you can put them up in minutes. Without a helper, too! All of which means more time for you to put in on skilled service instead of on rooftops.

Only Winegard makes a complete, factory-assembled antenna installation. You get the whole package—nothing else to buy! Not a kit, but a completely assembled unit that opens easily as an umbrella. No loose parts. Nothing to put together. Nothing to attach. Fold it open—nail it up. (Special screw-type nails included!) Clip lead-in to terminals... and you're done!

There's a Winegard model for every area and every customer.

Nationally advertised in SATURDAY EVENING POST and other leading magazines.

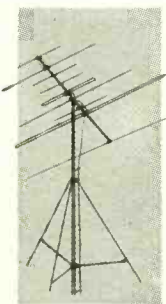

"Minute-Mount" Model

for fringe areas. A high-gain antenna with patented "Electro Lens" focusing and 10' aluminum fold-out tower. Factory-assembled and ready for installation. Complete, including lead-in, insulators, lightning arrester, ground wire and ground rod — \$44.95 retail.



See your Jobber, or write:

Winegard Co.

3000 Scotten Blvd., Burlington, Iowa

*Pat. No. 2700105

ABBREVIATIONS

(Continued)

- E_{cc} —Grid bias supply voltage.
- E_{cm} —Maximum grid voltage.
- E_g —Rms value of varying component of grid voltage.
- E_{g-I_p} —E_{g-I_p} curve: Graph of relation between grid voltage and plate current for specific type of vacuum tube.
- E_{gm} —Maximum value of varying component of grid voltage.
- E_p —RMS value of varying component of plate voltage.
- E_{pg} —Plate voltage in respect to grid.
- E_{pm} —Maximum value of varying component of plate voltage.
- E_{sg} —Screen grid voltage.
- e_b —Instantaneous value of varying component of grid voltage.
- e_c —Instantaneous value of total grid voltage.
- e_g —Instantaneous value of varying component of grid voltage.
- e_p —Instantaneous value of varying component of plate voltage.
- In color television:
 - E_b —Normal full blue signal.
 - E_b - E_y —The signal resulting from subtracting E_y from E_b.
 - E_r —Normal full red signal.
 - E_r - E_y —The signal resulting from subtracting E_y from E_r.
- F—
 - F —Farad (f in combination).
 - Magnetomotive force.
 - Luminous flux.
 - In mathematics, a function.
 - In radar, type of indicator that presents target azimuth error and elevation error.
 - In rf transmitter emissions, frequency or phase modulation.
 - U. S. Navy prefix for shipborne fire-control radar: FC, FD, FH, etc. Later changed to Mark III, Mark IV, Mark VIII, etc.
- F₁ —Layer of ionosphere 175 to 250 kilometers above surface of earth.
- F₂ —Layer of ionosphere 250 to 400 kilometers above surface of earth.
- f —Frequency.
- f₀ —Resonant frequency.
- FBRL —Final Bomb Release Line.
- FDM —Frequency Division Multiplex. (Carrier-Frequency Telephone.)
- FIL —Filament.
- FM —Frequency modulation.
- FOLL —Follower (ing).
- FPS —Feet per second.
- FTC —Foot-pound-second system of units.
- FREQ (f) —Fast Time Control (radar).
- frmv —Frequency.
- G—
 - G —Control grid of vacuum tube.
 - Electrostatic stress.
 - In physics, gravity.
 - In radar, type of indicator that presents (single signal only) target azimuth error and elevation error data.
- Gamma (γ) —Greek letter symbol for:
 - Complex propagation constant (cap.).
 - Specific gravity.
 - Electrical conductivity.
 - Propagation constant.
- GCA —Ground-Controlled Approach (radar).
- GCI —Ground-Controlled Interception (radar).
- GCL —Ground-Controlled Landing (radar).
- GCR —Ground-Controlled Radar.
- GCT —Greenwich Civil Time (navigation).
- GDM —Grid dip meter.
- GDO —Grid dip oscillator.
- GEN —Generator.
- GEOREF —World Geographic Reference System (navigation).
- GHA —Greenwich Hour Angle (navigation).
- GL —Gun Laying (radar).
- GM —Guided Missile.
- GND —Geometric mean.
- GPI —Ground.
- GT —Ground Point of Interception (radar navigation).
- GTC —Glass Type—in vacuum tube number designations: as 6SJ7GT.
- Gyro. —Gain Time Control (radar).
- Gyroscope.
- In vacuum-tube terminology:
 - g_c —Conversion conductance.
 - g_d —Dynamic conductance.
 - g_g —Grid conductance.
 - g_m —Mutual conductance or slope.
 - g_n —Plate-to-grid transconductance.
 - g_p —Plate conductance.
 - g_l —Grid No. 1; similarly, g₂, g₃, etc.
- H —
 - Magnetizing force.
 - Horizontal component of terrestrial magnetism.
 - Type of attenuator network having shape of letter H.
 - In waveguide propagation, waves whose electric vector (E vector) is always perpendicular to direction of propagation. Also called TE waves.

Shortcuts For SERVICE... PROFIT From R-Columbia

New FONO MAGIC

A compound of special rubber and carbide... eliminates turntable slipping-dragging. Makes automatic changers cycle properly.

ONLY
\$1.95
DEALER
NET



New HUMI-KUP 2-Set TV Coupler

ONLY
\$2.95
DEALER
NET



First hermetically sealed 2-set coupler in three models; HK1 for normal installation; HK2 for exceptional signal gain; HK3 for maximum interference rejection and FM-TV operation from one antenna.

Trolmaster and Kleontrol Solvent

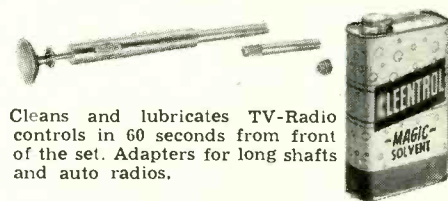

Cleans and lubricates TV-Radio controls in 60 seconds from front of the set. Adapters for long shafts and auto radios.

Write Today for Information on These Servicemen's Designed Products

R-Columbia PRODUCTS CO., INC. Highwood, Illinois

ABBREVIATIONS

(Continued)

- In radar, type of indicator which presents target azimuth, range and elevation data. Not in general use.
- Henry, the unit of inductance.
- h —Head.
- HD —High frequency (frequency band).
- hf —Height Indicator (radar).
- HI —Horizontal (side) Intermediate Distributing Frame (telephony).
- HIDF —High Fidelity (recorded sound).
- Hi FI —Hermetically sealed integrating Gyro.
- HIG —High-precision shoran.
- Hiran —Horizontal (side) Main Distributing Frame (telephony).
- HMDF —Horizontal.
- HORIZ —Horsepower.
- hp —Heater.
- HTR (H) —High voltage.
- HV
- I—
- I —Effective or rms value of current.
- In radar, type of indicator used with conical antenna scan. Presentation is circular and displays range and azimuth data. Not in general use.
- i —Instantaneous current.
- IA —Input axis (gyro).
- IAGC —Instantaneous Automatic Gain Control (radar).
- IBRL —Initial Bomb Release Line (radar navigation).
- IC —Internal connection (vacuum-tube base diagrams).
- ICAS —Intermittent Commercial and Amateur Service.
- ICBM —Intercontinental Ballistic Missile.
- ICW —Interrupted continuous wave.
- ID —Inside diameter.
- IDF —Intermediate Distributing Frame (telephony).
- if —Intermediate frequency.
- IFF —Identification of Friend or Foe (radar).
- ILAS —Instrument Landing Approach System.
- ILS —Instrument Landing System.
- IM —Intermodulation.
- Imp. —Impedance.
- IN —Input.
- INV —Inverter.
- iota (i) —Greek letter symbol for:
 - Unit vector.
 - Intermediate power amplifier.
- IPA —Inches per second.
- ips —Product of current (I) and resistance (R). Equal to voltage.
- IR —Product of current squared and resistance. Equal to power in watts.
- I²R
- IRBM —Intermediate Range Ballistic Missile.
- ITV —Industrial Television.
 - In vacuum-tube terminology:
 - Average or quiescent plate current.
 - Total peak plate current.
 - Quiescent (no-signal) plate current.
 - Average or quiescent grid current.
 - Rms value of varying component of grid current.
 - Rms value of varying component of plate current.
 - Maximum varying component of plate current.
- I_s —Total electron emission.
- ib —Instantaneous total base current.
- ibc —Instantaneous total collector current.
- ic —Instantaneous total varying component of grid current.
- ig —Instantaneous total varying component of plate current.
- i_p
- J—
- J —Symbol for Joule.
- In mathematics, square root of -1.
- In vectors, indication for counter clockwise rotation of 90°.
- Jack.
- In radar, type of indicator that presents target range data. Time bases circular and targets appear as radial pipes.
- Impedance-matching arrangement often used to match a half-wave resonant antenna to nonresonant transmission line.
- JAN —Joint Army-Navy (specifications).
- JANAP —Joint Army-Navy-Air Force Publications.
- K—
- K —Dielectric constant.
- Specific inductive capacity.
- Thousand.
- Symbol for constant; often Nagaoka's Constant.
- Kilo.
- Kelvin temperature.
- Band of radar frequencies extending from 11,000 to 33,000 mc.
- A type of X-ray radiation.
- Kappa (K, κ) —Greek letter symbol for:
 - Susceptibility.
 - Coupling coefficient.
 - Kilocycle.
 - Prefix meaning 1,000 times the unit.
 - Thousands of megacycles.
 - Kilovolt.
 - Kilovolt ampere.
 - Kilowatt.
 - Kilowatt hour.
- ke —Kilo
- kmc —Thousands of megacycles.
- KV —Kilovolt.
- KVA —Kilovolt ampere.
- kw —Kilowatt.
- KWH —Kilowatt hour.

TO BE CONTINUED

SAMS BOOKS
keep you ahead in
ELECTRONICS

SAMS books cover every phase of Electronics for the service technician, engineer, student or experimenter. Listed below are a few of the many valuable SAMS books available at electronic parts distributors and leading book stores.



2 NEW SAMS BOOKS

"ELECTRONIC METAL LOCATORS"

by
Harold S. Renne

Explains how Metal Locators operate, describes commercial types available, shows how to construct home-built units, describes applications. Fully analyzes the three basic types of Metal Locators: transmitter-receiver, beat-frequency and induction bridge. Includes chapter showing construction details for several different units, including transistorized types. Reveals the interesting applications of Metal Locators in industry. Special chapters are devoted to prospecting and mine detection applications. Includes valuable bibliography. 124 pages; 5 1/2 x 8 1/2"; illustrated. Order today, postpaid only. . . . \$2.50

"SCATTER PROPAGATION Theory & Practice"

by **Kamen & Doundoulakis**

An invaluable book not only for engineers but for technicians who will play an important part in the installation, operation and maintenance of scatter propagation systems. Covers theory and characteristics of Scatter Propagation; equipment used in ionospheric communications systems; tropospheric propagation and equipment utilized; design and construction of parabolic antennas; the importance of Scatter Propagation for the electronic technician; discusses DEW Line and other northern radar and scatter lines. Written so you can understand it. 204 pages; 5 1/2 x 8 1/2"; illustrated. Order today, postpaid only. . . . \$3.00

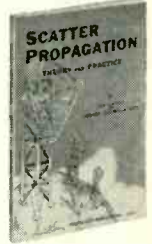

USE THIS ORDER FORM

ELECTRONIC METAL LOCATORS. \$2.50

SCATTER PROPAGATION. \$3.00

Color TV Training Manual. Prepares the Technician for Color TV service work. Covers principles of the Color TV system; Color receiver circuits; installation and servicing sets. Includes color blocks outlining the use of color test equipment. 260 pages; 8 1/2 x 11"; 300 illustrations. \$6.95

Tape Recorders—How They Work. Explains recording theory, tape characteristics, motorboard mechanisms, drive motors, amplifiers, magnetic heads, volume indicators, equalization circuits—covers everything you want to know about recorders. 176 pages; 5 1/2 x 8 1/2". \$2.75

TV Test Instruments. Revised and enlarged to include latest data on instruments used in Color TV servicing. Tells clearly how to operate each type of test instrument used in TV service work. 180 pages; 8 1/2 x 11"; illustrated. \$3.50

Servicing AGC Systems. Describes the operation and circuit variations of the various types of AGC systems and explains the servicing techniques that can be applied. Illustrated by actual case histories and photographs of symptoms. 132 pages; 5 1/2 x 8 1/2"; illustrated. \$1.75

Key Checkpoints in TV Receivers. Prepared by the Howard W. Sams engineering staff. Provides many applications for general TV service work, including time-saving information on how to make quick tests at key points to determine where trouble lies, and how to check overall performance of the receiver after repair, to insure against callbacks. 182 pages; 5 1/2 x 8 1/2"; illustrated. \$2.00

Servicing & Calibrating Test Equipment. Shows you how to keep your test instruments in reliable working order, how to determine proper operation and avoid erroneous indications. Explains calibration procedures; gives method for performance record-keeping; shows simple ways to check instrument accuracy; describes proper maintenance and servicing of instruments. 192 pages, 5 1/2 x 8 1/2". \$2.75

Servicing TV Sweep Systems. Describes the operation, circuit function and circuit variations of vertical and horizontal sweep systems common to most TV receivers. Tells how to analyze circuits; trouble-shoots for you. 212 pages; 5 1/2 x 8 1/2"; illustrated. \$2.75

So You Want to Be a Ham. Tells you what you need to know about getting your license and acquiring equipment. Covers such subjects as: Conquering the Code; Getting Your Ticket; Going on the Air; Electronics as a Career; etc. 196 pages; 5 1/2 x 8 1/2"; illustrated. \$2.50

Radio Receiver Servicing. Covers the basic receiver types—gives time-saving hints for solving basic troubles, such as dead set, weak set, noisy set, etc. 192 pages; 5 1/2 x 8 1/2". \$2.50

TV Servicing Guide. Explains how to apply proper trouble-shooting procedures based on analysis of symptoms (most of which are illustrated by picture-tube screen photos). Shows how to locate and eliminate trouble in every section of the receiver. 132 pages, 8 1/2 x 11". \$2.00

There is an authoritative Sams book on virtually any Electronic subject in which you're interested. Check below for FREE Book List describing all Sams books.

Send Book List



...HOWARD W. SAMS & CO., INC.

Order from your Parts Jobber today, or mail to Howard W. Sams & Co., Inc., Dept. 2-M-6 2201 East 46th St., Indianapolis 5, Indiana.

Send books checked above. My (check) (money order) for \$ is enclosed.

Name

Address

City Zone State

(outside U.S.A. priced slightly higher)

Look for **SAMS BOOKS** on the "Book Tree" at your **Parts Distributor**

ONE DOLLAR BUYS

As much as \$15 worth—Everything Brand New and sold to you with a money back guarantee.

- 100—ASSORTED 1/2 WATT RESISTORS.....\$1
- 70—ASST. 1 WATT RESISTORS.....\$1
- 35—ASST. 2 WATT RESISTORS.....\$1
- 100—FUSES 1 AMP standard size 1 3/4" x 1/4".....\$1
- 100—TUBULAR CONDENSERS .02—100v.....\$1
- 100'—FINEST NYLON DIAL CORD.....\$1
- 200—SELF TAPPING SCREWS #8 x 3/8".....\$1
- 400—ASST. SCREWS, NUTS, WASH, RIVETS.....\$1
- 50—ASST. TUBULAR CONDENSERS 850.....\$1
- 35—ASST. RADIO KNOBS screw and push-on.....\$1
- 100—KNOB SPRINGS standard size 3/8" x 1/4".....\$1
- 50—ASST. SOCKETS octal and miniature.....\$1
- 50—ASST. MICA CONDENSERS some in 5%.....\$1
- 50—ASST. CERAMIC CONDENSERS.....\$1
- 10—ASST. VOLUME CONTROLS less switch.....\$1
- 5—ASST. VOLUME CONTROLS with switch.....\$1
- 20—ASST. PILOT LIGHTS #44, 46, 47, 51.....\$1
- 10—PILOT LIGHT SKTS. bayonet type, wired.....\$1
- 50—ASST. TERMINAL STRIPS 1, 2, 3, 4 lug.....\$1
- 10—ASST. RADIO ELECTRO. CONDENSERS.....\$1
- 5—ASST. TV ELECTROLYTIC CONDENSERS.....\$1
- 10—ASST. TV COILS sonic, peaking, width, etc.....\$1
- 10—6 FT. ELEC. LINE CORDS with plug.....\$1
- 5—TV CHEATER CORDS with both plugs.....\$1
- 200'—HOOK-UP WIRE & SOLDER KIT.....\$1
- 100'—TWIN LEAD-IN WIRE 300Ω heavy duty.....\$1
- 50'—FLAT 4-CONDUCT. WIRE, many purposes.....\$1
- 10—AC-DC ANTENNA HANKS each 20 feet.....\$1
- 25—ASST. MICA TRIMMER CONDENSERS.....\$1
- 50—TUBULAR CONDENSERS .1-200v.....\$1
- 50—TUBULAR CONDENSERS .02-400v.....\$1
- 50—TUBULAR CONDENSERS .001-600v.....\$1
- 25—TUBULAR CONDENSERS .01-600v.....\$1
- 20—TUBULAR CONDENSERS .25-600v.....\$1
- 20—TUBULAR CONDENSERS .047-600v.....\$1
- 20—TUBULAR CONDENSERS .001-1000v.....\$1
- 20—TUBULAR CONDENSERS .01-1000v.....\$1
- 3—ELECTROLYTIC COND. 50/30 .150v.....\$1
- 5—ELECTROLYTIC COND. 100/50 .50/25v.....\$1
- 3—ELECTROLYTIC COND. 80/50 .450v.....\$1
- 3—ELECTROLYTIC COND. 40/10/10 .450v.....\$1
- 3—ELECTROLYTIC COND. 40/40 .450v.....\$1
- 5—ELECTROLYTIC COND. 250/1000 .10/8v.....\$1
- 20—10KV CARTWHEEL COND. total list \$35.....\$1
- 35—MICA COND. 20-30 mmf & 15-100 mmf.....\$1
- 35—MICA COND. 20-470 mmf & 15-100 mmf.....\$1
- 35—MICA COND. 20-3000 mmf & 15-10K mmf.....\$1
- 35—CERAMIC COND. 20-1 mmf & 15-47 mmf.....\$1
- 35—CERAMIC COND. 20-88 mmf & 15-1500 mmf.....\$1
- 35—CERAMIC COND. 20-2500 mmf and 15-680 mmf.....\$1
- 10—ASST. WIREWOUND RES. 5, 10, 20 watts.....\$1
- 50—100Ω 1/2 WATT RESISTORS 5%.....\$1
- 75—680Ω 1/2 WATT RESISTORS 10%.....\$1
- 75—470KΩ 1/2 WATT RESISTORS 10%.....\$1
- 50—3.3Ω 1 WATT RESISTORS 10%.....\$1
- 50—3900Ω 1 WATT RESISTORS 10%.....\$1
- 50—15KΩ 1 WATT RESISTORS 10%.....\$1
- 50—27KΩ 1 WATT RESISTORS 10%.....\$1
- 50—120KΩ 1 WATT RESISTORS 10%.....\$1
- 50—150KΩ 1 WATT RESISTORS 5%.....\$1
- 50—470KΩ 1 WATT RESISTORS 10%.....\$1
- 50—2.2 MEGΩ 1 WATT RESISTORS 10%.....\$1
- 25—2.2Ω 2 WATT RESISTORS 5%.....\$1
- 25—3.3Ω 2 WATT RESISTORS 5%.....\$1
- 25—270Ω 2 WATT RESISTORS 10%.....\$1
- 25—470Ω 2 WATT RESISTORS 10%.....\$1
- 25—100KΩ 2 WATT RESISTORS 10%.....\$1
- 3—AUDIO OUTPUT TRANSFORMERS 5016 type.....\$1
- 3—AUDIO OUTPUT TRANS. 9K6 or 6V8 type.....\$1
- 3—I.F. COIL TRANSFORMERS 456kc.....\$1
- 3—I.F. COIL TRANSFORMERS 10.7 mc FM.....\$1
- 4—OVAL LOOP ANTENNAS ass't. hi-gain types.....\$1
- 3—LOOPSTICK ANT. new to date, adjustable.....\$1
- 12—RADIO OSCILLATOR COILS 456kc.....\$1
- 3—1/2 MEG VOLUME CONTROLS with switch.....\$1
- 1—BEST 4" PM SPK. 1.47 oz. alnico #5 magnet.....\$1
- 1—5" PM SPEAKER alnico #5 magnet.....\$1
- 2—\$2.50 SAPPHIRE NEEDLES 4000 playings.....\$1
- 2—SELENIUM RECTIFIERS 1-65ma. 1-100ma.....\$1
- 5—DIODE CRYSTALS 2-IN21 2-IN23 1-IN64.....\$1
- 100—ASSORTED WHITE TUBE CARTONS.....\$1
- 300—TV STANDARD CORONA BUTTONS.....\$1
- 300—TV DIAL ESCUTCHEON SPRINGS.....\$1
- 1—\$6 INDOOR TV ANTENNA hi-gain 3 section.....\$1
- 1—21" TV OPEN MASK soft gray color.....\$1
- 1—TV SAFETY GLASS 13 3/8" x 16 1/2".....\$1
- 1—TV UNIV. FOCALIZER adjusts for any ohmage.....\$1
- 1—TV VERT. OUTPUT TRANS. 10 to 1 ratio.....\$1
- 5—TV CRT. SOCKETS with 18" leads.....\$1
- 5—HI-VOLT. ANODE LEADS with 18" leads.....\$1
- 1—\$3 CRT BOOSTER new life to old tubes.....\$1
- 2—TV 1ST & 2ND SND. I.F. COILS #201K1.....\$1
- 1—TV SYNCHROGUIDE TRANSFORMER #205R1S1.....\$1
- 1—TUNER TAKE-OFF COIL #XM-752.....\$1
- 1—TV RATIO DETECTOR TRANS. 4.5mc.....\$1
- 1—SET TV KNOBS standard type incl. decals.....\$1
- 1—LATEST GOLD GRILL CLOTH 12" x 18".....\$1
- 1—LB SPOOL ROSIN CORE SOLDER 40/60.....\$1
- 6—SPIN TIGHT SOCKET SET 3/16" to 7/16".....\$1
- 3—TV ALIGNMENT TOOLS 7", 12", 18".....\$1

HANDY WAY TO ORDER—Simply tear out advertisement and pencil mark items wanted, enclose with money order or check. No letter needed, envelope address is sufficient. You will receive a new copy of this ad for re-orders.

ON SMALL ORDERS—Include stamps for postage, excess will be refunded. Larger orders shipped express collect.

BROOKS RADIO & TV CORP.
84 Vesey St. New York 7, N. Y.



Note: Records below are 12-inch LP and play back with RIAA curve unless otherwise indicated.

HANDEL: Suite from the Water Music
(Arranged by Harty)
Pro Arte Orchestra conducted by Macklin Marrow

CIMAROSA: La Cimarosiana
(Arranged by Malipiere)
ROSSINI: Soirées Musicales
(Arranged by Britten)
Royal Opera House Orchestra
conducted by Warwick Braithwaite
MGM E-3333

All of this is interesting music, the Handel far more familiar than the rest. Unfortunately, the Handel is distorted in spots, though the other side is very good and may well be worth the price alone because these works are seldom heard. The Britten rewriting of themes from Rossini is most interesting for its instrumentation. *La Cimarosiana*, a suite based on fragments of Cimarosa's music, is simple, pleasant music. There are some nice high highs in the larghetto and a lovely dull drum in the vivace, which is first-class demonstration material.

BRAHMS: Second Symphony
Schmidt-Isserstedt conducting
N. W. German Radio Symphony
Orchestra
Capitol P-18000

BEETHOVEN: Symphony No. 3
(Eroica)
Steinberg conducting
Pittsburgh Symphony
Capitol P-8334

Two samples of the new opulence in the sound of the standard classics, the movement away from the exaggerated high and low ends toward a better balance and higher presence. I don't know just how well these versions compare in musicianship with others and won't venture any judgments; but those die-hards who have objected to hi-fi on the score that the hi-fi jinks submerged or profaned the music, should be convinced by these that good sound can enhance the musical values.

SURINACH: Doppie Concertino for Violin, Piano and Chamber Orch.
CHAVEZ: Sonatina for Violin and Piano

REVUELTAS: Three Pieces for Violin and Piano
Mare and Anahid Ajemian, soloists
Chamber Orchestra conducted by Surinach
MGM E-3180

Having uncovered pay dirt in previous works of the above Spanish and Spanish-American composers, MGM has wisely continued working the mother lode. This particular set is not for popular consumption but the musically sophisticated will find it an unusually rewarding test record-

ing. The *Concertino* is the most tolerable to the classical ear but not nearly as much so as the previously recorded works of Surinach. It has some really remarkable tonal effects and some very subtle and sophisticated ones. The simplest sample is a passage in which the clarinet and piccolo play in unison to provide a complex so thoroughly united that it will take good definition to recognize the pairing. The others are far more difficult to account for and it will take both a system with highly exceptional definition and a well-trained ear to recognize them and to figure out how they are achieved. The high highs are very individual. There are plenty of percussives. And some passages present a most severe test for wow. The *Sonatina* is modern dissonance of highly advanced degree. If you can tolerate it at all your system is more than acceptably free of distortion. I warn those who demand pleasant sounds to stay away from this. But you who can tolerate dissonance should find this most interesting and valuable as test material.

CARR, Michael: Springtime Suite
MGM E-3296
WEIL, Kurt: Favorites
MGM E-3323

Richard Ellsasser at organ of Hammond Museum
If you don't want to present your system with a severe challenge or if you prefer more popular organ music, either or both of these discs will do. Nothing here to phase any good hi-fi system but lots of good tuneful music in interesting organ-izations. The Weil record has the more familiar music, including one of my prime favorites, the *September Song*.

GRIEG: Lyric Suit
Norwegian Dances
Wedding at Troldhaugen
Holberg Suite
Remoortel conducting
Bamberg Symphony
Vox PL-9840

Vox is getting some lovely sound, from the Bamberg Symphony and this disc should appeal especially to those who are just entering the world of serious music. Nothing really startling but fine sound, well balanced, with a good bass, lovely flutes, nice liveness and a fine clean sound throughout.

Don Elliott Doubles in Brass
Vanguard VRS-8016 (10-inch MG)
A jazz record with amazing presence. Don Elliott plays his normal vibraphone plus the trumpet and mellophone, with piano, bass and drum accompaniment, in a sort of modernized "swing" style.

Tony Mottola, His Guitar and Orchestra
MGM X-300 (Two 45-r.p.m. extended play)

Tony Mottola is one of the best jazz guitarists in the business and these records provide some lovely sound with plenty of guitar transients and Latin American noise makers besides. It will do no harm whatever to the attractiveness of any system it is played on. Very clean for a pop-

HIGH POWER **LOW POWER** **AC POWER** **DC POWER**

POWER-LAB

BY **precise** OPERATES YOUR WHOLE BENCH & SHOP

KIT
OR
WIRED

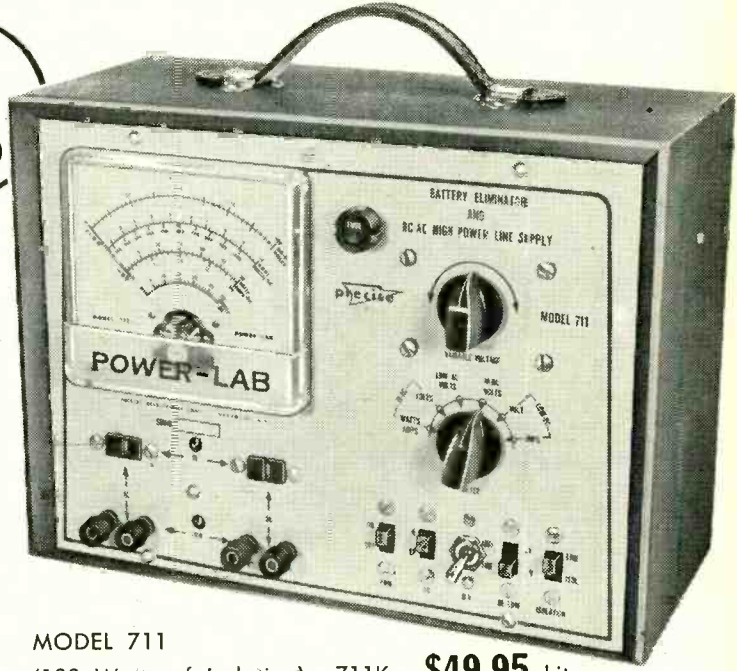

YOU'LL START AND END EACH WORKING DAY WITH THE POWER-LAB

For the first time in the industry, one instrument takes the place of more than 11 pieces of equipment and makes you wonder why no one ever did this before . . . the most useful, often used, test device in your shop.

Here's the story . . . now, you can get all this COMPLETE IN ONE KIT (kit or wired):

- ★ A BATTERY ELIMINATOR
- ★ A BATTERY CHARGER
- ★ A HIGH CURRENT LINE VOLTAGE VARIAC
- ★ AN AC LINE VOLTAGE METER
- ★ AN AC LINE AMMETER
- ★ AN AC LINE WATTMETER
- ★ AN AC LINE ISOLATION TRANSFORMER
- ★ A LOW VOLTAGE, HIGH CURRENT AC SUPPLY
- ★ A DC LINE VOLTAGE VARIABLE SUPPLY
- ★ A DC HIGH CURRENT AMMETER
- ★ AN AC BIAS BOX

MODEL 711
(100 Watts of Isolation) 711K — \$49.95 kit
711W — \$64.95 wired

MODEL 713
(300 Watts of Isolation) 713K — \$62.95 kit
713W — \$79.95 wired

When you buy POWER-LAB by Precise, you get all the advantages of owning a battery eliminator for servicing auto radios (even signal seekers), an AC-DC Converter, a supply for transistor sets, and of MAINTAINING A CONSTANT 115 volts in checking on TV set variations. You can even run the set down to 105 volts for testing for horizontal jitter and back up to 125 volts for high voltage breakdown, thereby eliminating the cause of many call-backs due to arcing . . . PLUS

. . . PLUS . . . PLUS . . . the 101 uses you'll find each day for POWER-LAB versatility.

Just look at these specs . . . the switches used are more than ample to carry related loads required and the quality of every component is EXCELLENT. You could easily pay three to four times the price of the POWER-LAB for the equipment to perform only a few of the functions of the POWER-LAB!

ALL SPECS BELOW ARE FOR MOD. 711 AND 713 UNLESS OTHERWISE SPECIFIED

	VOLTS	MAXIMUM	CONTINUOUS
Low Voltage DC	2 ranges 0-15v Full Wave 0-30v Full Wave Bridge	20 amps* 20 amps*	10 amps* 10 amps*
Low Voltage AC	0-24v		20 amps
High Voltage AC	No Isolation 90-140 volts	20 amps 2000 watts	10 amps 1000 watts
High Voltage AC	Model 713 with Isolation 90-140 volts		3 amps 300 watts
High Voltage AC	Model 711 with Isolation 90-140 volts		1 amp 100 watts
High Voltage DC	110-180 volts	1 amp**	.075 amp**

*Depending on voltage.
**May be increased up to 10 amperes at additional cost.

There's NO OTHER INSTRUMENT LIKE THE POWER-LAB ON THE MARKET. Here again, Precise engineering is proud to be the first to supply a need that has too long existed in the service trade.

Your Distributor will be proud to show you THE POWER-LAB

Prices slightly higher in the West. Prices and specifications subject to change without notice.

WRITE FOR CATALOG RE 12-6

SEE THE MANY MORE PRECISE INSTRUMENTS AND PROBES AT YOUR DISTRIBUTOR TODAY!

precise DEVELOPMENT CORP. OCEANSIDE, NEW YORK, U.S.A.

Here's why



tubular capacitors give you better performance and longer life!

All Aerovox P88N molded tubular capacitors are manufactured by a unique low-pressure, low-temperature molding process that insures perfectly centered sections with uniform wall thickness on every single unit. Only Aerovox gives you round, uniform, undistorted, coaxially-centered sections solidly imbedded in the right plastic for superb mechanical, electrical and climatic characteristics.

NOT THIS NOR THIS AND NEVER THIS



Off-centered section



Distorted section



Compressed section

BUT
Always
THIS 

Perfectly centered, undistorted, unimpaird section protected by uniform and adequate plastic wall thickness.

That's the inside story why Aerovox Duranite capacitors are recognized for their top performance and utmost reliability and extra-generous service life. Your local Aerovox Distributor carries a complete stock of Aerovox capacitors to meet ALL your service needs. Drop in soon and ask for a copy of the latest Aerovox catalog or write



AEROVOX CORPORATION

DISTRIBUTOR SALES DIVISION,
NEW BEDFORD, MASS.

In Canada: AEROVOX CANADA LTD., Hamilton, Ont.
Export: Ad Auriema, 89 Broad St., New York, N. Y.,
Cable: Auriema, N. Y.

NEW RECORDS

(Continued)

Pop Parade Vol. 5

MGM X-313 (Two 45-r.p.m. extended play)

If you like to keep a running recorded catalog of the pop hits of the times, I can recommend this series highly. The quality is much better than on the original pop releases, with none of the usual overcutting which makes most pops sound so horrible on wide-range systems.

Calypso

Harry Belafonte

RCA Victor LPM-1248

The simplest way to demonstrate naturalness and presence is with a fine voice recording—though few are familiar with the natural sounds of musical instruments, everyone knows what voices sound like. If, in addition to a good natural voice, the recording possessed a fine bass and a few samples of high high tinkling and if the musical content appealed to most people, we would have a most useful recording. Unfortunately most vocal recordings fail in one or more ways to meet these criteria. If the voices are operatic or concert types, they suffer from the artificiality of each style; if they are popular artists, the recordings almost invariably suffer from overcutting with a consequent high distortion which is very annoying on fine hi-fi systems. Here, however, is a recording which avoids the vices and possesses most of the listed virtues.

Belafonte's highly expressive voice is presented with impressive presence, intimacy and naturalness. The accompanying band includes a fine dull bass and a few touches of Latin American high highs. The overall effect should impress with its intimate naturalness and high degree of presence on a fine system, particularly since the Calypso songs have a high appeal even to the more sophisticated musical taste.

The Wayfarers

RCA Victor LPM-1213

This lacks both the deep bass and the high highs, and therefore the all-around demonstration value of the above, but the voices share the same naturalness and presence. Those who like folksongs and do not require that they be sung by "primitive" voices will also like these very smooth but relatively unaffected renditions of 17 folksongs from all over the world, including the American *Birmingham Jail*, *Old Paint*, *Wayfaring Stranger* and many from other lands.

Glowing Embers,
Liane

Vanguard VRS-7034

While we're speaking of vocals, we must add this latest discing of the cosmopolitan *Liane*, which, like the previous ones, is very clean and with a strikingly intimate presence. This has some 14 continental songs in English, French and German and has the real Viennese *gemutlichkeit* sentimentality.

Dictograph High-Fidelity Demonstration
EB-2986

Produced by Capitol for the Dictograph Co. to demonstrate their line of hi-fi systems, much of the material is excerpted from Capitol's own demonstration recordings (though there are two or three excerpts from the general catalog) and the quality is about the same, though in some selections the high highs seem more exaggerated here than in the originals. The music is sandwiched between copious slices of hammed-up commentary, aimed apparently at selling customers who are completely innocent of any knowledge of high fidelity, good music and good sound. For any one even the slightest degree more sophisticated I would suggest the original Capitol or other test recordings without commentary—even when selling the Dictograph line. Not for general sale, this recording is distributed by Dictograph to its dealers only.

MOZART: *Haffner Serenade in D Major, KV250*

Woldike conducting Vienna State Opera Orchestra

Vanguard VRS-483

Another seldom-heard work of Mozart, portions of this long and ambitious serenade were later used by him as the basis for the *Haffner* Symphony. This recording includes the march orig-

the **BEST** because . . .
Only the CLEAR PICTURE Comes Thru!



with the NEW and AMAZING *Dynamic* FILTER TENNA

with the EXCLUSIVE built-in HI-PASS FILTER
T. M. Reg. Pat. Pend.

THE FIRST TRULY ELECTRONIC INDOOR TV ANTENNA TO GIVE CLEAR FILTERED RECEPTION.

Just \$18.95

SATIN BRASS, SATIN CHROME, SATIN COPPER FINISHES.



Beautiful!

The secret is in the filter! Automatically screens out electrical disturbances. Ghosts, fuzz, and distortion eliminated with a 12 position channel attenuator. Guaranteed to outperform all other indoor antennas, and most roof installations in urban areas . . . or money back!

ALSO, there is a DYNAMIC accessory or service aid for practically every need.



MODEL DF200 \$9.50 LIST

Available at all distributors where quality electronics are sold.
COMPLETE LINE FOLDERS ON REQUEST!

Manufactured By . . .
DYNAMIC ELECTRONICS - NEW YORK, INC.
Forest Hills, Long Island, New York

inally played in advance of the *Serenade* itself and a more ambitious scoring and orchestration than is usually employed. The sound is fully up to the previous Vanguard recordings of this orchestra, though the music does not provide as spectacular material as Straus waltzes, polkas, etc. It is pleasant and should please.

KARL-BIRGER BLOMDAHL: *Chamber Concerto for Winds, Percussion and Piano*

RICHARD DONOVAN: *Soundings for Trumpet, Bassoon and Percussion*

JOHN VERRALL: *Prelude and Allegro for Strings*

Carl Surinach conducting MGM Chamber Orchestra

MGM E-3371

I don't know why MGM is taking the lead in presenting *avante garde* modern music, but I for one welcome it. I believe that this recording will also be welcomed by those interested in the experimental new music and those who would like a little music (even though of very non-conventional style) with their percussion. The Blomdahl and Donovan works are especially recommended for their remarkable blending of highly unusual instrumental tone and orchestral color and the fine sharp definition of percussion. The mid-bass especially gets a nice going over, what with the bassoon and the tympani in their mid and high registers, and the counterpoint of various other percussion instruments including marimba, xylophone, cymbals, blocks, gongs, tambourine, etc., very nicely reproduced. Because the group is rather small the presence in a living room is high and the sound is very real.

POULENC: *Concerto for Organ, Strings and Tympani*

HANSON: *Concerto for Organ, Strings and Harp*

Richard Elsasser, organist
Arthur Winograd conducting
Philharmonia Orchestra of
Hamburg

MGM E-3361

MGM offers also this similarly novel and extraordinary coupling of instruments. The Poulenc concerto has some especially notable effects, particularly the unison coupling of drums and organ pedal, and Poulenc's music is both less *avante garde* and more listenable for the music itself. The Hanson concerto, though it is not as piquant musically and—without the tympani—does not produce as novel a sound, is also highly palatable.

These two discs, incidentally, are the first with the new MGM treatment against static. Just what treatment is used, MGM sayeth not, but its effectiveness is evident in the very first playing. Ordinarily the first playing of a new record—without some treatment—results in the pickup needle getting thoroughly fouled before halfway across the disc. On these, it remained clean—and the music, in consequence, unusually clean and sharp—throughout the first and subsequent playings. All hail to MGM not only for its boldness in music but for this exciting precedent.

Amparo Iturbi Plays

RCA Victor LM-1075

Amparo Iturbi, sister of the more famous Jose, plays a very nice piano indeed and this recording of Ravel's *Vaises Noble and Sentimental*, Chabrier's *Scherzo-Valse, Idylle and Bourree Fantastique*, under her delicate and expressive hands produces a very pleasant sound and offers a good example of good modern piano.

Mexico

Pablo Flores, pianist

MGM E-3312

This is MGM's entry into the tea room and high-check restaurant mood piano-player sweepstakes. Every label has at least one and you can say for Flores that he doesn't do the obvious; some of his renderings will steal your attention from the olive in the bottom of the glass. Pretty good piano and pleasant, mildly different "concert" versions of favorite Mexican tunes, including the *Hat Dance, La Paloma*. END

Name and address of any manufacturer of records mentioned in this column may be obtained by writing Records, RADIO-ELECTRONICS, 154 West 14th St., New York 11, N.Y.

The 7 Old-Fashioned Villains of Tape Recording

...and How

irish FERRO-SHEEN
BRAND

Foiled Them All

Once upon a time, 7 Old-Fashioned Villains like this  were wreaking endless woe on Decent People with Tape Recorders. The 1st Villain was Oxenscheid the

Oxide Shedder.  He scraped away at the crumbly oxide coating of old-fashioned tape and gummed up tape recorders with the shedding particles. The 2nd

Villain was Wearhead the Head Wearer.  He filed down the magnetic heads with the abrasive coating of old-fashioned tape. The 3rd Villain was Frickenshaw the

Frequency Discriminator. He dragged down  the high-frequency response of old-fashioned tape through inadequate contact between the "grainy" coating

and the head. The 4th Villain was Noysenhiss the Noise Generator. He generated tape hiss and modulation noise  as a result of the random vibrations and

irregular flux variations caused by the uneven magnetic coating of old-fashioned tape. The 5th and 6th Villains were Dropofsky the Drop-Out Artist and Pringlethorpe the

Print-Through Bug.  They put nodules and agglomerates into the oxide emulsion of old-fashioned coated tape, causing "drop-outs" whenever these trouble

spots lost contact with the record or playback head, and inducing "print-through" on the recorded tape when the extra flux at the trouble spots cut through adjacent layers on the

reel. The 7th Villain was Brattleby the Embrittler.  He dried out the plasticizers in old-fashioned coated tape and embrittled irreplaceable recordings.

Then... **OCTOBER, 1954!** That's when a very un-old-fashioned little man  by the name of F. R. O'Sheen announced that he had developed the revolutionary new

irish FERRO-SHEEN process of tape manufacture and presto!.. the 7 Old-Fashioned Villains were  sent a-scurrying with cries of

"Confound it—Foiled again!" Yes, F. R. O'Sheen had made the new magnetic oxide lamination of **irish FERRO-SHEEN** tape so smooth-surfaced and non-abrasive, so firmly

anchored and homogeneously bonded to the base, so free from nodules and agglomerates, that the 7 Villains were evicted

—for good! **Moral:** Don't let Old-Fashioned Villains do you out of your hi-fi rights!  Just say "No, thanks"

to ordinary coated tape  and ask for F. R. O'Sheen — **irish FERRO-SHEEN**, that is! ORRadio Industries, Inc., Opelika, Alabama.





on your newsstand, DECEMBER 27

Just a few of the outstanding features in this big issue

- ✓ Most Useful Schematics of 1956-1957
- ✓ TV Station List
- ✓ How the Apple Color Tube Works
- ✓ Black and White Adjustments in Color TV
- ✓ Get Acquainted With Color TV
- ✓ TV Shop on Wheels
- ✓ Features by Middleton, Mandl, Colgate, Crowhurst and others
- ✓ Plus other articles on radio, audio, transistors.

Don't miss RADIO-ELECTRONICS
10th Annual Television Issue. Reserve your copy now.

SUBSCRIBE NOW AND SAVE

Effective January 1, 1957 subscription rates will be raised. Until that date you can still subscribe at the old rates — One year \$3.50, Two years \$6.00, Three years \$8.00. If you act now, we will include the January Television issue in your subscription.

RADIO-ELECTRONICS • 154 West 14th St., New York 11, N. Y.

new Devices



EXPANDED-SCALE VOLTME-TER, Custom Panel Meter. Up to 10 times greater readability. Scale used most expanded 90-130 volts ac rms. Either ac or dc.

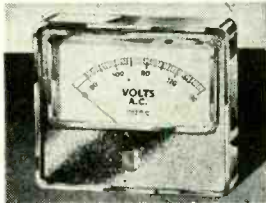

Wide variety ranges and case styles.—Phaotron Instrument & Electronics Co., 151 Pasadena Ave., S. Pasadena, Calif.

MOISTURE METER, Moistur-ometer. Transistorized. 0-100- μ a microammeter. Accuracy 5% at 70°F for materials for which it has been calibrated. 0-100



empirical scale for adaptation to special materials. 6 $\frac{1}{4}$ x 3 $\frac{3}{4}$ x 2 $\frac{3}{4}$ inches. 1 $\frac{1}{2}$ pounds.—Henry Francis Parks Lab., 104 S. E. 57th Ave., Portland 15, Ore.

MULTIPURPOSE FLYBACK-ER, model 382. In-circuit horizontal system analyzer and capacitor checker. Checks entire TV horizontal deflection system. Measures capacitances from 10 μ uf to 0.1 μ uf. Can be used as continuity meter and compares flyback transformers and deflection yokes for relative Q. 4 $\frac{1}{2}$ -



inch microammeter with 60-microamp full-scale sensitivity. 7 $\frac{1}{4}$ x 8 x 11 $\frac{3}{8}$ inches. 8 $\frac{3}{4}$ pounds. Special test cable included.—Simpson Electric Co., 5200 W. Kinzie St., Chicago 44, Ill.

MULTITESTER, Redi-Tester,

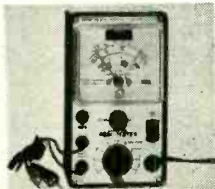

model 540. Multirange ac/dc voltmeter, ammeter, ohmmeter, wattmeter and leakage checker. 3 $\frac{1}{2}$ -inch meter. Voltage ranges 0-7.5, 15, 150, 300. Current range 0-15 amps. Direct-reading scale 0-1,000 ohms. Neon lamp ac leakage test circuit. Panel outlet meters current drawn by appliance.—EICO, 84 Withers St., Brooklyn 11, N. Y.

OSCILLOSCOPE KIT, Model O-11. For color TV. Built-in peak-to-peak calibrating source, step-attenuated input. Modern etched-circuit boards cut assembly time, prevent errors and stabilize circuit. Push-pull vertical



and horizontal output amplifiers. Response down 1 $\frac{1}{2}$ db at 3.58 mc. 5UP1 C-R tube in 11-tube circuit. 20 cycles to above 500 kc in 5 steps.—Heath Co., Benton Harbor 20, Mich.

TEST EQUIPMENT, LSG-10 signal generator. Frequency range of 120 kc to 260 mc, to 130 mc on fundamentals. LC-4 C.R. Tester with 4 direct-reading scales from .00001 to 1,000 μ f. 2 resistance ranges from 100 μ f to 5 megohms. LC-15 Capacitance-Resistance Checker for opens, shorts, leakage and

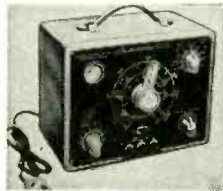

intermittents. Ranges from .00001 to 1,000 μ f and from 100 ohms to 5 megohms.—Lafayette Radio, 100 6th Ave., New York 13, N. Y.

TROUBLE FINDER, Monitron. Kit form or completely assembled. Monitors two circuits simultaneously, traces signal

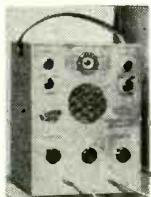

paths and makes point-to-point gain measurements without operator's attention.—Seco Mfg.

I'll Be
DOG-GONE!
YOU CAN SAVE MORE
AND SERVICE BETTER
with **EMC**

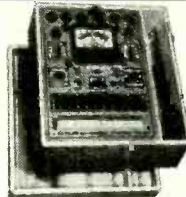

MUTUAL CONDUCTANCE TUBE TESTER — EMC Model 206 P

One of the finest pieces of tube testing equipment at a price comparing favorably with emission-type testers. This completely flexible model using lever-type switches offers extremely accurate results with ease of operation.

\$83.50 (hand rubbed carrying case)

VOLT-OHM-CAPACITY METER — EMC Model 107

Directly measures capacity, resistance and complex waveforms peak to peak. Some of the high quality features at no extra cost are: expanded scale cannot burn out . . . measures 50 mmfd to 5000 mfd . . . inductance from 1.4 henries to 140,000 henries in 4 ranges . . . 1% multipliers for voltage capacity and resistance measurements. \$48.90 wired & tested \$34.50 kit form



TRANSISTOR CHECKER EMC Model 210

New economical transistor checker contains these high quality features:

- Checks all PNP and NPN transistors
- Measures gain in three ranges
- Measures leakage on two color "Poor - Good" Scale
- Housed in a molded bakelite case
- Supplied complete with batteries

\$10.95 wired and tested
\$ 7.95 kit form

New White Dot-Cross Hatch — Bar Generator EMC Model 800

Lowest priced, quality color and monochrome generator available . . . easily adjusts color convergence, width, linearity, ion trap and yoke, etc.

\$39.90 wired and tested
\$22.50 kit form

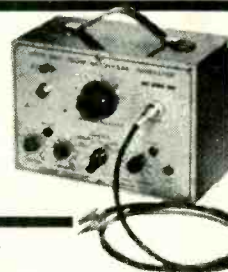

Wide Band Oscilloscope For Color And Monochrome TV EMC Model 601

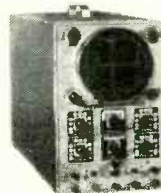

EMC Model 601 oscilloscope gives you the highest quality features ever found in this price field. Exclusive features: full 5 mc bandwidth for color TV servicing — push-pull vertical amplifier, .02 volt per inch sensitivity — 5 UPI — 5" scope tube — 60 cycle phasing control — DC positioning controls eliminates overshooting and bounce — built-in peak to peak calibration reference — 2-step compensated attenuator input — multi-vibrator sweep, from 15 cycles to over 75 kilocycles. \$117.90 wired and tested

Yes, I want to see for myself, send me—FREE—a detailed catalog of the complete EMC line of precision test equipment.

NAME _____ RE-12

STREET _____

CITY _____ STATE _____

EMC ELECTRONIC MEASUREMENTS CORPORATION
280 LAFAYETTE STREET, NEW YORK 12, N. Y.
EXPORT DEPT. - 370 BROADWAY, N. Y. 13, N. Y.

Co., 5015 Penn Ave. S., Minneapolis, Minn.

VACUUM-TUBE VOLTMETER, Anchor V 500-VTVM. 3-volt ac, zero centering for TV and FM alignment and 30-cycle to 100-megacycle range. Polarity reverse switch, db scale. With test

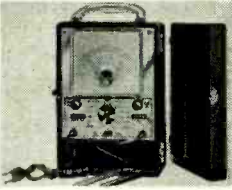

leads and isolation probe.—Anchor Prods. Co., 2712 W. Montrose Ave., Chicago 18, Ill.

TRANSISTOR RADIO KIT. Uses 2 penlight cells. Printed circuit, matched transistors, diode, loopstick, unbreakable gray plastic



case and 16-page instruction book.—Superex Electronics Corp., 4 Radford Pl., Yonkers, N. Y.

SILICON RECTIFIER STACKS. 600 volts. For power applications requiring high ambient

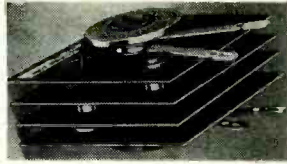

temperature and miniaturization. In all circuit types with rms inverse voltage ratings of 70, 105, 140, 210, 280, 350 and 420 volts, with dc output currents up to 4.5 amps at 75°C ambient temperature. Can be arranged in series and parallel. Hermetically sealed.—International Rectifier Corp., El Segundo, Calif.

VARIABLE VOLTAGE TRANSFORMER. 120 volts input, 1.25 amps maximum output current. PA-1 for 0-132 volts output and 165-va load rating; PA-1L 0-120 output and 150-va load rating.

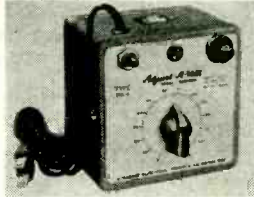

3 3/4 x 3 3/4 x 3 1/2 inches.—Standard Electrical Prods. Co., 2240 E. 3rd St., Dayton, Ohio.

ANTENNA, Wonder-Helix Colortenna. Two 600-ohm double-driven folded dipoles phased for maximum signal addition. In-line Yagi type construction.

Maximum back rejection. Front-to-back ratio more than 10 to 1 on all low-band channels, up to 14 to 1 on high band. All-

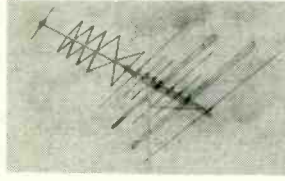

aluminum, boom-braced with 1-inch tubing.—JFD Mfg. Co., Inc., 6101 16th Ave., Brooklyn 4, N. Y.

ANTENNAS, Topliner series. Color and black-and-white transmission. Built around new antenna-connecting delay line network that maintains optimum impedance match to transmission line and single-lobe pattern throughout vhf band. Topliner '40 (Cat. 2540) with 3 working elements on low band and 9 on high for metropolitan and suburban installations. Topliner '50 (Cat. 2550) with 5 working elements on low band and 10 on high for suburban and near-fringe areas where lower-gain antennas are usually

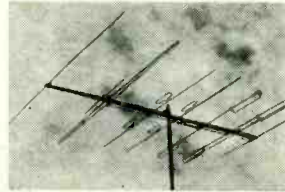

stacked. Topliner '60 (Cat. 2560) for fringe installations with 6 working elements on low band and 13 on high. Topliner '70 (Cat. 2570) with 8 working elements on low band and 19 on high for extreme-fringe installations.—Technical Appliance Corp., Sherburne, N. Y.

ANTENNAS, K series. Molded insulators, snaplock, aluminum. K9, small, in-line 9-element, manufactured in 2 models, K9-1



and K9-2 (illustrated). High level gain through vhf band. K3 Metropolitan series made in K3-1 and K3-2.—Kay-Townes Antenna Co., Rome, Ga.

ROOF MOUNT. Installed by one man in seconds. Snaps into place when upright. Locks with



tightening of hinge bolt.—Rohn Mfg. Co., 116 Limestone, Bellevue, Peoria, Ill.

INTERCOM KIT Knight-Kit, No. 83 Y 295. Two-way system—Master and remote stations plus 50-foot connecting cable. Only











1st

COMPLETE LINE of ELECTRONIC TOOLS

ever offered the industry

jobbers . . .

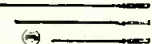
Our Reps will be happy to show you the complete line

 Smitty — 5 sizes	 Tension Tweezie	 Magic Tips — 15 sizes
 Tube Pullers	 Alignment Tool	 Tri-Tap "3-in-1"
 Reg. Screwdrivers	 Kits	 Nut-Drivers—15 sizes
 Slug Retrievers	 Tool Kits	 Hex Drivers—10 sizes



HUNTER TOOLS

Box 564
Whittier, California

ALL TOOLS IN SIZES TO FIT YOUR SPECIFIC NEEDS! TOOLS DESIGNED FOR THE ELECTRONIC INDUSTRY.

buy
and
use

CHRISTMAS SEALS

on every
package,
letter, and
Christmas
card

fight
tuberculosis

BUILD COMPUTERS AT HOME

Now can learn to build and maintain computers, design circuits program and gain a clear understanding of this vital force in our civilization. Our courses are geared to your requirements, and your previous knowledge of electronics and mathematics. Our specialty is computers and we provide the best instruction in computer theory and operation. You may look over the course materials at your convenience at home and if you decide to return them for any reason within the first week you may do so for credit or refund.

Course C4—Small Electric Brain Machines

This course comes complete with a kit of parts for building over forty computing, reasoning, game playing, adding and subtracting machines, including tic-tac-toe and music composition. Seven manuals and books of instructions. Machines require no soldering; over four hundred components and parts . . . \$28.00 post paid (add 80c. West of Miss.; \$2.00 outside U.S.).

Course C2—Digital Computers

Shows how to set up and build computers and experiment with pulses, storage, gates, flip-flops, adding, subtracting and multiply plus applications of Boolean Algebra to circuit design. Basic principles of programming. You learn how and where to buy parts for building your own computers. Provides a complete introduction to theory and practise of digital computers. Finest course in digital computer construction on the market. . . . C2 . . . \$60.00

Course C3—Analog Computers

Widely used in engineering and scientific research to duplicate actual physical conditions and to integrate and differentiate directly. Our Analog Computer course lists sources of material parts theory and practical instructions plus wiring diagrams and schematics for adding, subtracting, integrating and differentiate specific problems. You get practise in calculating scale factors, choice of time scales, machine equations. We show you how to build an analog computer at home. Tests discuss theory, practise and design. Your best comprehensive introduction to Analog Computers. Complete with all texts, instruction materials and schematics. . . . C3 . . . \$60.00. So enroll now for these exciting courses in computer operation. You may return the course materials for full refund for any reason within the first week.

Oliver Garfield Company
Dept. RE126
31 Broadway, New Haven, Conn.

Please enroll me in the courses I have encircled. I understand that all materials may be returned for refund within one week after purchase.

Course C2 C4 C3

I have enclosed in check or money order.

My name and address and previous background are attached.

JERROLD Introduces

TRAP-EASE*

Revolutionary New TV Filter Knocks Out Adjacent Channel Interference... Opens New Sales Market For The Television Trade!



Only \$19.95 List

This tunable "deep notch" antenna trap (greater than 50 db) permits TV viewers to remove "beat" or "herringbone" patterns caused by strong adjacent channel sound or video carriers. Permits clear reception of even weak distant stations.

Works with any TV receiver and any 300 ohm antenna that would normally bring in pictures from the distant stations if the interfering adjacent channel was not on the air. Does not affect reception of regularly viewed channels.

BRINGS IN PICTURES FROM OUT OF NOWHERE! **TRAP-EASE EASILY INSTALLED ON ANY TV SET!**

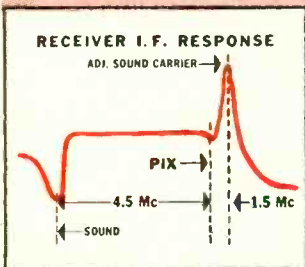
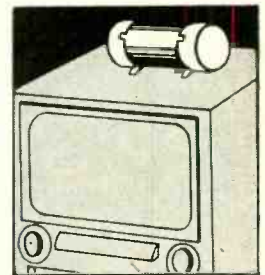
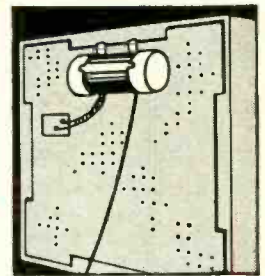
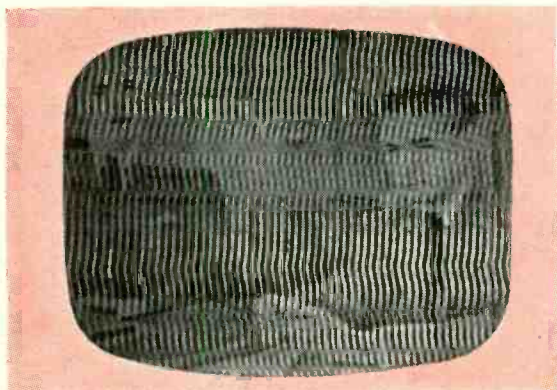

In case shown Receiver AGC is held down by a strong adjacent channel sound carrier. This lowers receiver gain and prevents proper reception of the desired channel. "Beat" or "Herringbone" pattern is predominant on the screen.

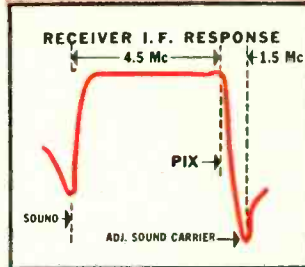

The adjacent sound carrier has been suppressed by some 50 db, which: (1) Enables the signal level of the desired channel to control the AGC action of the receiver. (2) Completely removes the "beat", leaving a clear, strong picture.

TRAP-EASE SELLS ITSELF

Let the amazing performance of the Jerrold Trap-Ease do its own selling. One demonstration and the Trap-Ease sells itself with the greatest of ease. Simple to demonstrate either in your store—or in the customer's home.

MONEY BACK GUARANTEE

Never before a TV accessory that achieves such startling results. Contact your Jerrold distributor today for details on the complete sales promotion package available to you.

TWO MODELS AVAILABLE

Low Trap-Ease (Model HQ-91) covers Channels 2 to 6.
High Trap-Ease (Model HQ-92) covers Channels 7 to 13.

JERROLD ELECTRONICS CORPORATION

2220 Chestnut Street • Philadelphia 3, Penna.

*©Jerrold Electronics Deep Notch Adjacent Channel Trap

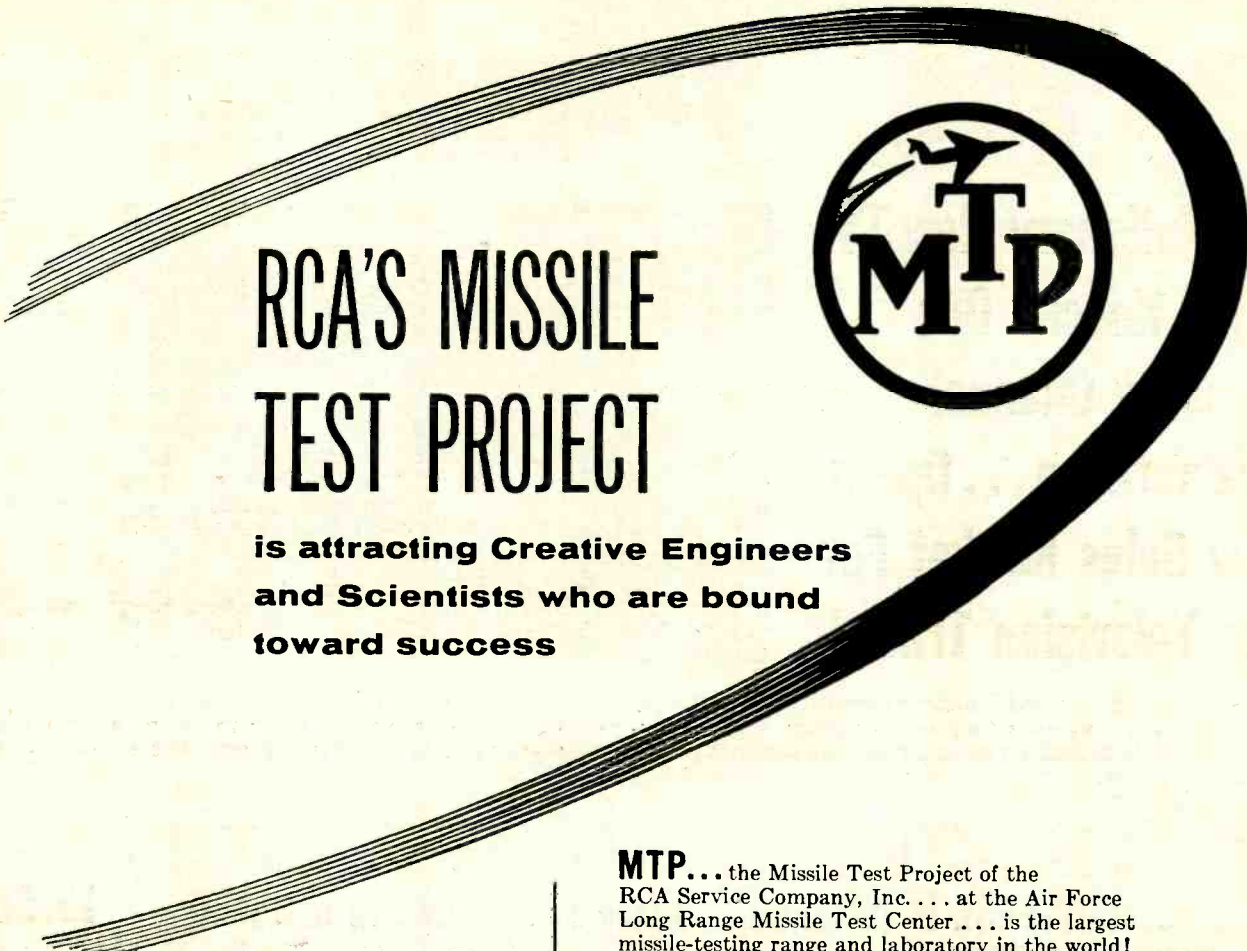

RCA'S MISSILE TEST PROJECT

is attracting Creative Engineers and Scientists who are bound toward success



Specific fields include:

- TELEMETRY**
- RADAR**
- TIMING**
- COMMUNICATIONS**
- DATA PROCESSING**
- OPTICS**

● **Request Your Interview NOW...**
RCA Engineering management will arrange an interview at the time and place you find most convenient. Please send complete resume of education and experience to:

**Mr. H. N. Ashby, Technical Employment
Missile Test Project, Dept. N-15M
RCA Service Company, Inc., P.O. Box 1226
Melbourne, Florida**

MTP... the Missile Test Project of the RCA Service Company, Inc. . . . at the Air Force Long Range Missile Test Center . . . is the largest missile-testing range and laboratory in the world! The responsibility for providing precision instrumentation for advanced stage missiles with a vast range of performance characteristics means new engineering and planning organizations and—real opportunity for rapid individual growth.

Here you will encounter instrumentation problems that challenge the state of the art and stimulate your creative ability in Aero, Ballistic and Space techniques.

Your rewards will include all the fascination, excitement and satisfaction of achievement in new frontiers of scientific knowledge . . . plus top salary.

What's more, you'll enjoy the pleasant climate and ideal living on Florida's central east coast, where Patrick Air Force Base, site of the MTP, is located.

RCA offers many additional advantages: Complete facilities . . . Planned advancement program . . . Professional recognition . . . Liberal program of company-paid benefits . . . Relocation assistance. You should have a Bachelor's or advanced degree in EE, ME, Physics or Mathematics and two or more years' experience.



Tmks. ®

RADIO CORPORATION of AMERICA

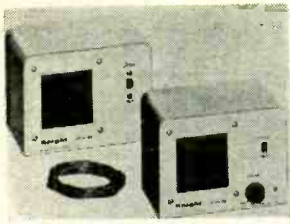

acoustical separator between the two. Fenton Co., 15 Moore St., N. Y. 4, N. Y.

PHONOMOTOR. For portable or small phonographs. 3 speeds. Metal or plastic 8-inch turntable. Rubber tire with upper and lower edges vulcanized to each other fixed to outer rim of idler wheel for balanced friction drive. Shock-mounted.—

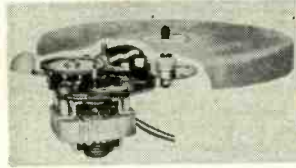

Power Equipment Dept., Federal Telephone & Radio Co., 35 Central Ave., E. Newark, N. J.

SPEAKER ENCLOSURE KITS. Finished in either Korina (blonde mahogany) or mahogany. Model PFK-610 modified corner horn for 12-inch speaker. Model PFK-630 modified corner horn for 15-inch speaker. Model

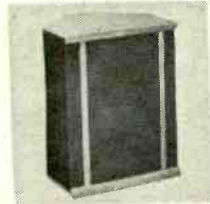

PFK-120 version of Klipsch Rebel KR4-12 corner horn. Accommodates a 12-inch speaker, tweeter and mid-range horn.

master connected to power source. Remote station has press-to-talk switch that can be left in talk position for continuous listening-in by master. Complete with all tubes, cable, solder, wire, all parts and instructions.—Allied Radio Corp., 100 N. Western Ave., Chicago 80, Ill.

MICROPHONE AND RIG. B&O 53 Microphone with ball swivel and finger-operated 3-position voice, music and off switch in cast-iron body. Multitapped output transformer has output impedances of 50, 250 and 40,000

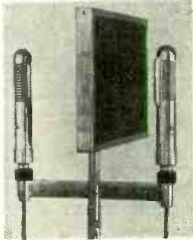

ohms. 20-foot cable, female microphone connector, snap-on bayonet adapter to 3/8x27-inch stand. *Binar Rig* for use with two B&O 53 or 50 microphones obtains same results as wide microphone placement with

Model PFK-150 duplicates Klipsch Rebel KR4-15 corner horn and holds 15-inch woofer, tweeter and mid-range horn. Model PFK-300 resembles Klipsch Rebel KR-3. Model PFK-500 for any 8- or 12-inch speaker.—G & H Wood Prods. Co., Inc., 99 No. 11th St., Brooklyn, N. Y.

IN-LINE MAGNETIC HEAD. Model TLD. For new equipment design, replacement and stereophonic conversion of existing



tape recorders. Can be compensated for flat response between 30 and 10,000 cycles at 7.5 ips.—Nortronic Co., 1015 S. 6th St., Minneapolis 4, Minn.

SELECTORS. Hi-3 Speaker Selector Model No. DS77 with 3-position switch. Used with any audio output for switching to



as many as 3 speakers at remote points when making temporary or permanent speaker coupling and comparison checks. 3-way Antenna Selector model DA88

with rotary 3-position selector switch. Where more than one to three individual antennas are to be coupled to one receiver. Up to three lead-in wires can be connected to selector (either 300 or 75 ohms) and 1 set of leads from selector to TV, FM, short-wave or multiband receiver.—Dynamic Electronics, 73-39 Woodhaven Blvd., Forest Hills, N. Y.

STEREOPHONIC SOUND SYSTEMS. Two-channel amplifier, model 3-DTG (illustrated) for

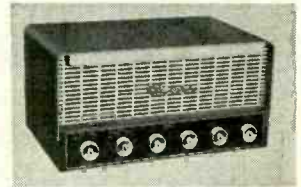

complete preamplification and power amplification for stereo signals from any source. Dual outputs, 10 watts each channel. One chassis. Tape recorder, BT-76, with stereophonic playback provided by a second head and preamplifiers. Staggered stereo heads feed separate equalizing preamplifier with these signals channeled from No. 1 head into recorder's self-contained power amplifier and speaker; from No. 2 head (by furnished cable) to any radio, TV or other amplifier with phone input. Console cabinet, BT-76, contains high-fidelity amplifier and pull-out speaker enclosure for optional remote use.—Bell Sound Systems, Inc., Columbus, Ohio.

Get This Valuable Book

FREE



Just For Examining COYNE'S New Set

"Applied Practical Radio-Television"

ON 7 DAY FREE TRIAL!

Yes, you get this big, brand new book, "150 Radio-Television Picture Patterns and Diagrams Explained", absolutely FREE! Just off the press. Gives complete 11 x 22" Schematic Diagrams on leading models Radio and TV Sets. Easy-to-read, large 8 1/2 x 11" pages, with full instructions on how to use the diagrams. A "must" in every repair kit. You get this book as a FREE Gift for asking to see Coyne's new 7-book set, "Applied Practical Radio-Television"!

At Last! Money-Making "Know-How" on Transistors, Color TV and Servicing

Coyne's great 7-volume set gives you all the answers to servicing problems—quickly! For basic "know-how" that's easy to understand you'll find everything you want in Volumes 1 to 5 on over 5000 practical facts and data. Every step from fundamentals to installing, servicing and trouble-shooting all types of radio and TV sets. So up-to-date it covers COLOR TV, UHF and the latest on TRANSISTORS. All this plus Volume 6—NEW Coyne TECHNICAL DICTIONARY with over 4000 definitions of the latest terms, symbols and abbreviations in radio-TV, electronics and electricity.

EXTRA! 900-Page Television Cyclopeda Included

And then, for speedy on-the-job use, you get volume 7—the famous Coyne TELEVISION CYCLOPEDIA. It answers today's television problems on servicing, alignment, installation, etc. In easy-to-find ABC order, cross-indexed. Use this 7-volume TV-RADIO LIBRARY FREE for 7 days; get the Servicing Book ABSOLUTELY FREE!

NOW!
7 BIG BOOKS
IN ONE GREAT SET!



SEND NO MONEY! Just mail coupon for 7-volume set on 7 days free trial. We'll include book of 150 TV-Radio Patterns and Diagrams. If you keep the set, pay \$2 in 7 days and \$2 per month until \$24.50 plus postage is paid. (Cash price, only \$22.95). Or you can return the library at our expense in 7 days and owe nothing. YOU BE THE JUDGE. Either way, the book of TV-Radio Patterns is yours FREE to keep! Offer is limited. Act NOW!

FREE BOOK—FREE TRIAL COUPON!

Educational Book Publishing Division
COYNE ELECTRICAL SCHOOL, Dept. C6-T1
500 S. Paulina St., Chicago 12, Ill.

YES! Send 7-Volume "Applied Practical Radio-Television" for 7 days FREE TRIAL per your offer. Include TV-Radio Patterns & Diagram Book FREE.

Name..... Age.....
Address.....
City..... Zone..... State.....
Where Employed.....
 Check here if you want library sent C.O.D. You pay postman \$22.95 plus C.O.D. postage on delivery. 7-day money-back guarantee.

Educational Book Publishing Division
COYNE ELECTRICAL SCHOOL
500 S. Paulina St., Dept. C6-T1, Chicago 12, Ill.

Almo... PRESENTS BRITAIN'S FINEST

BSR Monarch

AUTOMATIC RECORD CHANGER WITH HI-FI FLIP OVER CARTRIDGES

The ultimate in record changers... intermixes 7-10-12" records. Finest dual sapphire stylus gives faithful response to 10,500 cps. Shuts off after last record. Now only

\$22⁹⁵

4 Speed Turntable

NOW AT Almo RADIO CO.
913 ARCH ST., PHILA. • WA 2-5918

BRANCHES: CAMDEN, N.J. • ATLANTIC CITY, N.J. • TRENTON, N.J. • NORRISTOWN, PA. • WILMINGTON, DEL. • SALISBURY, MD.

Buy and Use Xmas Seals fight TB!

NEW DEVICES

(Continued)

TUNERS AND AMPLIFIERS. Hi-fi line of 8 tuners and 8 amplifiers. 4 tuners basic; 2 have

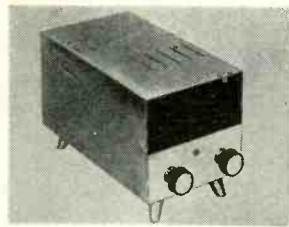

preamplifiers, 2 have preamps and amplifiers. 8 amplifiers range in power from 10 to 70 watts. Variety of transcription and record players and model ST10 stereophonic tape playback unit (see photo) designed for high-fidelity systems.—David Bogen Co., 29 9th Ave., N. Y. 14, N. Y.

sizes and shapes.—Hexacon Electric Co., 186 W. Clay Ave., Roselle Park, N. J.

MICROPHONE CHEST SUPPORT, Model NS-1 "Chesty". 3-way adjustment. Can be placed

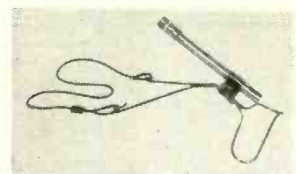

on speaker's chest, in his hand or any flat surface. 6 ounces.—Atlas Sound Corp., 1451 39th St., Brooklyn 18, N. Y.

PLIERS, No. 62 for flush cutoff in miniature and subminiature circuits. Small coil return spring

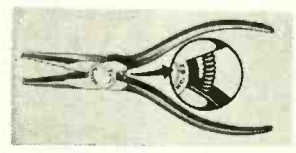

set into the body of the plier near leverage axis. For use in extremely small spaces. Cutting can be done by thumb and finger only.—Xcelite, Inc., Orchard Park, N. Y.

SOLDERING TIPS. Heavy coating of iron alloy over copper

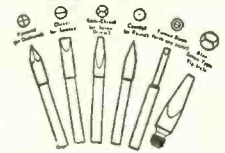

base on exposed surfaces for wear. Thin coating on inserted part for heat transference. 40

All specifications given on these pages are from manufacturers' data.

"We perform miracles with your microvolts"

BRAND NEW! TV AMPLIFIER

WITH 4 SEPARATELY CONTROLLED INPUTS

EQUIVALENT TO AT LEAST FOUR 38DB STRIP AMPLIFIERS

IDEAL FOR HOTELS, MOTELS AND APARTMENT HOUSES

PRICE **\$115⁰⁰**
Suggested User Net

- Separate 38DB Hi and Low band amplifiers.
- 4 volts maximum output: 2V. Hi-band, 2V. Lo-band.
- 4 separate inputs: any 2 Hi-band, any 2 Lo-band.
- 0-20DB variable attenuator in each input.
- Complete line of matched accessories available.
- Useful in areas with from 1 to 8 channels.

Write for complete information and technical specifications

BENCO TELEVISION ASSOCIATES LTD.
278 BRIDGELAND AVENUE, TORONTO 10, CANADA

STATEMENT OF THE OWNERSHIP, MANAGEMENT, AND CIRCULATION REQUIRED BY THE ACT OF CONGRESS OF AUGUST 24, 1912, AS AMENDED BY THE ACTS OF MARCH 3, 1933, AND JULY 2, 1946 (Title 39, United States Code, Section 233) of RADIO-ELECTRONICS published monthly at Mt. Morris, Illinois, for October 1, 1956.

1. The names and addresses of the publisher, editor, managing editor, and business managers are: Publisher, Gernsback Publications, Inc., 154 W. 14 St., New York 11, N. Y.; Editor, Hugo Gernsback, 154 W. 14 St., New York 11, N. Y.; Managing Editor, Fred Shunaman, 154 W. 14 St., New York 11, N. Y. Business Manager, none.

2. The owner is: Gernsback Publications, Inc., 154 W 14 St., New York 11, N. Y.; H. Gernsback, 154 W. 14 St., New York 11, N. Y.; M. Harvey Gernsback, 154 W. 14 St., New York 11, N. Y.

3. The known bondholders, mortgagees, and other security holders owning or holding 1 percent or more of total amount of bonds, mortgages, or other securities are: None.

4. Paragraphs 2 and 3 include, in cases where the stockholder or security holder appears upon the books of the company as trustee or in any other fiduciary relation, the name of the person or corporation for whom such trustee is acting; the affiant's full knowledge and belief as to the circumstances and conditions under which stockholders and security holders who do not appear upon the books of the company as trustees, hold stock and securities in a capacity other than that of a bona fide owner.

H. GERNSBACK, Publisher
Sworn to and subscribed before me this 16th day of September, 1956.
[Seal] Irving Abramson,
Notary Public
(My commission expires March 30, 1957)

why the Collaro

RC-456

is today's outstanding HIGH FIDELITY RECORD CHANGER



**Minimum
Noise and
Distortion**

Balanced, heavy 4-pole motor . . .
balanced pulley and coupler reduce
rumble to an inaudible minimum.
Automatic muting switch and R/C
network eliminate 'clicks.'

**Accurate
Speed & Pitch**

Collaro quality control limits for the
RC-456 are .25% wow and flutter
. . . unmatched by any other
record changer.

Jam-Proof

Collaro safety-clutch prevents
damage even if tone-arm is held
or moved during change cycle.

Four Speeds

Plays all 78, 45 and 33 $\frac{1}{3}$ rpm
records . . . plus new types designed
for 16 $\frac{2}{3}$ rpm speed.

**Automatic
Intermix**

Plays 7, 10 and 12-inch records
stacked in any order —
automatically.

**Manual
Operation**

For playing records individually or
for selecting and playing specific
bands and parts of a record.

**Simple
Installation**

Prewired power and audio connections
eliminate soldering. Pre-cut
mounting board available.

...Plus

- ★ Rapid change cycle independent of record speed.
- ★ Automatic 'shut-off' after last record.
- ★ Simple, one-knob speed selection.
- ★ Gentle, straight-spindle record handling.
- ★ Interchangeable, plug-in cartridge shells.
- ★ Heavy, rim-weighted turntable for flywheel action.
- ★ Automatic idler-disengage prevents idler flats.

At leading sound dealers, or write Dept. WM-16

ROCKBAR CORPORATION • 650 Halstead Avenue, Mamaroneck, N. Y.



UNTIL DEC. 31st ONLY ... LEKTRON'S ANNUAL DOUBLE BONUS

WITH EVERY ORDER OF \$10 OR MORE!

BONUS #1
Your choice of ANY \$1 KIT FREE!



BONUS #2
\$10 Assortment of Radio Parts (Approx. wt. 5 lbs.) FREE!

ELEVEN DOLLARS WORTH OF PARTS = FREE

With Every \$10 Order!



As a "thank you" to our thousands of customers the world over ... **FREE XMAS GIFT WITH ANY SIZE ORDER!**

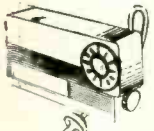

SCOOP! PERSONALIZED SUPERHET PORTABLE
COMPLETELY WIRED, READY TO PLAY!
\$12.99
LOWEST PRICE ANYWHERE!

☐ Sold elsewhere from \$20 to \$27! Completely wired, ready to go! Plays anywhere, with no external connections. Handsome ivory styrene case (only 5 1/2" x 3 1/2" x 1 1/4") slips easily into pocket. Truly PERSONALIZED w/hearing-aid phone. CONELRAD freqs. marked for emergencies, Civil Defense. Covers broadcast band—530 to 1550 KCS. Ruggedly built by top craftsmen. 3 miniature tubes, sensitivity & selectivity equal to big-set performance. Must be heard to be believed! ☐ BATTERIES Gift packed, ship. wt. 1 lb. ☐ \$2 EXTRA

Subminiature SPEAKER

☐ Top make, ruggedly built. Only 1 1/2" sq.; weighs only 3 oz. 3.2 ohms V.C. 2 oz. magnet. Projectors, notes! In orig. cartons. **only \$1.99**

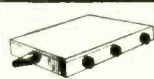

by "KIT KING"

NEW! EXCLUSIVE! TRANSISTOR RADIO KITS

- ☐ KIT #1. "SOLAR/CELL". Dual-powered, pocket size! Sensitive, ample volume. Sun Battery for daytime or electric light. Mercury Cell for nights—lasts regular batteries 5 times! MINUTES TO COMPLETE—ALL PARTS MOUNTED! Pre-drilled styrene cabinet, step-by-step instructions, hi-gain transistor, diode, latest loopstick permeability tuner, posts, jacks, wire, hardware. Wt. 3 oz. **\$5.88**
- ☐ KIT #2. "SOLAR". Sun Battery powered. (Kit #1 less mercury cell). only **\$4.98**
- ☐ KIT #3. "CELL". Mercury Cell powered. (Kit #1 less Sun Battery). only **\$3.98**
- ☐ HI-IMPEDANCE PHONES for above sets... only \$1.99
- ☐ SOLDERING IRON with solder included... only \$4

LEKTRON'S FAMOUS DOLLAR BUYS! EXCLUSIVE WITH LEKTRON!

- ☐ 60 XFMRs & COILS. IF, RF, ant. slug-tuned coils, chokes. 25 types! **\$1**
- ☐ 3 200-MIL CHOKES. 2H, 60 ohms. Open frame, strap mtd. Wt. 2 lbs. Reg. \$6. **\$1**
- ☐ 15 ROTARY SWITCHES. Wide ass't. ceramic & bakelite units; incl. multiple gangs. Wt. 3 lbs. Reg. \$14. **\$1**
- ☐ 40 MOLDED CONDENSERS. .0001 to 0.1mf up to 1000V. Brown, black ceramic cased. Wt. 1 lb. Reg. \$8. **\$1**
- ☐ 4 CRYSTAL DIODES. 2 subminiatures. 1N34, 1N68. Reg. \$5. **\$1**
- ☐ 8-PC MOTORDRIVER KIT. Plastic handle, 3/16, 7/32, 1/2, 5/16, 11/32, 3/8, 7/16" steel socket wrenches in plastic case. Wt. 1 lb. \$3 val. **\$1**
- ☐ 4 SILICON DIODES. 1N21, 1N22, 1N23. **\$1**
- ☐ 20 HI-QUALITY KNOBS. Knurled, skinned, engraved. Brass insert w/set screws. Wt. 1/2 lb. \$1 Reg. \$7. **\$1**
- ☐ 10 ELECTROLYTICS. FP & twist tubular, rect. Ass'd. sizes, 8 to 500mf to 450 V. Wt. 3 lbs. Reg. \$15. **\$1**
- ☐ 2000 pcs. HARDWARE. screws, springs, washers, etc. Reg. \$8. **\$1**
- ☐ 70 RESISTORS. Insulated IRC, A-B, etc. 5 ohms to 10 meg; 1/2, 1, 2W; 1% & 5%. Wt. 2 1/2 lb. Reg. \$10.95. **\$1**
- ☐ G-E PREAMP KIT for magnetic cartridges. Chassis, parts, diagram; lens 6SC7 (88c extra). Wt. 1 lb. Reg. \$4.50. **\$1**
- ☐ 15 ERIE TRIMMERS. 8-50 mmf. Reg. \$1 **\$1**
- ☐ 30 TUBE SOCKETS. 4, 5, 6, 7, 8, 9, 11-prong. Miniatures, octals, wafers, "zip-ins," tube shields, too. Wt. 2 lbs. **\$1**
- ☐ 40 POPULAR BULBS. 1.1 to 6V, screw & bayonet types, miniature. Wt. 1/2 lb. Reg. \$3. **\$1**
- ☐ 70 STANDARD KNOBS. Ass'd. colors; bakelite & plastic. Wt. 2 lbs. **\$1**
- ☐ 75 CERAMIC CONDENSERS. 35 ass'd. values; tubular & discs. 5mmf to .01mf up to 3 KV. Wt. 1/2 lb. Reg. \$11. **\$1**
- ☐ SIGMA SENSITIVE SPDT. Enclosed case. Wt. 1/2 lb. Reg. \$7.50. **\$1**
- ☐ 50 PLUGS & RECEPTACLES. Wide variety for AC, power, test, incl. fuse posts, too. Wt. 3 lbs. **\$1**
- ☐ 30 VARIABLES, mica & air types. Excellent assortment includes shift types, too. Wt. 1 lb. **\$1**
- ☐ R/C SCOOP! Chassis includes: 6L XFM, 115VAC to 6.3 @ 1.5A; 3000 ohm relay, resistors, condensers, sockets. Wt. 2 lbs. Reg. \$8. **\$1**
- ☐ 150 COIL FORMS. Ass'd. herm. sealed types, miniature bakelite & compressed forms. 20 styles. Wt. 2 lbs. Reg. \$9. **\$1**
- ☐ 40 OIL CONDENSERS. Bathub, tubular, rect. types. .005 to 1 mf up to 600V. Wt. 3 lbs. Reg. \$13. **\$1**
- ☐ DIODE RADIO KIT. Complete w/pre-drilled cabinet, germ diode, loopstick, instructions. All parts mounted. Wt. 1/2 lb. Reg. \$3. **\$1**
- ☐ 15-PC TWIST DRILL SET. 1/16 thru 1/4" by 64th. In graduated plastic holders. Reg. \$4. **\$1**
- ☐ PHOTO TIMER. 0 to 60 minutes. Panel type w/bell alarm. Wt. 2 lbs. Reg. \$3. **\$1**
- ☐ SUN BATTERY & photo electric cell, for photoelec. relays, etc. Reg. \$1 \$5. 1 1/2" dia. **\$1**
- ☐ 10 "POLY" BOXES. Ass'd. sizes, clear plastic hinged boxes w/snap locks. Reg. \$2.50. **\$1**
- ☐ 70 TERMINAL STRIPS. 20 screw & solder pts. Wt. 1 lb. Reg. \$5. **\$1**
- ☐ 15 VOLUME CONTROLS. Ass'd. values to 1 meg. Duals w/switch, too. Wt. 1 lb. Reg. \$1 \$9. **\$1**
- ☐ 125 RESISTORS. Insulated & uninsulated. 30 values, 52 types; 1 to 1/2 to 2W, 5%, 100. Wt. 1 lb. Reg. \$10. **\$1**
- ☐ 60 TUBULAR CONDENSERS. 30 types, .0005 to 0.5 mf to 1500V. **\$1**
- ☐ WW condohm, sand-coated, vitreous. 15 values; 5 to 50W, .35 to 11000 ohms. Wt. 2 lbs. Reg. \$1 \$8. **\$1**
- ☐ PIC-A-TUBE SALE! Circle 6AG5 ... 6B6 ... 6V6. Any two for \$1. **\$1**
- ☐ 40 SUBMINIATURE RESISTORS. Exclusive! 11 ohms to 10 meg; 1/5 w; 20 values. Color-coded. **\$1**
- ☐ 2 TRANSISTOR LOOP-STRICKS. Tapped for better selectivity. Quick tuning without knobs. Transistors for projectors, motel. **\$1**
- ☐ 40 MINATURE CAPACITORS. Subminiature, printed circuit types, too. Ass'd. values to 1 mf. **\$1**
- ☐ 8 TRANSISTOR SOCKETS. In poly. box. Builders' must! Reg. \$1 \$2.50. **\$1**
- ☐ 3 TRANSISTORS. Scoop! CBS-Hytron experimental plug-in type, for printed circuits. Worth \$3 each! **\$1**
- ☐ 10 PANEL SWITCHES. 15 & 25 micro, push, power types. W/OFF-ON switchplates. Wt. 2 lbs. **\$1**
- ☐ 3 OUTPUT XFMRs. (Circle any 3). 50B5, 35L6, 50L6, 6V6; to 3-4 ohms. Reg. \$150. **\$1**
- ☐ 30 PRECISION RESISTORS. WW & carbofilm. 30 values, 56 ohms to 1 meg; 1/2, 1 & 2W; 1% tol. Wt. 1/2 lb. Reg. \$21. **\$1**
- ☐ 175-FT. HOOKUP WIRE. In 25-ft. rolls. Ass'd. colors, stranding, insulation. 2 to 24. Wt. 2 lbs. Reg. \$3.75. **\$1**
- ☐ 20 AC/DC LINE CORDS for clocks, motors, etc. Molded plugs, 2 cond. Wt. 1 lb. Reg. \$5. **\$1**
- ☐ 7 CERAMIC CONDENSERS. 30 values; .0001 to 1000V. Silver, 5% included. Wt. 1 lb. Reg. \$5. **\$1**

HOW TO ORDER
Check items wanted. Return entire ad with check or MO. Include sufficient postage; excess returned. C.O.D. orders, 25% down. Rated, net 30 days. Print name, address, amount money enclosed, in margin. RE-12

LEKTRON SPECIALTIES
Visit our salesroom, 131 Everett Ave., Chelsea 28 Gardener Street Chelsea 50, Mass.

OVER 97,000 TECHNICIANS HAVE LEARNED HOW TO GET THE MOST OUT OF BASIC TEST EQUIPMENT for AM FM-TV

'Servicing by Signal Substitution'
A BEST SELLER FOR OVER 13 YEARS!
(NEW, UP-TO-DATE, 14th EDITION)

The Modern, Simplified, Dynamic Approach to all Receiver Adjustment & Alignment Problems

- ★ Nothing complicated to learn
- ★ No extra equipment to purchase
- ★ Universal... non-obsolete
- ★ Employs only Basic Test Instruments

Ask for "S.S.S." at your local Radio Parts jobber or remit 40¢ in small stamps or coin directly to factory.

ONLY 40¢
103 pages. Invaluable information that will help you redouble the value of your basic test equipment.

PRECISION APPARATUS COMPANY, INC.
70-31 84th STREET, GLENDALE 27, L. I., N. Y.

new Tubes Transistors

1N536, 1N539, 1N540

Expansion of its line of 165°C low-current silicon rectifiers has been announced by G-E. The new types (see photo) are the 1N536, 1N539 and 1N540 for use in aircraft and other airborne computers, guided missiles, magnetic amplifiers and electronic and electrical equipment operating at high temperatures.

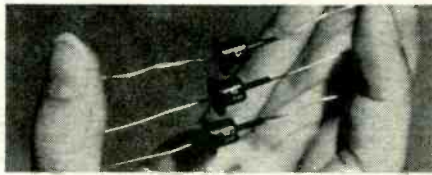

The 1N536, 1N539 and 1N540 are rated, respectively, at maximum peak inverse voltages of 50, 300 and 400. Maximum allowable rms voltages are 35, 210 and 280, respectively. These rectifiers supplement the previously announced 1N537 and 1N538 (New Tubes, September, 1956).

Maximum rated output current for the series is 750 ma at an ambient temperature of 50°C and of 250 ma at 150°C. The full-load forward voltage drop is a maximum of 0.5 volt at 150°C. All in this series have axial leads.

2N247, 2N267

Drift transistors of the germanium p-n-p type, the 2N247 and 2N267 are intended primarily for use as rf amplifiers in military and commercial equipment and in entertainment type receivers covering the AM broadcast band and up into the shortwave bands. They are also useful as if amplifiers or as mixer-oscillators (converters).

These RCA-announced transistors have a base region in which the impurity distribution is very carefully controlled to produce a built-in accelerating field, not available in conventional transistor designs, which propels the charge carriers from emitter to collector. Base resistance and collector-to-base capacitance are substantially reduced. The low values of these parameters permit the design of rf amplifier circuits having high input-circuit efficiency, excellent operating stability, good age capabilities over a wide range of input signal levels and good signal-to-noise ratio.

The 2N247 has four flexible leads and is hermetically sealed in an insulated metal case having a length of 0.375 inch and a maximum diameter of 0.360 inch. Shielding minimizes interlead capacitance between collector and base leads and also coupling to adjacent

circuit components. This feature contributes to the usefulness of the 2N247 in high-frequency circuits particularly in military and commercial applications where very low feedback capacitance is an important consideration. The shielding is provided by a fourth lead situated between the collector and base leads and internally connected to the insulated metal envelope.

The 2N247 features a collector dissipation of 35 mw maximum. In a common-emitter circuit with base input this transistor can provide a power gain as high as 45 db at 1.5 mc and 24 db at 10.7 mc. The very low collector transition capacitance (1.7 μmf) makes possible satisfactory gains in the AM broadcast band without a neutralizing network.

The 2N267 has the same electrical characteristics as the 2N247 except that it has a slightly larger feedback capacitance in the common-emitter type of circuit. The 2N267 has three flexible leads and is constructed with a smaller metal case having a length of 0.405 inch and a maximum diameter of 0.240 inch. It is intended for compact transistor designs where a high-frequency transistor having small size is a primary consideration.

Fuse type rectifier

Sarkes Tarzian has announced a new fuse type silicon rectifier to replace all selenium rectifiers in radio, TV and other electronic devices. The new unit, the M-500, has a peak inverse voltage rating of 400, with maximum dc current at 500 ma. With an input voltage of 130, at maximum current, the approximate rectifier voltage drop is 2.

This unit was designed primarily for use in television receivers where voltage-doubler circuits operate directly off the line. The M-500 is $\frac{1}{4}$ inch in diameter and approximately 1 inch long; it fits into a standard fuse holder.

6883

A small, sturdy, beam power tube, the 6883 may be used as an rf power amplifier and oscillator as well as an af power amplifier and modulator in mobile equipment operating from a 12-volt storage battery. Except for its heater rating of 12.6 volts at 0.625 ampere, the 6883 is identical with the 6146 which has a 6.3-volt 1.25 ampere heater.

The 6883 has a maximum plate-dissipation rating of 25 watts under ICAS conditions in modulator and CW service. For CW the 6883 can be operated under ICAS conditions with 90 watts input up to 60 mc and with 60 watts input at 175 mc.

Because of its high power sensitivity and high efficiency, the 6883 requires relatively low plate voltage to give large power output with small driving power.

16,000-volt silicon diodes

A series of high-voltage silicon diodes (see photo) announced by International

NEEDED:

Key men to command the nerve center of America's Defense

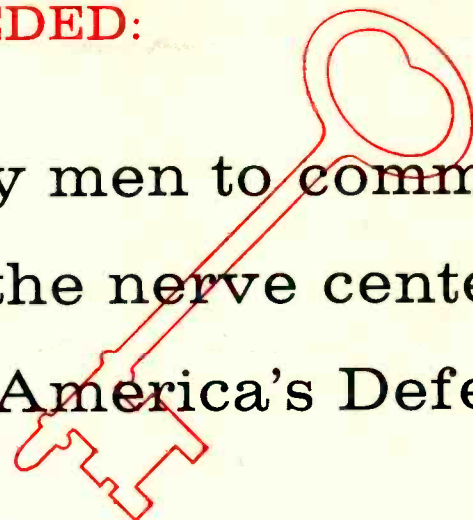

Today, at IBM, engineers are playing new and vastly more important roles. In cooperation with the Air Force, IBM engineers and technicians are guarding America's lifeline with Project Sage, our continent's air defense warning system.

The world's largest computer—"nerve center" of Project Sage—was designed and manufactured through the ingenuity of IBM engineers. This electronic masterpiece embodies the most advanced concepts in the field of digital computers . . . so large it is housed in a building 4 stories tall and half a city block square . . . so powerful it is equipped with 50,000 vacuum tubes. Just to understand the incredible mathematical calculations of this machine is an education in itself. Imagine the knowledge and prestige that you could gain by actual work experience with IBM for Project Sage!

SYSTEMS ENGINEERS are necessary for the performance, evaluation, reliability testing and over-all maintenance of the computer's operation. Here is a challenge that demands the very best you've got. An E.E., M.E., or Physics degree is required.

FIELD TECHNICIANS are equally important for effective control—working on physical maintenance and component analysis. In time, these specialists have the opportunity to assume full engineering responsibility at IBM. Two-year technical schooling in electronics or equivalent is required.

TRAINING—estimated at \$10,000 per man—will take place at the IBM plant in Kingston, N. Y. Systems Engineers will receive approximately nine months' and Field Technicians

approximately six months' instruction. These training programs will emphasize computer circuits and units and maintenance techniques.

RAPID PROMOTIONS await the conscientious, ambitious man at IBM. Advancement is based solely on merit. You'll work in small teams, where talent and ideas are quickly recognized and rewarded.

EXCELLENT SALARIES prevail; a living allowance over and above the training salary; more than just the customary employee benefits; ideal working conditions; and facilities that rank second to none.

STABILITY is guaranteed by a 43-year record of solid growth through diversified service to industry, government and education.

IBM built the first of these mighty, large-scale computers at Kingston, N. Y. Identical computers are now under construction at Portland, Me., Syracuse, N. Y., Richmond, Va. IBM will do its utmost to assign you to the location which you prefer. Of course, all moving expenses will be paid for by IBM.

Here is a real ground-floor opportunity that you can't afford to overlook. Your potential is virtually unlimited in this dynamic, new field of digital computers. Get all the facts. WRITE, outlining the details of your background and interests, to: R. W. Hubner, Director of Recruitment, Dept. 3112, International Business Machines Corp., 590 Madison Avenue, New York 22, N. Y.

CUSTOMER ENGINEERS: opportunities are also available, locally, for servicing IBM machines, after training with pay. Contact your nearest IBM office.

DATA PROCESSING
ELECTRIC TYPEWRITERS
TIME EQUIPMENT
MILITARY PRODUCTS

IBM

**MILITARY
PRODUCTS**



Time for REPLACEMENT?

Specify
OXFORD
SPEAKERS

Speakers is our prime business and we supply more of the BEST manufacturers of original equipment. Since we have quality replacement speakers for any and every application . . . you will actually better the original sound with OXFORD SPEAKERS.

Why wait . . . find out TODAY why more and more servicemen are switching to OXFORD SPEAKERS . . . when it's time for replacement!

Our latest catalog is available . . . write today!

...at better jobbers!

OXFORD Components, Inc.

Subsidiary of OXFORD ELECTRIC CORP.

556 West Monroe Street, Chicago 6, Ill.

In Canada: Atlas Radio Corp., Ltd., Toronto

Export: Roburn Agencies, New York City

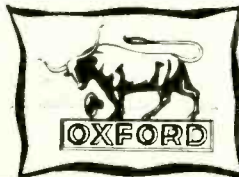

TAPE RECORDERS

Tapes—Accessories
Nationally Advertised Brands

UNUSUAL VALUES

Send for Free Catalog

DRESSNER

69-02 RE: 174 St.
Flushing 65, N.Y.

MERITAPE

Low Cost. High
Quality Record-
ing Tape—in
boxes or cans.

CABINETS HI-FI—TELEVISION CUSTOM-BUILT and STOCK

write for descriptive literature

JACK CANTOR

171A Washington St.—New York 7, N. Y.

For All Your HI-FI REQUIREMENTS

Write us first

Complete stock of Quality Components
Special Low Prices on Discontinued Equipment

**Our Consultation Service
Is at Your Disposal**

Suggested Systems from \$150 and up

SOUND MART UNLIMITED, INC.

Dept. E 119 East 59 Street
New York 22, New York

FREE! COMICAD CARD KIT

FREE CATALOG TODAY!—shows our complete line of TV Service Reports, Call Books, Phone Message Books, Job Tickets, Service Pricing Guide, File Systems, Service Contracts, Parts Warranties, P. O. Forms, Statement Books, Label Books, Sketch Pads, Cash Books, etc. See them at your parts jobber. **WRITE NOW!**

Oelrich Publications 4308 Milwaukee Ave.
Chicago 41, Illinois

NEW TUBES AND TRANSISTORS (Continued)

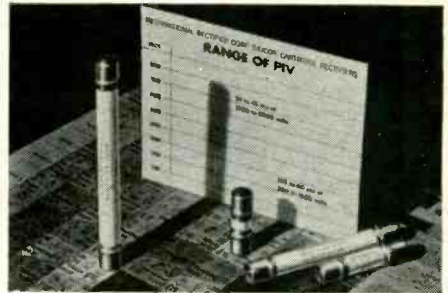

Rectifier Corp., includes units having peak inverse voltage ratings of 600 to 16,000 with forward currents of 100 and 45 ma, respectively. These diodes offer high rectification efficiency over an operating ambient temperature range of -55°C to 150°C and are applicable in all types of high-voltage low-current supplies.

2N206

A new junction transistor of the germanium p-n-p alloy type, the 2N206 has been announced by RCA. It is designed primarily for use in audio-frequency amplifier applications. The transistor is hermetically sealed, using a metal envelope with external insulating coating. It has flexible leads. The 2N206 is 0.240 inch in diameter and has a length of 0.405 inch.

Maximum ratings as a class-A amplifier are: collector-to-base voltage, -30 ; emitter-to-base voltage, -12 ; collector current, -50 ma; emitter current, 50 ma; collector dissipation (for 25°C ambient temperature), 75 mw.

In a common-emitter circuit with base input, the 2N206 has a current transfer ratio of 47, a low-frequency power gain of 46 db (with a load resistance of 20,000 ohms and an input resistance of 1,200 ohms) and a noise factor of 9 db. In such a circuit the dc collector-to-emitter voltage would be -5 , the dc collector current -1 ma. END

Thirty-Five Years Ago

In Gernsback Publications

HUGO GERNSBACK, Founder

Modern Electric	1908
Wireless Association of America	1908
Electrical Experimenter	1913
Radio News	1919
Science & Invention	1920
Television	1927
Radio-Craft	1929
Short-Wave Craft	1930
Television News	1931

Some larger libraries still have copies of ELECTRICAL EXPERIMENTER on file for interested readers.

In December, 1922, Science and Invention (formerly Electrical Experimenter)

Transmitting Power by Radio.
Pilotless Mail Planes, by H: Winfield Secor.

Horse Racing by Radio.
Broadcasting Niagara's Roar.
The Simplest Radio Outfit Contest
(Seventh Prize), by George Goga (Pencil Radio).

Home-Made Radio Movies.
Radio Tuning Devices and Circuits, by A. P. Peck.

Radio for the Beginner, No. 10, by Armstrong Perry.
Radio Oracle.

GUIDE

AUTRONIC-EYE[®]

TRAINING COURSES
MEAN MORE
BUSINESS FOR YOU!



Courses for experienced service technicians provide latest repair information—enable you to do the job faster and more efficiently.

Quick, accurate circuit diagnosis and repair to factory specifications boosts your profits. That's why so many qualified auto technicians attend these Guide training courses at no cost other than transportation and living expenses.

The Guide Lamp diploma, awarded only to those who successfully complete the course, is proof that you're equipped to give more and better service to more people—and that means business.

If you're an auto radio service dealer, come yourself, or send your technicians. There's one of 30 GM Training Centers near you. Apply through your local United Motors Service Division Distributor or write

GUIDE LAMP DIVISION • GENERAL MOTORS CORP. • ANDERSON, INDIANA

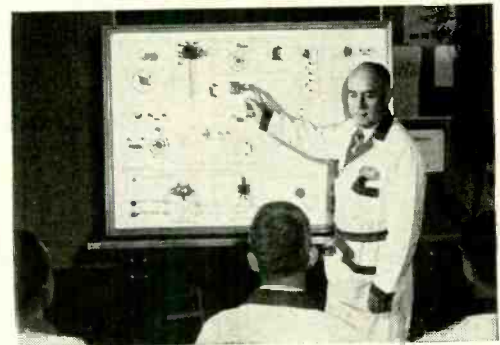

Jumbo-size operational panel of Guide's Autronic-Eye Circuit puts all parts out front for better, more efficient instruction.



Thirty modern GM Training Centers offer newest equipment and latest service techniques. There's one nearby . . . no matter where you live.

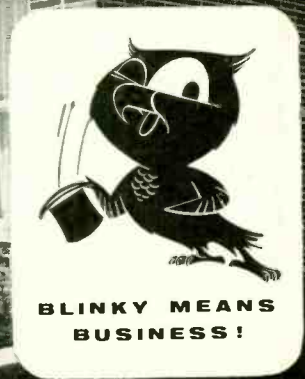

Technicians' News



COLOR AT FAIR

Color TV and captive service will keynote the lecture portion of the program at the Electronics Fair to be held at Farmingdale, Long Island (N. Y.) Dec. 6, 7 and 8. Talks on color antennas, test equipment components and both the standard three-gun and the Chromatic one-gun tubes and the complete associated color receivers will be featured prominently. Veteran service publisher Paul Wendell will discuss under the title "Fight for Survival!" the legal and economic repercussions of manufacturers getting into the service business.

Arrangements have been made, with the cooperation of RCA and Jerrold Electronics, to have an antenna distribution system for off-the-air color programs and a closed-circuit setup for times when no color programs are on the air so that exhibiting color TV

manufacturers will be able to demonstrate their equipment at all times.

The Fair is being held at the New York State University, Farmingdale, N. Y. RADIO-ELECTRONICS is among the exhibitors, at booth 42.

CAPTIVE SERVICE OPPOSED

The decision of a number of large TV manufacturers to extend their factory service is meeting with sharp opposition at all points. Meetings have been held and plans made in Chicago, Detroit, Cincinnati; St. Louis, Mo.; Bridgeport, Conn., and other points to combat the new threat to the independent service technician. Cincinnati service technicians announced their meeting with a poster printed entirely in red, adopting the slogan "You Must Act Now—Tomorrow May Be Too Late." The Detroit meeting initiated a "Unite to

unbelievable!
BUT TRUE!
sensational
**PICTURE TUBE
TEST & REPAIR
INSTRUMENT**
AT A STAGGERINGLY LOW PRICE
• The lowest price picture tube test and repair instrument available.
• No other equipment needed to do the job.

ONLY \$7.95 COMPLETE

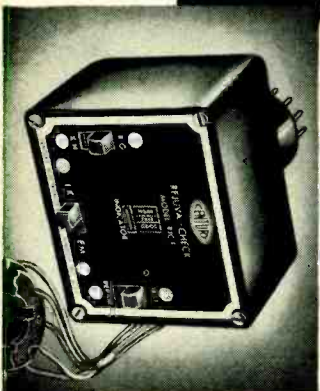

the **MIGHTY** portable
REJUVA-CHECK

TESTS: Checks cathode emission, indicates shorts and leakage between elements
• Estimates remaining life of the CRT
REPAIRS: Clears inter-plate shorts and leakage
• Removes cathode surface contamination
REJUVENATES: Gives new life to tubes by restoring emission

RIGHT ON THE JOB!
FITS SNUGLY IN YOUR TUBE CADDY
ready to earn extra dollars for you . . .

FREE ACT NOW! Receive valuable imported pin straightener and tube puller.

RADIO-TV ROUNDUP

Professional Radio-TV Technicians Invite Public to Use Professional Tube Testers Without Charge

A short cut to the short circuits, and to the other illnesses which sometimes plague radios and TV sets, is now open to those of the Greater Houston area.

Professional radio and television technicians renewed this week their invitation to one and all to test their radio and TV tubes on professional equipment under the supervision of a professional technician, and all without charge.

It was pointed out that only those people in the full-time business of radio and television set repairing can af-

ford the elaborate, expensive testing equipment necessary to give completely reliable readings throughout the wide range of tubes to be tested.

Inferior machines may give false readings, indicating the need for a new tube when the tested tube is perfectly adequate for several months of additional service.

Important, too, is the fact that most repair shops sell only highest-quality tubes. Brand-name manufacturers, such as Westinghouse, very carefully check all out-going tubes. When newly manufactured tubes are found to

be faulty in some way, they are junked by most nationally known manufacturers. Some, however, may be sold to companies who re-label them and sell them through outlets other than repair shops. These inferior tubes, which may be retailed at identically the same prices as full-quality tubes, may cause quite a bit of customer disappointment.

Colorful window banners identify participating repair shops. The banner reads "Radio and TV Tubes Tested Free. Under the Supervision of a Professional Technician."

Listed below are some of the participating firms:

A & L TELEVISION SERVICE
6709 Chocolate Bayou Rd.

BRAWDY RADIO & TV SERVICE
5910 Washington

OLSEN RADIO & ENGINEERING CO.
1843 W. Alabama

ALEXANDER'S RADIO & TV SERVICE
7006 N. Main St

COTTON TELEVISION & RADIO SERVICE
3143 Alabama St.

S O S RADIO SERVICE
1641 Westheimer Rd.

BRATTENG'S TV & RADIO CENTER
6904 Stella Link Rd.

HOUSE OF TELEVISION
1972 West Gray

CLAYTON SALES
Highlands, Texas

MELROSE TELEVISION SERVICE & SALES
1324 Berry Rd.

LAKE TELEVISION SERVICE
Lake Jackson, Texas

ADVERTISEMENT

SEND NO MONEY
ACT NOW! Pays for itself on one or two calls.
POSITIVELY NO OBLIGATION!

CENTURY ELECTRONICS CO., INC.
111 Roosevelt Ave., Dept. RE-12, Mineola, N. Y.
OK, rush my FREE GIFT and REJUVA-CHECK for a FREE 10 day service trial on my toughest service calls. At the end of 10 days I will send \$7.95 plus postal charge or return instrument. In any case the gift is mine to keep.

Name.....
Address.....
City..... State.....

Some POSTAL CHARGES! Enclose \$7.95 with order and we pay all postal charges. Some NO-RISK refund privilege.

TV technicians of Houston, Tex., have devised a competent answer to self-service tube testers. The advertisement above is self-explanatory.

Fight" program in which Detroit, Grand Rapids, Pontiac, Mt. Clemens, Tecumseh, Flint, Birmingham and Kalamazoo trade groups are participating. Technical and business clinics are also being held, to insure that the independent service technician will be at least as capable of handling repair of all types of electronic equipment as any repairmen likely to be hired by the manufacturers' service branches. These are being supported by all service groups, including among others the Television Service Association of Michigan (TSA), NATESA, NARDA and also the AEC American Electronic Council).

The Bridgeport meeting, which lasted from morning till 10 pm, agreed that servicing associations must stop "bickering." It adopted a 10-point program aimed at helping to stabilize independent operation and to combat manufacturers' interference in the independent service industry.

New England, New York, New Jersey and Pennsylvania were represented at the meeting, with Dave Krantz of Philadelphia acting as coordinator for the Pennsylvania federation, John Wheaton heading the New York State federation, David Van Nest making plans for the New Jersey group and Albert C. W. Saunders of Boston handling the Massachusetts representation.

NEW DIAGRAM SERVICE

A move to assist the smaller service organization which does not subscribe to a continuing diagram service has been announced by John F. Rider. Covering the products of the eight largest TV manufacturers over the past five years, a *single diagram service* called S-D-O (single diagram only) will permit technicians to obtain the data on a given chassis for the economical price of 50 cents. Schematic, voltage data, tube layouts, alignment information, trimmer locations, adjustments, etc., are supplied on a 17 x 22-inch sheet, which can be folded for convenient filing. Models covered in the first group of sheets, states Mr. Rider, encompass between 80% and 90% of the receivers sold during the past five years.

ARTS ELECTS

The Associated Radio & Television Servicemen, (Chicago) Illinois, elected their 1956-57 officers at the semi-annual business meeting held in September.

Howard Wolfson was elected chairman, Joe Ehlinger vice chairman, Delmar Kotrba secretary-treasurer, George Neize sergeant-at-arms. Member representatives for the south, west and north sections of Chicago were also appointed for the ensuing year. They are Martin Nebojsic, Anthony Bauman and Yuki Minaga. END

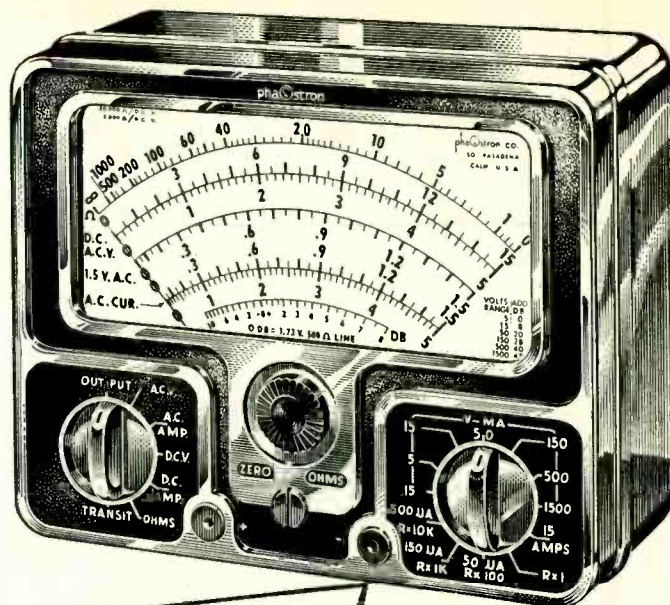

PHAOSTRON

555A VOM

YOU NEED THESE FEATURES:

Meter Movement Protection up to 500 times overload is provided by a rectifier network.

The 555A Measures: AC Current, DC Current, AC Voltage, DC Voltage, Output, Resistance

43 Unduplicated Ranges

Separate Range and Function Switches

Double Magnetic Shielding

3% DC, 4% AC Permanent Accuracy

Easy to Read, Four Color Scales 4 7/8" long

Metal Case with Die Cast Bezel 6 1/8" x 4 5/8" x 2 1/8"

Sensitivity: 20,000 Ohms/Volt DC, 2000 Ohms/Volt AC

Complete with Probes and Batteries at your Parts Distributor **\$44.50**

PHAOSTRON INSTRUMENT AND ELECTRONIC COMPANY

151 Pasadena Avenue, South Pasadena, California

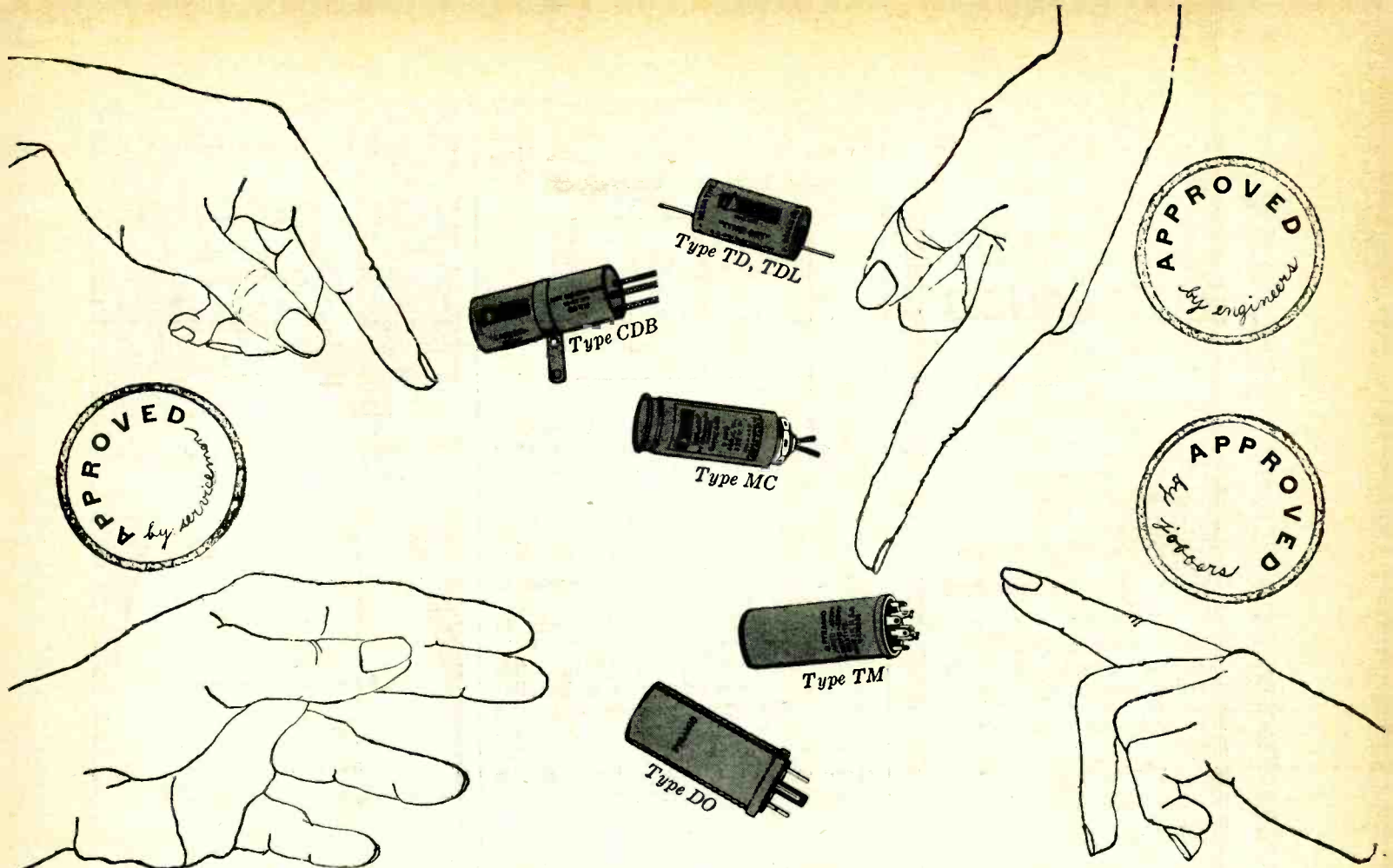

**YOU CAN'T ARGUE
WITH ACCEPTANCE**

The most complete line of twist mount
dry electrolytic capacitors
Proven quality, 100% inspected, accurate
replacement, prompt delivery

Better than any claims we could make is the unqualified and enthusiastic acceptance by engineers and servicemen alike. These are some of the features on which this acceptance is based:

- Aluminum containers provide maximum protection against moisture.
- Low leakage, long shelf life.
- Designed for 85° C. operation.
- Complete with metal and bakelite mounting plates.
- Easy to mount.
- Extremely compact—yet highly dependable. Pyramid capacitors are listed in Sams' Photofacts and Counterfacts.

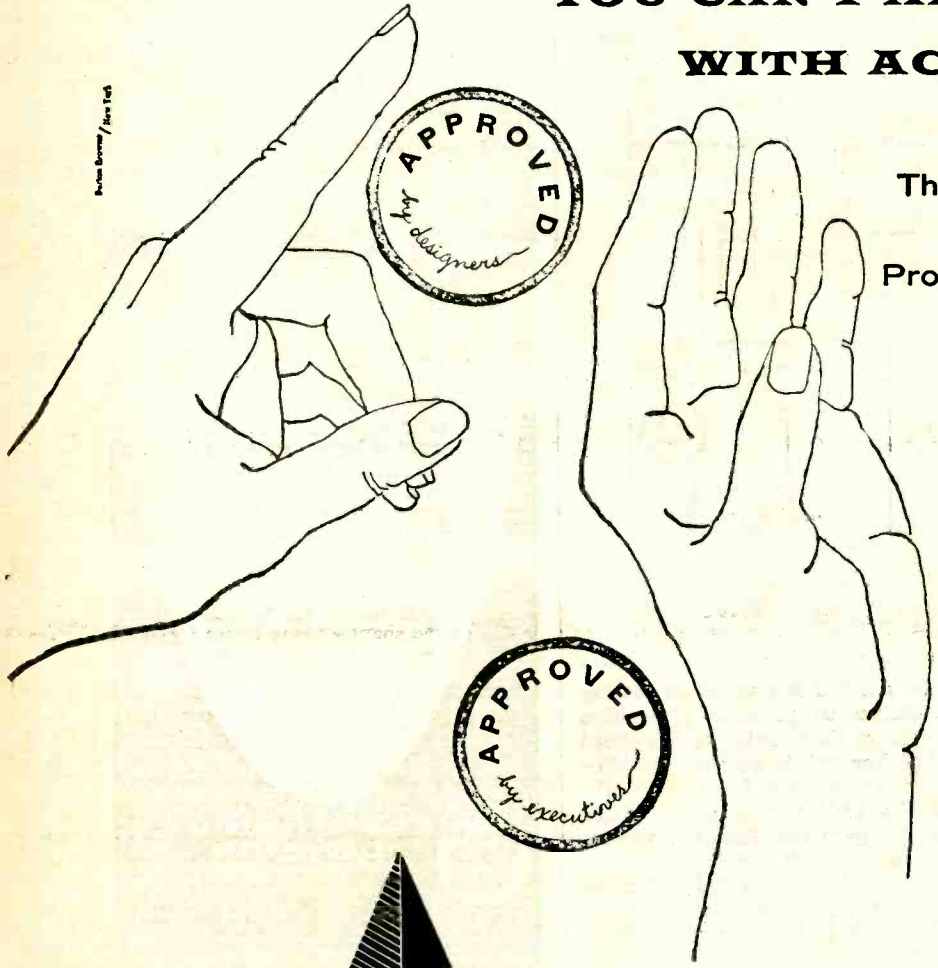

PYRAMID ELECTRIC COMPANY
1445 Hudson Blvd., North Bergen, N. J.

HANDBOOK OF BASIC CIRCUITS

By
Matthew Mandl

At last—a quick, convenient reference to all types of communications circuits

including

- SWEEP SYSTEMS • SYNC SYSTEMS
- AUDIO & RF AMPLIFIERS • POWER SUPPLY
- OSCILLATORS • DETECTORS
- TRANSISTORS • DISCRIMINATORS

136 important circuits

each illustrated by schematic drawing and explained as to characteristics and purpose. Math and formulas at a minimum.

An absolute necessity for
Graduate Engineers Students
Technicians Amateurs

Price \$7.50

MANDL'S TELEVISION SERVICING

Rev. Ed.

By Matthew Mandl—\$6.50

NOW YOU CAN USE THE METHODS OF THE EXPERTS

Simple, clear explanations of the fundamentals of monochrome and color TV. Complete servicing instructions for UHF and VHF. Servicing details for the latest types of equipment: transistor, gated beam detector, color TV circuits and 100 more.

You'll learn the time-saving methods used by the experts without unnecessary theory or involved math. Illustrated every step of the way.

guarantee your future
SEND NOW!

STUDY ONE OR BOTH FREE
FOR 10 DAYS WITHOUT
OBLIGATION

CLIP AND MAIL TODAY

The Macmillan Company, Dept. RE-5
60 Fifth Avenue, New York 11, N. Y.

Please send me:

- HANDBOOK OF BASIC CIRCUITS \$7.50
- MANDL'S TELEVISION SERVICING \$6.50

I will either remit the full price or return the book(s) in 10 days.

Check or money order enclosed saving me delivery charge.

Name.....

Address.....

City..... Zone..... State.....

Distributors in Canada: Brett-Macmillan Ltd.
26 Hollinger Road, Toronto 16.

RADIO-ELECTRONIC CIRCUITS (Continued)

The values of R and C are selected to give the desired flashing rate. Normal variations in the lamps, resistors

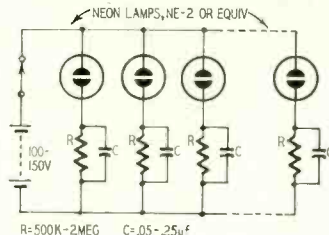

and capacitors will give each lamp a slightly different flashing rate even when the same values are used.

THUNDERBIRD'S SPEED CONTROLS RADIO VOLUME

One of the latest developments in automobile radios is the speed-compensated volume control used in compensated volume control used in Motorola's model 79MS (Ford FEJ-18806-C) receiver for custom installations in the 1957 Thunderbird. The circuit automatically varies the receiver's volume in proportion to the speed of the car. The pertinent circuit is shown in the diagram.

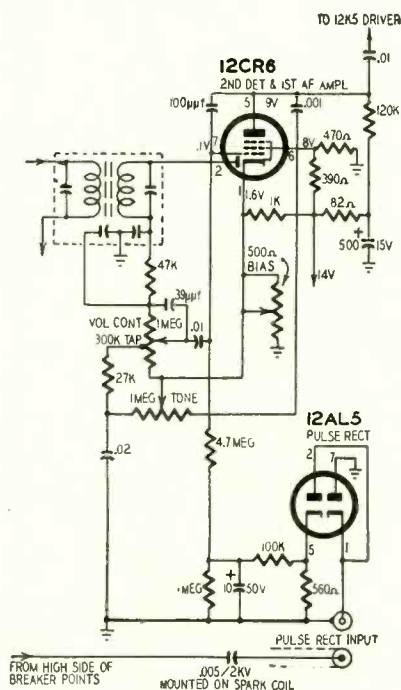

A voltage is tapped off the breaker points and applied to a voltage-doubling pulse rectifier to produce a positive output voltage that varies as the speed of the breaker points or the car. This dc voltage is filtered and applied to the grid of the 12CR6 first af amplifier to cause the gain and thus the volume to vary with the car's speed.

Minimum volume is set by manual control and the speed-compensated circuit takes over to increase the volume as the car speeds up and drop it gradually to the preset level as the car slows below a certain speed.

CERAMIC CARTRIDGES



LOADED with PROFIT

- Lightweight, miniature size, greater compliance
- New mechanical construction gives higher output
- New "throw-away" element
- Simple replacement, snap-in action
- Assorted stock orders totaled for maximum discount
- "Clearamic"—The "new look in good listening"

New Turnover Type



Response . . . 40-12,000 cycles
Output . . . 1-1.2 volts

New Single Needle Type



Response . . . 40-12,000 cycles
Output . . . 1-1.2 volts

Turnover type features "throw-away" element offering snap-in replacement of both element and needle assembly for essentially the price of a good replacement needle. Single needle type features simplified self-locating needle replacement.

Ask for the handy new "dispenser" assortment — meets almost all replacement needs.



ELECTRONICS DIVISION

ELGIN NATIONAL WATCH COMPANY

For Cartridges:

2435 N. NAOMI STREET,
BURBANK, CALIFORNIA

Sales representatives in principal cities.

Question Box



VERTICAL ANTENNA

I have a 50-foot vertical antenna for broadcast reception. It is mounted about 150 feet from the house to get away from the noise field of nearby power and telephone lines. My problem is the design of an efficient low-noise coupling system for feeding the receiver. What kind of transmission line should I use and how do I match it to the antenna and receiver?—E. S., Wausau, Wis.

A 50-foot vertical antenna is only about 1/24 wavelength long at the high-frequency end of the broadcast band. It will have a very low radiation resistance (around 1 ohm or less) and a very high capacitive reactance. This reactance limits the current flow in the antenna and must be eliminated by adding an equivalent inductive reactance in series as shown. The inductance (loading coil) must be variable and its range determined experimentally. TV linearity and width coils are available in a wide range of inductances and you should be able to find one to do the job. The inductance ranges provided by the inductors shown may be satisfactory or you may have to use units with higher or lower ranges.

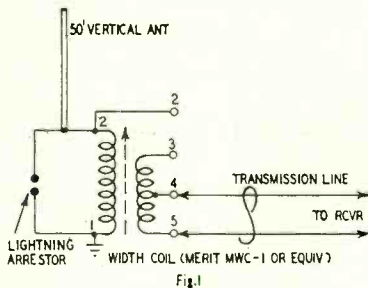
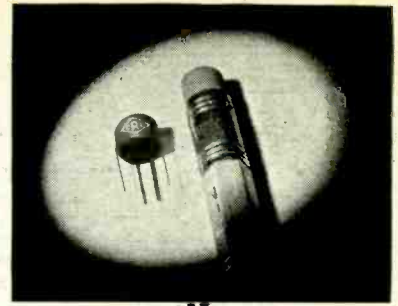

Fig. 1

In the circuit in Fig. 1, the main winding of a width coil is used as the loading coil and the age winding as a link coupling to the transmission line. The unit specified has several windings and taps that make it possible to try many different connections. Start with the connections shown and then try connecting the transmission line across various combinations of terminals 2 through 5. Readjust the slug tuning after each change.

Fig. 2 is a slightly different arrangement with the antenna base-loaded and the reactance of the lead-in tuned out by the variable capacitor. The loading coil is tuned by the slug. Try various connections and slug settings until you find the best combination. You can connect the base of the antenna to the tap on the coil—leaving the top end



Model TA-6

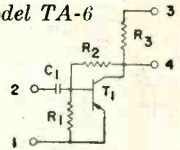

A PRIZE TROPHY

for miniaturized audio amplification

No closed season... no limit... to its applications

New Centralab Single-Stage Transistor Amplifier

- ◊ High-gain, low-power transistor amplifier can be used by itself in microphones and other miniature circuit designs. Or, you can combine several units, to get a multiple-stage unit for other audio applications.
- ◊ This is a complete amplifier housing capacitance, resistance, transistor, and wiring. Gain, 24 db. Noise level, less than 1/2 millivolts. Supply voltage, 1.35 v.
- ◊ As small as an eraser on an ordinary lead pencil.
- ◊ Ask your Centralab distributor for Model TA-6— or TA-7. Send coupon for Bulletin EP-75 containing complete information, schematics, and curves.

Centralab

A DIVISION OF GLOBE-UNION INC.

922L East Keefe Avenue, Milwaukee 1, Wisconsin

Y-5625

Send me free Bulletin EP-75.

Name _____
 Company _____
 Address _____
 City _____ Zone _____ State _____



IMPROVE your AMPLIFIER in 5 ways



with the

Amperex®

GZ34 RECTIFIER

A LOW-IMPEDANCE, INDIRECTLY HEATED, FULL-WAVE RECTIFIER WITH 250 MA OUTPUT CAPACITY

The unique AMPEREX GZ34 replaces without circuit changes, in the majority of amplifier circuits, an entire line of popular, heavy-duty 5-volt rectifiers—5U4G, 5V4G, 5T4, etc.

— with the following benefits:

- Better voltage regulation due to lowered power supply impedance;
- Higher power supply output voltage for more power;
- Added filter condenser protection due to reduced ripple;
- Cooler operation due to lower voltage drop;
- Protection of costly power output tubes through delayed warm-up.

OTHER Amperex TUBES FOR HIGH-FIDELITY AUDIO APPLICATIONS:

EL84/6BQ5	9-pin power pentode; 17 W PP
GCA7/EL34	High-power pentode; 100 W PP
EF86/6Z67	Low-noise high- μ pentode
ECC81/12AT7	Low-noise medium- μ dual triode
ECC82/12AU7	Low-noise low- μ dual triode
ECC83/12AX7	Low-noise high- μ dual triode
EZ80/6V4	9-pin rectifier; cathode; 90 ma.
EZ81/6CA4	9-pin rectifier; cathode; 150 ma.

At All Leading Electronic Parts Distributors

**Amperex
ELECTRONIC CORP.**
230 Duffy Ave., Hicksville, Long Island, N.Y.



QUESTION BOX

(Continued)

open—or ground the bottom end of the coil and connect capacitor to tap.

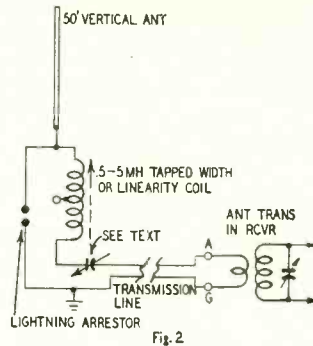

In both circuits, the loading and tuning network should be housed in a weatherproof box and a good ground and lightning arrester should be provided for safety and best operation. The lead-in may be any convenient coax.

AUDIO CABLE

Manufacturers of hi-fi equipment often recommend low-capacitance audio cable for connecting pickups, tuners and other accessories to the amplifier and specify that the cable length should not be excessive. What is considered a low-capacitance cable and what length is excessive?—E. M. B., New York, N. Y.

Generally, a low-capacitance audio cable has a capacitance of around 25 μf per foot and an outside diameter of 0.2 to 0.25 inch. Capacitance usually decreases as outside diameter increases. The very thin and flexible phonograph pickup type cable is not satisfactory for runs of more than a foot or so because of its high capacitance. Limit its use to the run from the cartridge to the nearest convenient terminal strip or tie point. Use low-capacitance cable for the rest of the run.

Cable such as Alpha 1704, Belden 8401, Birnbach 1841, Columbia 1318 and Cornish 2401 should fill the bill. RG-62/U and RG-71/U have a capacitance of only 13.5 μf per foot and are recommended in cases where the added cost and slightly greater diameter are not important.

The length that may be considered as being excessive depends on the characteristics of the equipment being connected. For example, if you have a low-impedance high-output source such as a tuner or some magnetic type pickups, a run of 50 feet or so might not be considered excessive. On the other hand, if you are working from a high-impedance low-output source, the high-frequency losses are likely to be heavy.

A length of 15 feet or so would not be considered excessive when low-capacitance cable is used between moderately high impedances in most installations.

TONE CONTROLS FOR SX-42

I want to add separate tone controls for bass and treble boost and cut to my SX-42 receiver. I will eliminate the

do you
know
what to
charge
your
customers?

for this



or this



or this



or this

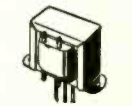

you can find out
in seconds
when you use

Dave Rice's

OFFICIAL PRICING DIGEST



When your customer questions the cost of replacement parts, you can quickly prove your prices are correct when you use the Official Pricing Digest... with list or resale prices on over 60,000 components. Arranged alphabetically by manufacturer and product, numerically by part number. Always up-to-date, issued every three months. Compact, convenient size fits in tube caddy, tool box or pocket. \$2.50 per copy.

FOR EVERY TV-RADIO SERVICE SITUATION

use Dave Rice's
OFFICIAL SERVICE
ORDER BOOK
(FORM TVR-100)

Has separate listings for six tubes, receiving tubes, parts serial numbers, labor and tax charges, signatures. 50 sets of triplicate orders in each book—carbons bound in. 75c per copy, \$6.50 for box of ten.



At your distributor or direct from
ELECTRONIC PUBLISHING COMPANY, INC.
180 NORTH WACKER DRIVE
CHICAGO 6, ILLINOIS

QUESTION BOX

(Continued)

original tone control and am willing to add a tone amplifier or another stage if needed. Please print a suitable circuit.

This receiver drifts badly for about 2 hours on FM when first turned on. Can you help me correct this?—
H. K. H., Pacific, Mo.

The diagram shows how bass and treble controls can be installed in your receiver. A single stage of amplification compensates for the loss in the tone control circuit. The circuit in the diagram is inserted between the arm of the volume control and the grid of the tube to which the control originally connected.

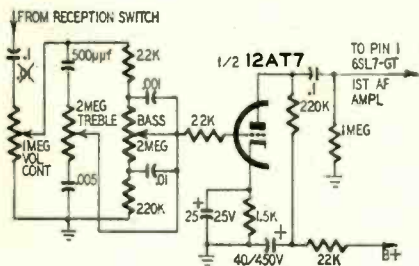

You can install this circuit in most conventional radios and amplifiers. Plate supply voltages may be in the range of 150 to 250. (If the set or amplifier is an ac-dc type, you may have to install a filament transformer for the added tube.)

Warmup drift that continues for several hours is usually due to poor design and selection of the capacitors, coil and other components in the oscillator circuit and we do not recommend trying to eliminate the faulty parts in a set such as the SX-42. Instead, we suggest adding afc. You'll find complete details in the articles "Adding AFC to Your FM Tuner" and "Reactance-Tube Tuning Vernier" in the November, 1954, and May, 1953, issues, respectively. The afc adapter in the November, 1954, issue uses a 6K4 reactance tube. You can substitute half of a 12AT7 for the 6K4 (see Question Box, February, 1955) and use the other half for the 12AT7 in the tone control circuit above. END



"You've got an open speaker field, Doc. What've I got?"

Model TA-11
Measures only
1/2" x 1" x 1/4"

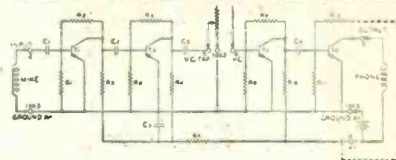
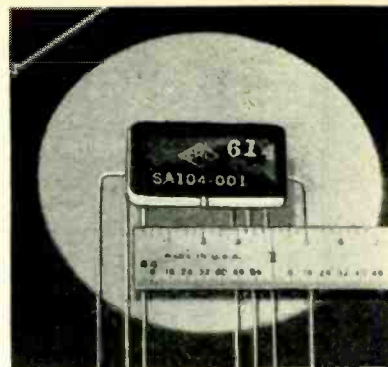

TALK ABOUT FUN!

It starts here, with this

New Centralab Four-Stage Transistor Amplifier

- ◊ You can use it in building all sorts of pocket-size radios and recorders, test equipment, computers, other projects where an ultraminiature, low-power, high-gain, dependable audio amplifier is desired.
- ◊ The most advanced form of Packaged Electronic Circuit. Includes four special transistors, in addition to five capacitors, 12 resistors, and wiring.
- ◊ Gain, 75 db. Supply voltage, 1.3v. Signal to noise ratio, 38 db. nominal.
- ◊ Ask your Centralab distributor for Model TA-11. Send coupon for Bulletin EP-75 containing complete information, schematics, and curves.

Centralab

A DIVISION OF GLOBE-UNION INC.
922L East Keefe Avenue, Milwaukee 1, Wisconsin Y-5624

Send me free Bulletin EP-75.

Name _____
Company _____
Address _____
City _____ Zone _____ State _____



*Trademark

THE Senco Line is "Mighty Fine"

Each Senco item is designed with the serviceman in mind. Created by highly qualified design and service engineers to **SAVE COSTLY SERVICE** time, Senco products **HAVE RAPIDLY GROWN** in acceptance—Now are leaders in low cost test instruments and accessories. **Attractive packaging, informative literature and unsurpassed quality, truly guarantee a "line that is mighty fine."**



SENCO FILAMENT CHECKER
Quickly finds any open filament. Especially handy for servicing series filament TV sets and radios; only checker that checks all octals, loctals, 7 and 9 pin minatures automatically. Also continuity and voltage tester.

Model FC4
Dealer Net
With Leads . . . \$2.95 Without Leads . \$2.75



NEW SENCO TRANSISTOR CHECKER
Now wanted and needed by every serviceman, approved by leading mfrs. Provides these 4 important checks on all transistors: Open—short—current gain—leakages. Checks forward to backward resistance of all diodes.

Dealer Net \$15.95 Model TDC22



UP-DOWN VOLTAGE BOOSTER
Model LB2

A practical line voltage regulator—half the price of others. Increases power line voltage ten volts, decreases it ten volts, or restores it to normal with the flick of a switch, rated up to 300 watts. Handles all black and white TV sets. Dealer Net \$5.97

Model LB2N
Same as Model LB2, but with neon lamp. Glows @ 126V indicating high line voltage.
Dealer Net \$7.17



TUBE and CAPACITOR LEAKAGE CHECKER

A highly accurate tester for detecting leakage between tube elements. "Two Testers in One"
A reliable instrument for indicating capacitor leakage with 50 volts applied. Quickly indicates
• Grid to cathode leakage • Grid emission • Heater to cathode leakage • Gassy tubes
Checks 70 Critical Tube Types
Complete with Leads and Wired . . . \$24.95
Kit form \$19.95
Leatherette Carrying Case \$2.00



ALIGN-O-PAK BIAS SUPPLY
for TV ALIGNMENT and AGC TROUBLE-SHOOTING

Model BE3
NOW—Provides any DC voltage from 0 to 18 volts DC positive or negative. Completely isolated power supply with less than 1/10 of 1% ripple.
Dealer Net . . . \$7.85



Model JC2
UNIVERSAL TV JUMPER CORD
Jumps power from TV back to chassis. No more plugging into wall sockets—moving of furniture—winding and unwinding cords. It's universal—fits any set. NO SHOCK HAZARD.
Dealer Net . . . \$1.95



Model PP2
PEAK to PEAK COMPARISON METER
A completely assembled Peak to Peak Meter at half the price of a kit. A must when servicing AGC, Sync Separators, Etc. Dealer Net . . . \$8.75

All products carry standard 90 day warranty. Available at leading distributors everywhere.
Senco Manufactured by **SERVICE INSTRUMENTS CO.**
171 Official Road • Addison, Ill.

Technotes

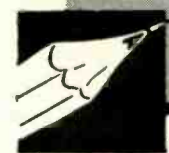

VERTICAL JITTER

In the Westinghouse chassis V2233 C1 (Fig. 1) lost considerable capacitance. The result was an intermittent vertical jitter at intervals. The customer said the jitter was accompanied by a dimming of the electric lights such as occurred when an electric toaster or some other appliance was turned on.

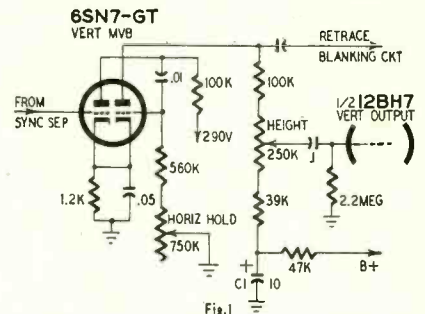

The jitter—almost a bounce with several rapid shakes up and down—was caused by a fluctuating line voltage with the corresponding fluctuations in the low-voltage power supply.

Inasmuch as only the vertical circuit was affected, the vertical supply was checked. Shunting the capacitors that filtered the B supply localized the trouble to C1.

Since the trouble occurred when the line voltage varied, the line voltage was jumped up and down by the arrangement shown in Fig. 2. The transformer

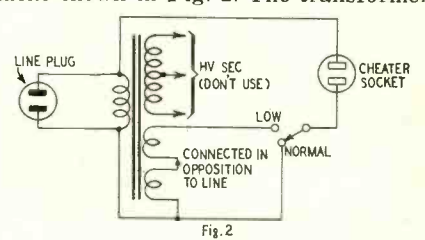

was from a junked TV dog. The secondaries are connected in series opposition to the primary so that the voltage may be dropped the 6.3 volts of the heater filaments and the 5 volts of the rectifier filaments simply by throwing the switch. Actually, the drop was about 2 volts more than 11.3 since the secondaries were lightly loaded. This device is very useful for cases of trouble caused by low high line voltage.—L. A. Williams

MOTOROLA 21T15

This Motorola had a rounding off of the left-hand corners of the raster. Linearity on the left side of the picture was very bad also. The vertical and horizontal sizes were below nor-

For Your Protection

RADIO-ELECTRONICS is continually alert to maintain a high level of integrity in our advertising columns. In the case of tube advertising—which has suffered special abuses—we insist that all advertisers must warrant that their tubes are:

- New and unused
- Not mechanical or electrical rejects
- Not washed or rebranded

(See page 57 of the January, 1956, issue)

We investigate carefully when we have grounds to suspect that any advertiser is not living strictly up to these rules.



The Equation that Shook the World!

A hasty scrawl on a scrap of paper ushered in the Atomic Age. Through this equation, Dr. Albert Einstein revealed to mankind the awesome secret of atomic fission, with all of its tremendous power for good or evil.

This is the kind of a world we live in . . . a world where knowledge is power in a truer sense than ever before. It is an exciting world.

Univac® has added a new dimension to the world of science, processing data with a speed that crowds many lifetimes of research into a few hours.

Squarely in the midst of this exciting world are the engineers and scientists of Remington Rand Univac. Their potential for growth and achievement (and the rewards that go with them) is unlimited. *You can be one of them.*

Immediate Openings for:

FIELD LOCATION ENGINEERS with a college degree in a scientific or engineering field and experience in electronics. Extensive electronic background may substitute for some college. Many opportunities for rapid advancement.

FIELD LOCATION TECHNICIANS with technical school background and preferably some experience in electronics. These positions can lead to full engineering responsibility.

Send complete resumé to:

Remington Rand Univac

DIVISION OF SPERRY RAND CORPORATION

Mr. Phil Wilson

Dept. FD-10

1902 W. MINNEHAHA AVENUE • ST. PAUL W4, MINNESOTA

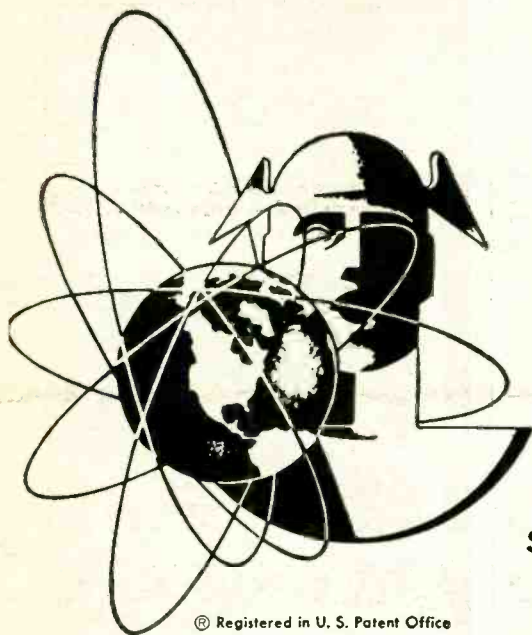

© Registered in U. S. Patent Office

BUILD 16 RADIO CIRCUITS AT HOME

with the New Improved 1957 Progressive Radio "Edu-Kit" only **\$19.95**

A PRACTICAL HOME RADIO COURSE

Now Includes
SOLDERING IRON, TESTER, HIGH FIDELITY, SIGNAL TRACER, CODE OSCILLATOR, PRINTED CIRCUITRY

FREE TOOLS

- No Knowledge of Radio Necessary
- No Additional Parts or Tools Needed
- Excellent Background for TV
- Unconditional Money-Back Guarantee



Reg. U. S. Pat. Off.

FREE Hi-Fi. Radio & TV Servicing Manuals on Request. (See Coupon Below).

WHAT THE "EDU-KIT" OFFERS YOU

The "Edu-Kit" offers you an outstanding PRACTICAL HOME RADIO COURSE at a rock-bottom price. You will learn radio theory, construction and servicing. You will learn how to build radios, using regular schematics; how to solder and wire in a professional manner; how to service and trouble-shoot radios. You will learn how to work with punched metal chassis as well as the new Printed Circuit chassis. You will learn the principles of RF and AF amplifiers and oscillators, detectors, rectifiers, test equipment. You will learn and practice code, using the Progressive Code Oscillator. You will build 16 Receiver, Transmitter, Code Oscillator, Signal Tracer and Signal Injector circuits, and learn how to operate them. You will receive an excellent background in Electronics and Radio, worth many times the small price you pay, only \$19.95 complete.

PROGRESSIVE TEACHING METHOD

The Progressive Radio "Edu-Kit" is the foremost educational radio kit in the world, and is universally accepted as the standard in the field of electronics training. The "Edu-Kit" uses the modern educational principle of "Learn by Doing." You begin by building a simple radio. Gradually, in a progressive manner, and at your own rate, you construct more advanced multi-tube radio circuits, learn more advanced theory and techniques, and do work like a professional radio technician.

THE KIT FOR EVERYONE

You do not need the slightest background in radio or science. The "Edu-Kit" is used by young and old, schools and clubs, by Armed Forces Personnel and Veterans Adm. for training and rehabilitation. The "Edu-Kit" is used in 79 countries throughout the world.

Designed for universal use, the "Edu-Kit" operates on any voltage from 105 to 125 volts, AC and DC. For use in countries employing higher line voltages, a 210-250 Volt AC/DC model is available.

THE "EDU-KIT" IS COMPLETE

You will receive all parts and instructions necessary to build 16 different radio and electronic circuits, each guaranteed to operate. Our kits contain tubes, tube sockets, variable capacitors, electrolytic and paper dielectric condensers, resistors, tie strips, coil hardware, tubing, punched metal chassis, instruction Manuals, etc. In addition, you receive Printed Circuit materials, including Printed Circuit Chassis, special tube sockets, hardware and instructions. You also receive a useful set of tools, a professional electric soldering iron, and a self-powered, dynamic Radio and Electronics Tester. The "Edu-Kit" also includes Code instructions and the Progressive Code Oscillator. You will also receive lessons for servicing with the Progressive Signal Tracer and the Progressive Signal Injector, a High Fidelity Guide, FCC Amateur License Training Book, and a Quiz Book. All parts, components, etc. of the "Edu-Kit" are 100% unconditionally guaranteed, brand new, carefully selected, tested and matched. Everything is yours to keep. The complete price of this practical home radio and electronics course is only \$19.95.

TROUBLE-SHOOTING LESSONS

You will learn to trouble-shoot and service radios, using the professional Signal Tracer, the unique Signal Injector, and the dynamic Radio and Electronics Tester. Our Consultation Service will help you with any technical problems.

J. Stasaitis, of 25 Popular Pl., Waterbury, Conn., writes: "I have repaired several sets for my friends, and made money. The "Edu-Kit" paid for itself. I was ready to spend \$240 for a course, but I found your ad and sent for your kit."

FREE EXTRAS

- Radio Book • Radio and Electronics Tester • Electric Soldering Iron • Set of Tools • Tester Instruction Book • Hi-Fi Book • Quiz Book • Membership in Radio-TV Club: Consultation Service • FCC Amateur Lic. Training • Printed Circuitry

UNCONDITIONAL MONEY-BACK GUARANTEE
ORDER FROM AD—RECEIVE FREE BONUS RESISTOR KIT WORTH \$5

□ "Edu-Kit" Postpaid. Enclose full payment of \$19.95.
 □ "Edu-Kit" C.O.D. I will pay \$19.95 plus postage.
 □ Send me FREE additional information describing "Edu-Kit." Include FREE valuable Hi-Fi, Radio & TV Servicing Manuals. No money-back guarantee.
 (Outside U.S.A.—No C.O.D.'s "Edu-Kit" for 105-125 V. AC/DC \$20.95; 210-250 V. AC/DC \$23.45)

Name.....
Address.....

PROGRESSIVE "EDU-KITS" INC.

497 Union Ave., Room 123G, Brooklyn 11, N.Y.

TECHNOTES

(Continued)

mal. The clue was found in the partial keystone effect and the other symptoms which indicated yoke trouble. The difficulty was due to the 47- μ f capacitor across half of the yoke winding, which developed a partial short.

With the yoke energy reduced, the bootstrap voltage, which feeds the vertical output and horizontal circuits, is lowered. This in turn reduces both the vertical and the horizontal size.—Peter Millano

CROSLY CUSTOM J

Due to variations in the characteristics of the 3BZ6 tubes in the if stages, it is possible under certain levels for the rf tuner bias to rise above its optimum operating level. When this occurs, the snow level will be higher than normal. To check this, short out the tuner bias at the tuner while the set is tuned to a weak station. If the snow level drops, the tuner bias is too high.

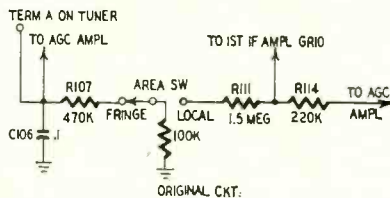

In weak signal areas, where it is not necessary to use the local position to control exceptionally powerful local stations, the following wiring changes (see diagram) will improve signal pickup—if the tuner bias is too high:

1. Remove R111.
2. Transfer R107 from its present lug on the area switch to the switch lug vacated by R111.
3. Connect a lead from the junction of C106 and R107 to the switch lug vacated by R107.

The above change removes the original local position and puts the original fringe (or normal) in its place. The super-fringe position is then put where the original fringe position was.—Crosley Service Instructions

OSCILLATION ON UHF

An RCA 17T200 produced strong oscillations, visible on the screen of the picture tube, when operating on uhf. All tubes in the converter section checked good and all wiring and components appeared normal. I then discovered that the trouble was caused by vibration of the set's metal cabinet against the uhf converter. The solution was simple—I placed strips of rubber tape on the converter mounting brackets.—Henry S. Hartson

Little Devil COMPOSITION RESISTORS

Meet all MIL-R-11A requirements. Rated at 70C rather than 40C. Available in 1/2, 1, and 2-watt sizes in all standard RETMA values.

BROWN DEVIL RESISTORS

Vitreous-enamelled. In 5, 10, and 20-watt sizes.

TYPE AB POTENTIOMETERS

Resistance material is solid-molded, noise-free. Rated at 2 watts.

FR-7.5 FUSE RESISTOR

For easy replacement in all television receivers. 1 1/2" Tinned wire leads.

WRITE FOR STOCK CATALOG

Be Right with

OHMITE

DEPENDABLE RESISTANCE UNITS

Eliminate call-backs due to faulty replacements. Use Ohmite components.

AXIAL-LEAD RESISTORS

Vitreous-enamelled, power-type units designed to withstand high temperatures.

3 WATT SIZE
9/16" x 1/4"

5 WATT SIZE
1" x 11/32"

10 WATT SIZE
1-3/4" x 13/32"

OHMITE

OHMITE MANUFACTURING CO.
3646 Howard Street, Skokie, Illinois

CROSLLEY 431 CHASSIS

This 21-inch chassis came in dead. A quick check uncovered an open heater in the 25CU6. After it was replaced, the heaters lit up for about half a minute—then went out. Another check showed the new 25CU6 heater to be open. I replaced it with another new 25CU6. Again, the heaters lit up and then went out—another burned out 25CU6. Digging out the schematic for the receiver solved the mystery.

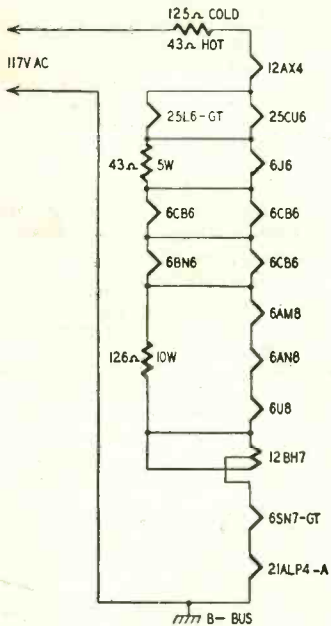

The heater string is connected in series-parallel (see diagram). When the heaters are cold, the series resistance of the entire combination is low, causing more than the rated current to pass through each heater. Eventually, this will burn out one of the heaters, usually the weakest one in the string. If the 25L6 (which caused the trouble in my case) or any of the other parallel-connected heaters burn out, the second parallel heater (the 25CU6) has to carry too much current and, consequently, also burns out. Replacing each tube individually as I did does not help, for the new tube just burns out again. To uncover a defect of this type check the entire heater string for continuity. If one section of a paralleled pair of heaters is open, replace both at the same time. *Warren Smith* END



Here's Why... You Should Buy ... at WRL

... the **NEW hallicrafters**



SX-101: Look at These Feature Points!
Only \$2153 PER MO.

Just 10% Down
Cash Price: \$395.00

We Carry the Full Line of Hallicrafter Equipment. Send for Complete Info

Today!



JUST OFF THE PRESS • NEW FREE 1957 CATALOG
Over 15,000 Bargains for the Amateur, experimenter, etc.
Ask About WRL's new Globe King 500B, Globe Champ, Globe Chief

Please Rush Me:

- Free Catalog, and info on items checked below:
- SX-101 Other Hallicrafter Models
- WRL's Xmtrr. Series

Name: _____

Address: _____

City & State: _____

RE-12
WORLD'S MOST PERSONALIZED ELECTRONIC SUPPLY HOUSE
World Radio LABORATORIES
PM 2-0277
3415 W. BROADWAY COUNCIL BLUFFS IOWA

20 YEARS
of Serving Hams the World Over!

- ✓ Only 10% Down—trade-ins accepted—E-2 Terms—10 Day Trial
- ✓ A WRL Xmtrr. for every ham budget
- ✓ Over 800 reconditioned electronic items with 90 day, new equipment guarantee
- ✓ Highest trade-ins matched or beat
- ✓ Prompt, personalized service! Satisfaction or money back!
- ✓ Full year guarantee on all WRL-manufactured equipment

The World's Largest Distributor of American Radio Equip.

Perma-Power
GOLDEN C-BRITE TV BRITENER

Series or Parallel Booster!

At All Distributors

manufactured by
Perma-Power COMPANY
4727 N. Damen Ave., Chicago 25, Ill.
manufacturers of electronic equipment since 1928
Export: SCHEEL INT., Chicago

"Oh, him, sir?
He's carrying the
JENSEN NEEDLES."

Your choice of school
is highly important
to your career in



**INDUSTRIAL
ELECTRONICS**



**RADIO-
TELEVISION**



**ELECTRONICS
COMMUNICATIONS**

Become an
**ELECTRICAL
ENGINEER**
or an
**ENGINEERING
TECHNICIAN**
at

MSOE in Milwaukee

Choose from courses in:
ELECTRICAL ENGINEERING
Bachelor of Science degree in
36 months. Communications
option (radio-tv) Power option.

ENGINEERING TECHNICIAN
Assoc. in Applied Science degree
— 18 months.
Electronics Communications
Electrical Power.

MSOE — located in Milwaukee,
one of America's largest industrial
centers — is a national
leader in electronics instruction
— with complete facilities,
including the latest laboratory
equipment, visual aid theater,
amateur radio transmitter —
offers 93 subjects in electrical
engineering, electronics, radio,
television, electrical power,
and electricity.

Advisory committee of lead-
ing industrialists. Courses
approved for veterans. Over
50,000 former students.
Excellent placement record.



TERMS OPEN JANUARY,
APRIL, JULY, OCTOBER

Choose wisely — your
future depends on it. Write
for more information today!

MILWAUKEE
SCHOOL OF ENGINEERING
Dept. RE-1256, 1025 N. Milwaukee Street
Milwaukee 1, Wisconsin

Send FREE career booklet.

I am interested in _____ (Name of course)
Name _____ Age _____
Address _____
City _____ Zone _____ State _____
If veteran, give discharge date _____

MS-57

SCHOOL DIRECTORY

LEARN TV SERVICING
UHF—COLOR—VHF

Master the latest, up-to-the-minute
TV and Color TV developments.

You can Earn to \$5,000-\$10,000 a year in TV serv-
icing after a few short months. Education or age
is no barrier. Find out how you can EARN
WHILE YOU LEARN in our big Shops and Labo-
ratories. You work with the latest equipment.
Waste no time with Non-Essentials, Math or De-
sign Theory. Complete information in our new
FREE booklet. Address Dept. E-956. Approved
for veterans. Free Placement Service.

WESTERN TELEVISION INSTITUTE
341 W. 18th St. Los Angeles, Calif.

Dept. E-12-56
Mail me information about training.
Name _____
Address _____

CODE SENDING SPEED
RECEIVING SPEED

Be a "key" man. Learn how to send and
receive messages in code by telegraph
and radio. Commerce needs thousands of
men for jobs. Good pay, adventure, in-
teresting work. Learn at home quickly
through famous Candler System. Quali-
fy for Amateur or Commercial Li-
cense. Write for FREE BOOK.

CANDLER SYSTEM CO.
Dept. 3-0, Box 928, Denver 1, Colo., U.S.A.

RCA INSTITUTES, INC.
A service of Radio Corporation of America
350 West 4th St., New York 14, N. Y.

OFFERS COURSES IN
ALL TECHNICAL PHASES OF
RADIO, TELEVISION, ELECTRONICS
Approved for Veterans
Write Dept. RE-56 for Catalog

ENGINEERING DEGREES
(UNDER AND POSTGRADUATE)
E.E. Option in Electronics
Earned Through Home Study
(Residential Courses Also Available)

PACIFIC INTERNATIONAL UNIVERSITY
(formerly American College of Engineering)
Box 27724-M, HOLLYWOOD 27, CALIF.

**Qualify Yourself as a
HIGHLY PAID
ELECTRONICS SPECIALIST!**

Your present experience
gives you a head start
to a bright career in

**GUIDED MISSILES
AUTOMATION
INDUSTRIAL ELECTRONICS
Advanced Radio-TV**



Today's big money in Electronics goes to men
with complete training... men who are qual-
ified to step up into new career opportunities
which are opening up daily. Nationally recog-
nized, accredited CENTRAL training is de-
signed to qualify you for these good-paying,
responsible jobs in the shortest possible time!

With Central's "Progressive Plan," you start at
the highest technical level your experience per-
mits. Then, each phase of training you complete
prepares you for a better-pay position.

3 Proven Training Plans: (1) Home Study, (2)
Full Resident, (3) Combination Home Study-
Resident. Free, effective nationwide placement
service at every technical level. Join the thou-
sands of Central-trained Electronics Engineering
Technicians now enjoying high-pay careers.
Courses approved for veterans. Mail coupon for
FREE brochure and details.

CENTRAL TECHNICAL INSTITUTE
Dept. Y-126 1644 Wyandotte, Kansas City, Mo.

Name _____
Address _____
City _____ State _____
Phone _____ County _____
If Korean Vet., give approx. discharge date _____

ELECTRONICS 
Prepare for unlimited
opportunities in electronics!
B.S. degree in 27
months. Intensive, specialized courses. Math, electrical
engineering, TV, advanced radio theory & design. Mod.
labs. Low tuition. Self-help. Also Aero., Chemical, Civil,
Electrical, Mechanical Engineering. B.S. degree in 36 mo.
in Math., Chem., Physics, Engineering prep. courses.
G.I. Appr. Enter Dec., March, June, Sept. Catalog
INDIANA TECHNICAL COLLEGE
1512 E. Washington Blvd., Fort Wayne 2, Ind.

**ELECTRONIC TECHNICIANS
ARE IN DEMAND
TRAINED MEN ARE NEEDED**

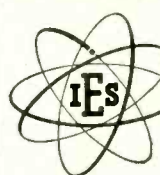
 **IES**

NOW! In just 18 months,
you can complete Electronic
Technicians training to enter
this ever-growing industry.
Day or evening classes. Op-
portunity for employment in
local industry. Approved for
Korean Veterans. Terms beginning Jan., April,
July, September. Write for Catalog 111 TODAY.

INDIANAPOLIS ELECTRONIC SCHOOL
312 E. Washington St. Indianapolis 4, Indiana

TELEVISION
PREPARE FOR A GOOD JOB!
BROADCAST ENGINEER
ELECTRONICS
RADIO SERVICING

Television Servicing
(Approved for Veterans)
BUILDING AIRCONDITIONED
SEND FOR FREE LITERATURE
BALTIMORE TECHNICAL INSTITUTE
1425 EUTAW PLACE, BALTIMORE 17, MD.

**TOP-FLIGHT
ELECTRONICS** 

Train for tech. rep., field engineer,
electronic specialist on missiles, com-
puters, radar, automation, radio, col-
or-TV. Basic and advanced theory
and laboratory. Mathematics. Major
firms select our graduates. Dormi-
tories-campus. 21 months' program.
High school grad. or equivalent. G. I.
approved. Start Jan., April, July,
Sept. Write for catalog.
VALPARAISO TECHNICAL INSTITUTE
Dept. C., Valparaiso, Indiana

wanted career men 

Train for a career instead of a job.
Demand for our graduates exceeds supply.
Effective placement. Modest costs. Small
classes. Well-equipped labs. Beautiful campus.
Approved for Vets. Enter Jan., March, June, Sept.

BACH. SCI. DEGREE IN 27 MONTHS
Complete Radio Eng. courses... TV, UHF,
FM, Electronics. Also Mech., Civil, Elec., Chem.,
Aero. Eng. 36-month B.S. in Bus. Adm. (Gen.
Bus., Acctg., Motor Transport Mgt.)... capable
students faster. Prep courses. Write Jean
McCarthy, Director of Admissions, for
catalog and "Your Career in Engineer-
ing & Commerce."

TRI-STATE COLLEGE
24126 College Avenue, Angola, Indiana

**F.C.C. LICENSE
QUICKLY!**
Home Study or Resident Classes
—FREE DETAILS—

Grantham School, Desk 4-H
1505 N. Western Ave. 821—19th Street N. W.
Hollywood 27, Calif. OR Washington 6, D. C.

Please send me your free booklet, telling how I
can get my commercial FCC license quickly. I under-
stand there is no obligation and no salesman will call.

NAME _____
ADDRESS _____
CITY _____ STATE _____

Patents



INTERMODULATION SUPPRESSION

Patent No. 2,734,950

Carl F. Jordan, Jr., Cedar Rapids, Iowa (Assigned to Collins Radio Corp., Cedar Rapids, Iowa)

This invention relates to systems which carry on communication by tone signals. The receiver in such a system includes several 1-tube amplifiers, each tuned to one of the tone frequencies. When a resonant frequency

is received, the tube in the corresponding amplifier conducts and energizes a relay. Otherwise, it is blocked. During transmission, two or more of the tones may react to cause intermodulation, and the spurious tone may activate one of the stages. This can be pre-

vented as shown in the schematic diagram. A three-stage amplifier is used. Upon receiving a resonant frequency, the corresponding stage conducts and grid current flows through common resistor R. This

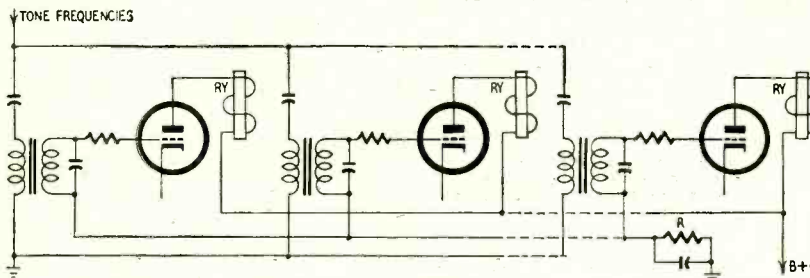

is received, the tube in the corresponding amplifier conducts and energizes a relay. Otherwise, it is blocked. During transmission, two or more of the tones may react to cause intermodulation, and the spurious tone may activate one of the stages. This can be pre-

generates negative bias which is applied to all grids. It also reduces the sensitivity of the tubes, preventing any from responding to intermodulated tones. It does not prevent response to a signal which is always much stronger than the intermodulation.

TV REMOTE CONTROL

Patent No. 2,743,797

Ronald O. Whitaker, Indianapolis, Ind.

Remote control of a TV receiver is difficult because of the many adjustments needed for proper viewing. This novel method controls all essential functions by providing an unusual circuit in which a wound shaded-pole motor does double duty.

This type of motor is similar to the conventional phonograph motor, differing only in that a coil of wire is carried around each shaded pole in place of the usual heavy brass shorting ring. As

operate clutches which engage the motor selectively to the various controls of the receiver. The electrical circuit is shown in the figure. Suppose the viewer desires to switch the set to a higher channel. He will then operate the CHANNEL switch against the upper stop. A circuit is thereby through the clockwise shaded winding and the clutch which engages the motor to the channel selector. The motor starts turning and the receiver is switched to successively higher channels.

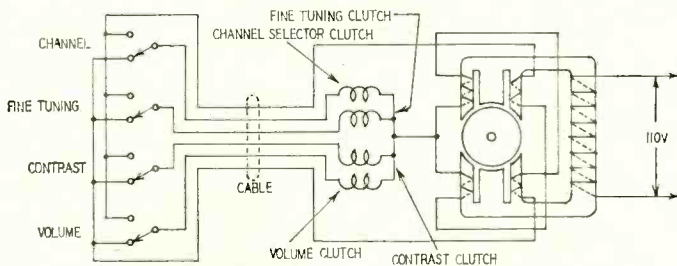

long as the coils are open-circuited, the motor will not turn. As soon as a coil is shorted, the motor turns in the conventional manner. Each coil is effectively the secondary of a transformer of which the field winding is the primary and the motor frame is the core. Hence, it is possible to use the power developed in this "secondary" to operate solenoids, lamps or other types of electrical devices.

This patent uses the power so developed to op-

To switch to lower channels the switch is operated against the lower stop. Other functions are operated in similar manner.

Underwriters' requirements for safety in the control circuit are met since the cable carries only low voltages and is isolated from the line. The system may be extended to provide control of additional functions. Several switch boxes may be placed about the room and wired in parallel to provide control from several positions.

TRANSISTOR AUDIO OSCILLATOR

Patent No. 2,751,501

Everett Eberhard, Phoenix, Ariz. (Assigned to Motorola, Inc., Chicago)

Most audio frequency generators are of the R-C type. These provide good waveform and are generally preferred over circuits using coils for oscillation. The phase-shift method is used here.

V1 is an amplifier connected in common-emitter fashion. Thus it shifts phase by 180°. Its input

impedance is low, its output impedance high. V2 is a common collector which (like a cathode follower) provides no phase shift. Its input impedance is high, its output impedance low. An R-C network couples the V2 output back to the V1 input. The network is designed for a phase shift

Here's how to GET MORE WORK OUT OF YOUR Oscilloscope!

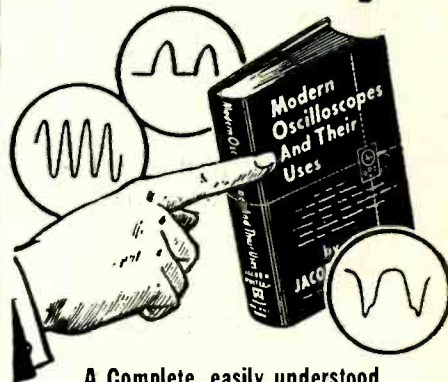

A Complete, easily understood guide to using the handiest service instrument of them all

MODERN OSCILLOSCOPES AND THEIR USES

By Jacob H. Ruiter, Jr.

Enlarged 2nd Edition

... contains the latest data ... everything you need to know about 'scopes!

MORE THAN 30 NEW PICTURES

... plus 50 more pages on use of 'scopes in Color TV servicing Industrial Electronics ... Teaching ... even in Atomic Energy work.

Oscilloscopes are gold mines for servicemen who learn to use them fast, fully and accurately on all types of work—and here is a new, enlarged 2nd edition of THE BOOK THAT REALLY SHOWS YOU HOW.

In clear, easily understood terms, it teaches you when, where and exactly how to use the oscilloscope

... how to interpret patterns ... how to use your 'scope to handle tough jobs easier, faster, and better.

It contains no involved mathematics—no complicated discussions. Instead,

it gets right down to "brass tacks" in explaining how oscilloscopes operate. Then you learn exactly how to use them in lab work and on all types of AM, FM and television service—from locating troubles to handling tough realignment jobs.

WORK EASIER—BETTER—FASTER!

Each operation is explained step by step. You learn to determine just where and how to use the 'scope on specific jobs; how to make connections and adjust circuit components; how to set the controls; and HOW TO ANALYZE OSCILLOSCOPE PATTERNS fast and accurately.

370 illustrations including dozens of pattern photos make things doubly clear.

No other type of specific service training can mean so much to you in boosting your efficiency and earning power! Send coupon NOW for 10-day FREE examination!



'SCOPE EXPERTS get better jobs ... bigger pay!

PRACTICE 10 DAYS—FREE!

DEPT. RE-126, RINEHART & COMPANY, Inc. 232 Madison Ave., New York 16, N.Y.

Send MODERN OSCILLOSCOPES AND THEIR USES for 10-day FREE EXAMINATION. If book is satisfactory, I will then send you \$6.50 plus postage promptly in full payment. If not, I will return the book postpaid in good condition and owe you nothing. (SAVE! Send \$6.50 cash with order and we pay postage. Same 10-day return privilege with money refunded.)

NAME _____ ADDRESS _____ CITY, ZONE, STATE _____

OUTSIDE U.S.A. \$7.00 cash only. Money back if you return book within 10 days.

TECHNICIANS

*Do your plans
for a career include...*

- Challenging work in electronics?
- An opportunity to grow in an expanding organization?
- A long established company?

BELL TELEPHONE LABORATORIES

... a leader in communications research and development now has openings for qualified technical aides in the fields of:

- | | |
|---------------------|-------------------------|
| • Communications | • Fire Control |
| • Radar | • Apparatus Development |
| • Computing Systems | • Guided Missiles |
| • Data Systems | • Specification Writing |
- ...and many others

CHECK THESE BENEFITS

- 2 weeks paid vacation each year; 3 weeks starting with 15 years of service
- Liberal sickness benefits
- Company paid pensions
- Finest of facilities and equipment
- Recreational programs
- 5-day normal work week
- Customary holidays
- Moving expense allowance

If you have had a good basic science training at high school; applicable schooling in a technical institute, armed services school, or equivalent; and preferably 2 or more years of applicable industrial or military experience...

Please send resume, phone or wire to
Bell Telephone Laboratories
General Employment Department R
Mountain Avenue - Murray Hill, N. J.

You will be considered for openings at all of our laboratory locations including Whippany, N. J., New York, N. Y., Massachusetts, Pennsylvania, Maryland, Indiana and North Carolina.

PLEASE STATE LOCATIONAL PREFERENCE

BELL TELEPHONE LABORATORIES

PATENTS

(Continued)

of 180° at some predetermined audio frequency.

V1 amplifies any signal applied to it and feeds it through V2 and the network. If the signal is at the predetermined frequency, it will shift 360° by the time it returns to the input circuit of V1.

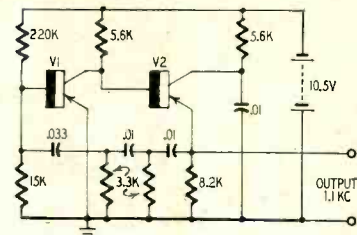

Thus it will reinforce the original signal and generate oscillations. The frequency is determined by R and C values of the network. In the diagram shown, the frequency is 1,100 cycles.

V2 does not amplify but plays an important role in the circuit. Its output matches the low impedance of the R-C network, while its input matches the high impedance of the V1 collector.

UNDERWATER TRANSDUCER Patent No. 2,746,027

James J. Murray, Easthampton, Mass. (May be manufactured and used by U. S. Government without royalty payments)

This sensitive detector of vibrations under water uses a U magnet with wedge-shaped poles for flux concentration. The flux-control element, which consists of a block of rubber in which finely powdered nickel particles are suspended or dispersed, is placed between the poles. When the particles are displaced by a vibration signal they cause flux vibrations. These are translated into a corresponding ac voltage across the coil.

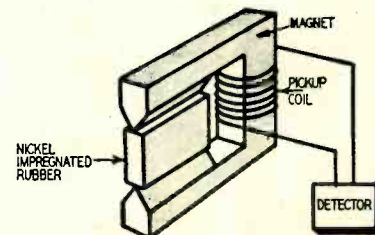

Rubber has approximately the same acoustic impedance as water, so the water vibrations are efficiently converted to ac. The nickel particles cannot be all of the same size and mass. The smaller ones will respond to higher frequencies than the larger ones. The result is a low-Q transducer with a flat response over a wide band of frequencies.

END



Suggested by Garkis Kalfayan, Alexandria, Egypt

"That's a super aerial you've got there."

"Sure! It cost so much I had to sell my set to pay for it."

try
This
one



**CONVERT 78-RPM CHANGER
TO 33 1/3 RPM**

You may have a 78-rpm changer that seldom is used now that 33 1/3-rpm records have become popular. Many of these older changers can be converted to 33 1/3 rpm.

In addition to changing the speed it's usually necessary to replace the phono cartridge and add a sliding counterweight to obtain the correct stylus pressure.

To change the speed, the main drive shaft is filed to a smaller diameter. We recommend that the phono cartridge be replaced with a ceramic cartridge such as the Sonotone model 1P-1S. A sliding counterweight, manufactured by the Mercury Scientific Co., can be added to the old tone arm or you can replace it with a lightweight arm.

As an example of the procedure you might follow, we converted a Webster Chicago 78-rpm changer to 33 1/3 rpm. However we replaced the entire tone arm instead of adding a counterweight to the old arm.

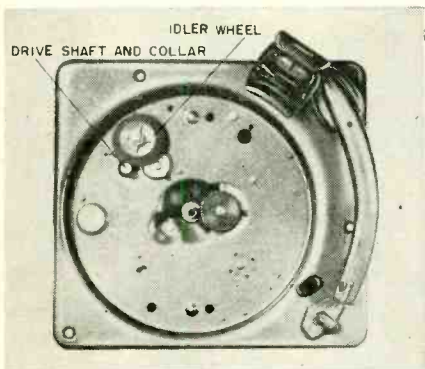

The photo shows the 78-rpm changer as it looked when removed from a radio phono.

As can be seen, the drive shaft has a collar which is held in place by a hex screw. Remove the idler wheel. Then remove the collar with a hex wrench. The turntable speed will be reduced to about 43 rpm.

You are now ready to file. Turn on the motor. Apply the file to the drive shaft with moderate pressure. After filing for a short time replace the idler wheel and turntable. Check the speed with a stroboscopic disc. As the speed approaches 33 1/3 rpm you will want to check it at frequent intervals.

You will be able to play both 78- and 33 1/3-rpm records, with this particular changer, if you file only about 1/4 inch down the drive shaft. It takes only a minute to slip the collar over the drive

Send for MusiCraft's **FREE**
high fidelity

catalog

Just off the press!

Jam-packed
with latest
hi-fi values!



Here's a *special* high fidelity catalog that you'll find particularly useful, because we have included *only* equipment which we at MusiCraft consider the *best*—from the standpoint of *compatibility* and stable operating efficiency—in every price range.

Page after page pictures the newest high fidelity equipment with detailed information about characteristics and specifications.

Whatever you want—whatever you need—speakers, tuners, amplifiers, turntables, "do-it-yourself" kits, etc.—MusiCraft's new catalog features all the top quality components from leading manufacturers.

Send now for your free copy of the new **MUSICRAFT HIGH FIDELITY CATALOG:**

MusiCraft

48 East Oak Street
Chicago 11, Illinois
Delaware 7-4150

name _____
address _____
city _____ zone _____ state _____

**ROBOTS • GAME-PLAYING MACHINES
ELECTRIC-BRAIN CONSTRUCTION KITS
GENIACS, TYNIACS • CONSTRUCTION
PLANS • ETC.**

Find out about the extraordinary power and fascinating variety of computing and reasoning circuits with our kits, publications and courses—actual and robots—\$2 and up.
(See RELAY MOE PLAYS TIT-TAT-TOE, our front cover and story in December 1956 issue.)

MAIL THIS COUPON or facsimile

Edmund C. Berkeley & Associates
815 Washington St., R 180,
Newtonville 60, Mass.

Please send me FREE announcements about your:

- Scientific Kits Publications
 Courses by Mail Small Robots

My name and address are attached.

EASY TO LEARN CODE

It is easy to learn or increase speed with an Instructograph Code Teacher. Affords the quickest and most practical method yet developed. For beginners or advanced students. Available tapes from beginner's alphabet to typical messages on all subjects. Speed range 5 to 40 WPM. Always ready—no QRM.



ENDORSED BY THOUSANDS!

The Instructograph Code Teacher literally takes the place of an operator-instructor and enables anyone to learn and master code without further assistance. Thousands of successful operators have "acquired the code" with the Instructograph System. Write today for convenient rental and purchase plans.

INSTRUCTOGRAPH COMPANY

4701 Sheridan Rd., Dept. RC, Chicago 40, Ill.

ARKAY Kits . . . lead the field

ANOTHER ARKAY FIRST!!

SPECIFICATIONS:
 ELECTRICAL RATING—9 volt transistor energizer
 OPERATING FREQUENCIES
 TUNING RANGE—540 to 1620 KC
 I.F. AMPLIFIER—455 KC
 POWER OUTPUT—275+ milliwatts
 SPEAKER—large alnico V permanent magnet
TRANSISTOR COMPLEMENT
 X1 oscillator-converter
 X2 1st I.F. amplifier
 X3 2nd I.F. amplifier
 D1 diode detector—AGC takeoff
 X4 class B driver
 X5 class B output
 X6 class B output

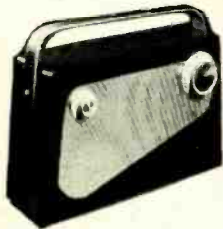

\$37.50

Federal Excise Tax included

introducing

ARKAY Model TR-6 TRANSISTORIZED PORTABLE SUPERHET RECEIVER

The model TR-6 is a newly designed all transistor portable superheterodyne receiver with push-pull Class B output providing clear crisp output better than 275 milliwatts. Construction of the TR-6 is extremely simple because of the advanced engineering techniques employed in its design.



ARKAY Model FL-10 Hi-Fi Amplifier

A super lin. Williamson type 12 watt Hi-Fi amplifier with built-in pre-amp. Push-pull output with a frequency response of 20-40,000 cps. 4 controls including record equalization, (LP, RIAA, EUR). Output impedances, 4, 8, & 16 ohms.

\$28.95



ARKAY Model B-8 Hi-Fi Speaker System

Frequency Response: 10 to 20,000 cps. Crossover Frequency: 1600 cps. Power Rating: 25 watts. Impedance 16 ohms. Features a bass reflex, ducted port enclosure equipped with a low frequency speaker and a compression driven horn of special design. A variable balance control w/network provides smooth continuous adjustment of the H/F speaker.

\$35.95

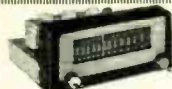

ARKAY Model FM-6 FM Receiver Kit

Extremely sensitive and stable . . . grounded grid front-end; Foster-Seeley Discriminator. Temperature compensated oscillator circuit. 3 double tuned IF stages, limiter and discriminator give top selectivity and sensitivity.

\$25.75

Fed. ex. tax included



ARKAY Model HFI-7 Hi-Fi AM-FM Tuner

Excellent sensitivity and low noise characteristic. Automatic frequency control with provisions for AFC erase. Allows pinpoint, high selectivity tuning. Foster-Seeley discriminator, high efficiency AM loop stick antenna and temperature compensated oscillator circuit.

kit less cover . . . **\$32.00**

Now! Wired and Tested! \$49.95
 COVER FOR ABOVE \$3.95
 Fed. ex. tax incl.



NEW!! ARKAY Model FL-30 Hi-Fi AMP-PRE-AMP

SPECIFICATIONS:

POWER—30 watts @ 1.5% IM
 FREQ. RESPONSE $\pm 1/2$ db 20-40,000 cps
 HUM—120 db, below rated output

CONTROLS—(6) Func. selector, loudness, bass, treble, level set, 5 position level compensation control.

Featuring a transistorized front end for use with a reluctance pick-up, this engineering masterpiece assures the finest in HI-FI reproduction. Record equalization for more than 30 labels (LP, RIAA, & EUR) Complete with rose gold panel and black cabinet.

\$49.95

FREE!

Get the new, big, catalogue and specifications of the remarkable ARKAY line. Now at your local dealer!
 Prices 5% Higher West of the Mississippi

ARKAY · 120 Cedar Street · N.Y.,

ENGINEERING

B. S. DEGREE IN 27 MONTHS

Prepare for unlimited opportunities of the Electronic Age! Earn your B.S. degree in 27 months at Indiana Technical College. Intensive specialized course. Comprehensive training in electronics, television, advanced radio theory and design, math and electrical engineering. Modern laboratories. Low rate. B.S. DEGREE IN 27 MONTHS in Aero., Chem., Civil, Elec., and Mech. Engineering; in 36 MO. in Matl., Chem., Physics. Also Eng. Sc. preparatory courses. G. I. appr. Enter Dec., March, June, Sept. Earn part of your expenses in Fort Wayne. Catalog.

INDIANA TECHNICAL COLLEGE
 1712 E. Washington Blvd., Fort Wayne 2, Indiana
 Please send me free information on B.S. ENGINEERING DEGREE IN 27 MONTHS as checked.

Electronics Chemical Aeronautical
 Civil Mechanical Electrical
 B.S. DEGREE IN 36 MO. in: Math. Chem. Physics

Name _____
 Address _____



MUST MOVE OUR WAREHOUSE

Set Builders — Experimenters

GIANT SURPRISE KIT \$4⁹⁵

25-30 lbs. of brand new RADIO PARTS . . . no junk . . . Transformers, Filter and Bypass Condensers, Resistors; Wirewound, Carbon, Volume Controls, Sockets, Wire, Variables, Chassis and Gang Switches. Parts that every Service Man, Experimenter or Ham needs. Express or Freight Shipments Only. No C.O.D.

NEWARK SURPLUS MATERIALS CO.

324 PLANE ST., Newark, N. J.

TRY THIS ONE

(Continued)

shaft and tighten the hex screw to change back to 78-rpm operation.

When the speed has been reduced to about 34 rpm, replace the tone arm and phono cartridge. Now begin checking the speed with the turntable loaded and the needle tracking on a record.

The new arm is a G-E 22X084-2. Plug-in heads are used with it. The net cost of the arm and plug-in head is around \$3.25.

Note how the old arm is mounted. You may want to draw a simple sketch. The new arm is mounted in the same manner as the old. Don't forget to adjust the indexing and the tracking pressure after you install the new arm.

You may have a 78-rpm changer that can be converted just as easily. Arms for turnover cartridges and plug-in heads are available for other popular makes of changers.—Frederic T. C. Brewer

PORTABLE WIRE RACK

Here's a handy little box holding six spools of wire which you can carry right to the job or from one bench to another in the lab. The wire can't get tangled and the six ends are always protruding from the top, ready for use.

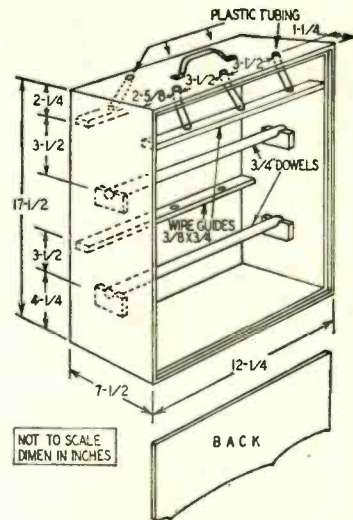

The box is easy to build, having 1/2-inch sides, top and bottom. A rabbet all the way around allows the 1/4-inch plywood front and back panels to set in flush. The front one is nailed in place, while the back one is clipped in place. Two 3/4-inch hardwood dowels hold the wire spools, and the wire is fed up through the wire guides.

The wire from the bottom spools comes up through the holes in the lower wire guide and then is threaded through the top guide and out through the top. Between the top wire guide and the top of the cabinet are six lengths of heavy plastic tubing of 5/32 inch inside diameter and 9/32-inch outside. This serves as a brake to prevent the wire from being pulled too fast and to keep it from falling back after cutting. The holes in the lower guide are 1/4-inch in diameter and those in the upper guides and top are 5/32-inch with a

TRY THIS ONE

9/32-inch counterbore to hold the tubing in place.

Brass eyelets can be pressed in the holes in the top. Six turns of No. 14 music wire springs, 1- to 1½-inch in

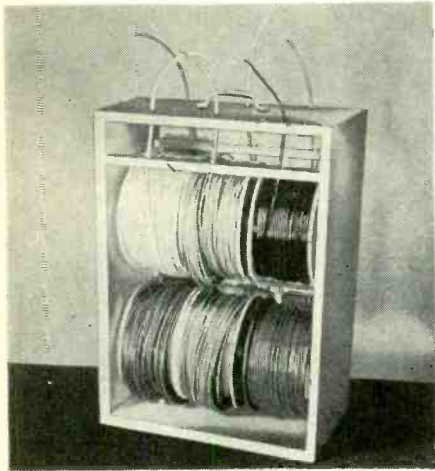

diameter, are placed between the spools to keep tension on them and to prevent one from turning another. Four of these springs are required. A coat of gray paint, a handle on top and four rubber feet complete the cabinet.—*Karl Greif*

TV LEAD-IN SPLICES

To save yourself that extra trip back up on the roof when repairing or installing a TV antenna—be careful when you tape any lead-in splices. Taping the connection is where you are most likely to get into trouble.

(Continued)

The 300-ohm ribbon line is usually made up of a number of strands of fine copper wire. The first thing an installation man usually does when starting to make a splice is to cut and trim the wire ends so they are of the proper length, using, of course, his diagonal cutters. Next, comes the joining and twisting together the ends of the lead-in. Now you reach for the roll of electrical Scotch tape. You fish in your pocket for the wire cutters. Finding them you snip off a few inches of tape and begin to wrap . . .

The first wrap around is the one that counts because, if you haven't been paying attention, there is a good chance that the adhesive surface of the tape has picked up at least one strand of the fine copper wire nipped from the lead-in when we were matching our ends; transferred so innocently from the jaws of the diagonals! You can guess the rest. On several occasions this has happened to me and that strand caused a first-class short.—*George D. Philpott*

FEET PROTECT TEST SETS

I find that a piece of ½-inch foam rubber cemented on the bottom of my test instruments greatly reduces the amount of jarring and jolting that they take while being moved around. It also tends to reduce the chance of cracking a case and to lengthen the life of the instrument.—*Robert L. Beyer* END

**ALL NEW
BIGGER THAN EVER!**



**NEWARK'S
Complete
ELECTRONICS
Catalog No. 65**
Here's everything in Industrial Electronics, High Fidelity, Radio, TV and Amateur Equipment

Write today



Mail Order Division . . . Dept. RE-12
223 W. Madison St., Chicago 6, Illinois
4736 W. Century Blvd., Inglewood, Calif.

COYNE QUALITY
TELEVISION
RADIO - COLOR TV
Home Training
at Unbelievably Low Cost



The future is **YOURS** in TELEVISION!
A fabulous field—good pay—fascinating work—a prosperous future in a good job, or independence in your own business!

Coyne brings you MODERN-QUALITY Television Home Training; training designed to meet Coyne standards at truly lowest cost—you pay for training only—no costly "put together kits." Not an old Radio Course with Television "tacked on." Here is MODERN TELEVISION TRAINING including Radio, UHF and Color TV. No Radio background or previous experience needed. Personal guidance by Coyne Staff. **Practical Job Guides** to show you how to do actual servicing jobs—**make money early in course**. Free Lifetime Employment Service to Graduates.

COYNE
ELECTRICAL SCHOOL
A TECHNICAL TRADE INSTITUTE OPERATED NOT FOR PROFIT
500 S. Paulina Street, Chicago 12, Dept. 96-HT4



Send Coupon for Free Book

and full details, including easy Payment Plan. No obligation, no salesman will call.



COYNE Television Home Training Division
500 S. Paulina St., Chicago 12, Ill.
Dept. 96-HT4

Send Free Book and details on how I can get Coyne Quality Television Home Training at low cost and easy terms.

Name _____
Address _____
City _____ State _____

STAN-BURN E-D-A-R-K-E

CATHODE RAY TUBE SPECIALS ONE YEAR GUARANTEE

G.E.	Type	STAN-BURN	G.E.	Type	STAN-BURN
\$15.80	10BP4	\$10.00	\$30.75	17CP4	\$20.50
19.10	12LP4A	13.95	33.90	17GP4	21.50
12.00	12QP4	10.00	24.75	17FP4	18.00
18.75	12UP4	15.00	37.00	19AP4A	24.00
20.75	14CP4	13.75	28.35	20CP4A	18.95
15.00	14SP4	14.50	32.10	20CP4B	21.95
33.75	16AP4	18.50	36.00	21AP4	25.00
32.20	16DP4A	15.25	29.75	21EP4A	20.15
23.50	16KP4	15.75	33.50	21EP4B	23.25
37.20	16KP4A*	18.75	30.90	21FP4	21.15
33.75	16GP4	18.75	37.00	21MP4	26.25
31.50	16LP4A	15.25	29.75	21YP4	22.00
31.50	16WP4	15.25	100.00	24AP4	56.00
23.50	17BP4	15.75	46.60	24CP4A*	38.00
27.50	17BP4B*	18.75	48.20	24DP4A*	39.00

*Aluminized
INQUIRE FOR ANY TUBE TYPE NOT LISTED
STAN-BURN CRT TUBES RCA LICENSED—Mid. by Lincoln
PRICES SUBJECT TO CHANGE WITHOUT NOTICE

\$20 WORTH OF ELECTRONIC PARTS IN GRAB-BAG
consisting of: Porcelain sockets, coils, speaker, trans
resis, cond. ONLY \$1.98 (plus 50c postage)

TAPE RECORDERS—Famous Brand
List Pr. \$249.95 \$169.00 List Pr. \$129.95 \$79.95
List Pr. 199.95 129.00 List Pr. 79.95 59.95
Write for complete illustrated details.

KITS: We stock the following manufacturers
complete line of kits—see reference pages.
EICO.....see pages 31-32 ARKAY.....see page 144
QUALITY.....see page 146 PRECISE.....see page 113
All domestic orders will be shipped prepaid for a
limited time. Send us your list. Order by Manufacturer
and Model Number of item.

**MAJESTIC-GRUNDIG STARLET-AM-FM TABLE MODEL
RADIO** Brilliant 7 tube perf.-1 selenium rect. plus 2
germanium rect.-large dynamic speaker-Choice of 3
colors: Mahog., Pastel Green or Ivory.....\$49.95

**STERLING HI-FI-6 TUBES-AM-FM SHORTWAVE-
5 watt output, phono jack with push button switch,
extra speaker jack, extra treble controls, built-in
antennas, beautiful plastic cabinet in various colors.....\$29.95**

**MITCHELL-HI FIDELITY CONSOLETT-2 SPEAKERS
(1-8" and 1-4"), wide range ceramic cartridge with
turnover sapphire needles, special push-pull ampli-
fier, Incl. tone controls for emphasis and bass com-
pensated vol. control, MAHOG. (Incl. legs).....\$64.50
BLONDE (Incl. legs).....\$44.50**

**MAJORETTE-3 SPEED MANUAL-AMPLIFIED REC-
ORD PLAYER** in carrying case.....\$13.49
Same as above with t/over cartridge.....14.95

MODEL 756-"HONOLU" PHONOGRAPHS
Changer-Dual speakers, t/over cartridge with sapphire
needles, outside controls for tone and volume, 3 tube
amplifier, in beautiful tone green leatherette case.....\$46.50
**MODEL 856-"HI FI"-4 SPEED-DELUXE VM AUTO-
MATIC Changer-Ceramic cartridge with t/over sap-
phire needles, precision amplifiers-5 1/2" and 6"
matching speakers- Palomino tan leatherette case with
outside controls.....\$56.50**

Write for literature and dealer price lists on STERLING-MAJESTIC GRUNDIG-MITCHELL-PHONOLA-
WILCOX-GORET lines.

**VM 4 SPEED HI-FI CHANGER—Model 1210 with
Ronette, Sonolone, Astatic flip-over cartridge.....\$22.95**
RC 456 4-speed Collaro, BRAND-NEW, Special.....\$29.95
45 RPM SPINDLE for above.....\$2.98

**4 SPEED PORTABLE RECORD PLAYER with MONARCH
CHANGER—Ronette cartridge—Two Tone Case \$33.95**

**VM 4 SPEED portable changer ampl. with 2 tube
amplifier.....\$39.95**

**WESTERN 4-speed "Magic Mind" automatic Ronette,
Sonolone or Astatic flip-over cartridge.....\$24.95**

**MONARCH 4 SPEED AUTO. INTERMIX
CHANGER with crystal cartridge.....\$22.95**
Same with British variable reluctance.....25.95
45 RPM SPINDLE.....1.88

**TU-8 MONARCH 3 SPEED MOTOR & TURN-
TABLE UNIT (less arm).....4.95**

**PORT-O-PAL PORTABLE BATTERY OPERATED RADIO
4 TUBE IMPORT, less batteries.....\$13.95**
3 WAY AC/DC & less batt.\$17.95
BATTERY KITS for above.....\$2.00

SONORA-4 TUBE SUPER HET-AC/DC-EBONY \$11.50
Above in RED, WHITE, MAHOG. 12.50
SONORA-17" TABLE MODEL TV.....\$88.82

AUTO ANTENNAS AND SPEAKERS
UNIVERSAL 3 sect.—48" lead.....ea. \$2.25
Lots of 10 ea. 2.00
UNIVERSAL 2 sect.—54" lead.....ea. 1.75
Lots of 10 ea. 1.50

**REAR SEAT SPEAKER KITS complete with Grille,
Wired switch, mounting hardware, etc. 6 x 9 \$5.00**
5 x 7.....4.50

HI-FI PACKAGE DEAL
Includes: JENSEN K210 SPEAKER, MONARCH AUTO-
MATIC CHANGER with GE RFX-050 12" SPEAKER
ENCLOSURE in BLOND or MAHOGANY WOOD (Specify
color) MATCHING BASE FOR CHANG-
ER, 10 WATT HI-FI BOGEN AMPLI-
FIER. Complete, ready to play. A
\$135.00 Value for Only.....\$99.50 net
or your choice of similar units at relative package
price. Write for prices. Specify choice of components.

DEALERS: Write for low cost prices and catalogs
on 156 models—HALLICRAFTERS, SUPERMETRO,
NATIONAL, PRECISION, HICKOCK, TECHMASTER,
G.E., WESTINGHOUSE, TUNG-SOL, MAJESTIC,
GRUNDIG, ARKAY, KITS, DELCO, GEN. MOTORS.
Address all inquiries to Dept. RE-12.

**COMPLETE HIGH FIDELITY DEPARTMENT. SEND US
YOUR LIST FOR LOWEST QUOTATIONS ON ANY ITEM**

We invite export inquiries and offers. Our export de-
partment will give special attention to expediting
foreign orders at minimum commissions. We are
authorized distributors for United Motors, all Delco
and Gen. Motors Auto Radio parts in stock.

We also carry a complete line of popular makes of
Radio Tubes at 50/10 discount. Also many other
special purpose and transmitting tubes, and all elec-
tronic parts and equipment at lowest prices. Send us
a list of your requirements for prompt quotations.
Terms: 20% with order. Balance C.O.D. All prices
F.O.B., NEW YORK Warehouse. Minimum order \$5.00.
Write for our latest price list and Hi-Fi Catalog RE-12.
All Prices Subject to Change Without Notice

**STAN-BURN RADIO and
ELECTRONICS CO.**
558 CONEY ISLAND AVE. • B'KLYN 18, N. Y.

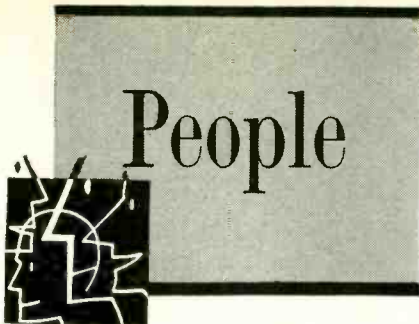

J. R. Johnson was promoted to vice president in charge of sales and merchandising for Standard Coil Products Co., Melrose Park, Ill. He had been assistant to the president. Photo shows



Oden Jester (left), assistant general sales manager of Standard, congratulating Mr. Johnson.

Dr. Harvard L. Hull joined Litton Industries, Beverly Hills, Calif., parent company of Triad Transformer Co., as a vice president. He comes to Litton from Farnsworth Electronics Co., of which he had been president.



Richard P. Thornton joined Amphenol Electronics Corp., Chicago, as marketing manager for the aircraft and guided missile industries. He was formerly

associated with Ingersoll-Rand, P. R. Mallory and Westinghouse.

Jay Carver was promoted to the post of advertising and sales promotion manager for Electro-Voice, Inc., Buchanan, Mich. He came to the company early this year as manager of wood product sales, from the Cabinet Division of G & H Wood Products, where he was advertising manager.



Chester C. Pond was promoted to manager—product planning of the Philco Government & Industrial Division, Philadelphia, Pa. He had been product manager—special products and coordinator for sales efforts in the development of transistor and semiconductor business.

Build it Yourself!



Spinnet, two-manual and three-manual electronic organs. Save hundreds of dollars with our easy-to-assemble kits. Designed to sound and look like a pipe organ.

Send \$1.00 for "Organ Builders Manual." Full plans for home, church and concert models. Includes parts catalog.



ELECTRONIC ORGAN ARTS Dept. 12,
4878 Eagle Rock Blvd. • Los Angeles 41 Calif.

BE QUALITY WISE... BUY QUAL-KITS!



HI-FI AMP. KIT
Complete 6 tube-10 watt amplifier. Push-pull beam power output, built-in pre-amp 5 position selector switch, 3 position record equalization, LP, RIAA, Eur. Response 1/2 db, 20-20,000 cps. Output 10 watts at less than 2% IM. Low noise level and harmonic distortion. \$28.50



HI-FI AM-FM TUNER KIT
Advanced 7 tube circuit plus Rectifier for full sensitivity and selectivity. Distortion less than 1%. Sensitivity is 5 uv for 30 db quieting on FM, 25 uv AM. Armstrong FM Circuit with limiter. Foster-Seelye Discriminator. 20-20,000 cps response. Full AFC control—no drift. Easy assembly. \$28.95*

Every kit complete with 28 page fully illustrated instruction and assembly manual. Cover and legs optional.

Write for FREE catalog and name of nearest dealer carrying these remarkable units.

*Add 10 Percent for new federal tax
QUALITY-ELECTRONICS
319 Church St. Dept. E12 New York 13, N. Y.

BUY CHRISTMAS SEALS

CRYSTAL CONTROLLED CONVERTERS

POLICE • FIRE • COMMERCIAL



- ✓ Precision—Stability
- ✓ Sensitivity
- ✓ Easy Installation

\$32.50

• A compact converter supplied with commercial tolerance crystals, self contained automatic noise limiter. Also models with squeelch. Ideal for mobile or home use.

TUNERS

Enjoy FM Programs While You Drive.

- FM BROADCAST
- 30-50 MC
- 108-176 MC

from \$22.50

WRITE FOR LITERATURE

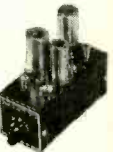

KUHN ELECTRONICS
20 GLENWOOD CINCINNATI 17, OHIO



Barton Kreuzer, (left) director of product planning for RCA, Camden, N. J., was elected president of the Society of Motion Picture & Television Engineers. Dr. Alfred N. Goldsmith (right), a former RCA executive and now a consultant, received the society's highest award for the year, the Progress Medal.

Obituary

Robert A. Johnson, general manager of Hexacon Electric Co., Roselle Park, N. J., in Overlook Hospital, Summit, N. J., after a short illness.

John S. Mills, at one time vice president in charge of sales and advertising for Tele-Tone Radio Corp. and president of Rico Television Corp. and an executive with several other well-known firms, in Miami Beach, Fla. He recently established Mills Electric-Dynamics Corp. in Coral Gables, Fla., for the manufacture of hi-fi systems.

Personnel Notes

... Milton R. Schulte, vice president and director of Tung-Sol Electric Co., Newark, N. J., was elected to the new post of executive vice president.

... Brig. Gen. David Sarnoff, chairman of the Board of Directors of RCA, was feted at a dinner in New York on his 50th anniversary in electronics.

... Lawrence G. Haggerty, former president of Capehart-Farnsworth Co., was named president of Farnsworth Electronics Co., Fort Wayne, Ind.

... Glen McDaniel, RETMA's general counsel, was reappointed chairman of the association's Legal Committee. Joseph A. Hatchwell, Allen B. Du Mont Laboratories, was named chairman of the Service Committee, and Julius Haber, RCA, was reappointed chairman of the Public Relations and Advertising Committee.

... Don Larson was chosen business manager of the Western Electronic Show and Convention (WESCON). He has been general manager of the West Coast Electronic Manufacturers Association, co-sponsor of the WESCON. He will continue in that capacity until a successor is appointed.

... Raymond B. George, vice president-merchandising of Philco Corp., Philadelphia, Pa., was named vice president-sales promotion, and Max Enelow, advertising counsel, was named advertising manager, in a move to set up separate sales promotion and advertising departments.

... Dudley A. Hansen was appointed technical advisor and special assistant to the president of Phaotron Instrument & Electronic Co., South Pasadena, Calif. He will supervise Government contracts. Hanson is well known in the meter industry. END

IT'S THE BIGGEST AND BEST EVER

FREE THE GIANT ALL NEW 1957 BA CATALOG

A COMPLETE BUYING GUIDE FOR EVERYTHING IN . . .

RADIO • TV ELECTRONICS

1957

BA

SINCE 1927

172 KING-SIZED PAGES

EVERYTHING IN RADIO TV AND ELECTRONICS

100'S OF NEW ITEMS LISTED HERE FOR 1ST TIME

21 PAGES OF BARGAINS NOT IN ANY OTHER CATALOG

RUSH COUPON TODAY!

BURSTEIN-APPLEBEE CO. Dept. S.
 1012-14 McGee St., Kansas City 6, Mo.

Send Free B-A Catalog No. 571.

NAME _____

ADDRESS _____

CITY _____ STATE _____

Buy and use Christmas Seals . . .

Fight Tuberculosis!

RADIO - ELECTRONICS

For Libraries
 Current yearly volume to be available on microfilm.
 Write for information.

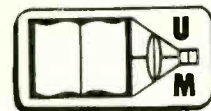

UNIVERSITY MICROFILMS
 ANN ARBOR, MICHIGAN

XCELITE Hand Tools
PREFERRED BY THE EXPERTS

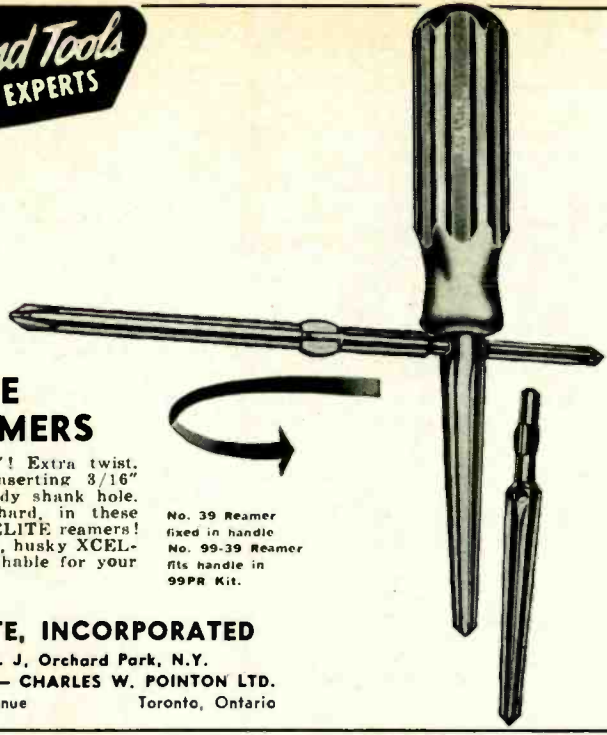

XCELITE SUPER-REAMERS

Capacity up to a big 1/2"! Extra twist, when you need it, by inserting 3/16" screwdriver or pin in handy shank hole. Cutting edges? Chrome-hard, in these durable chrome-plated XCELITE reamers! Ask for No. 39 fixed in big, husky XCELITE handle or 99-39 detachable for your 99 or 99-Junior set.

No. 39 Reamer fixed in handle
No. 99-39 Reamer fits handle in 99PR Kit.

XCELITE, INCORPORATED
Dept. J, Orchard Park, N.Y.
In Canada — CHARLES W. POINTON LTD.
6 Alcina Avenue Toronto, Ontario

ELECTRONIC COMPUTERS

Wired or kitform. "MINILOG", the miniature analog computer, will solve algebra and differential equations. Electric Sliderule \$14.95. Complete instructions in digital and analog computers. Lifetime free research for graduate students. Write for FREE copy of "ELECTRONIC BRAIN EXPERIMENTER" mag.

Electronic Brain Enterprises
1015 Atkin Avenue, Salt Lake City 6, Utah

REVOLUTIONARY TEST CONNECTOR



Ask your Jobber for E-Z Hook Test Probes. Amazingly simple . . . fully insulated . . . patented Hook type design . . . nothing like it. Greatest improvement in selfholding connectors in years. New . . . different operating principle. Scientifically designed for better, safer connections. It's terrific. Get one today. E-Z Hook Test Products, 1536B Woodburn, Covington, Ky.

for everything in **hi-fi**
GET THE MONEY-SAVING 1957
ALLIED CATALOG

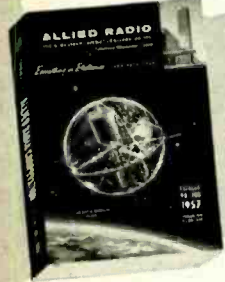

featuring the world's largest stocks of systems & components

free!
SEND FOR IT

Here's your complete money-saving guide to Hi-Fi. Shows you how to select a custom Hi-Fi music system for your home at no more than the cost of an ordinary phonograph. Tells you what to look for and how to save money. Offers the world's largest selection of complete Hi-Fi systems as well as individual amplifiers, tuners, changers, speakers, enclosures and accessories. Want to build-your-own?—see the famous Hi-Fi KNIGHT-KITS. For everything in Hi-Fi—for everything in Electronics, get the FREE 1957 ALLIED Catalog.

ALLIED RADIO AMERICA'S HI-FI CENTER

ALLIED RADIO CORP. Dept. C-126
100 N. Western Ave., Chicago 80, Ill.
 Send FREE 1957 ALLIED Catalog

Name _____
Address _____
City _____ Zone _____ State _____

SURPLUS RADIO CONVERSION MANUALS



Data found in these books has become standard for most commonly used items of surplus electronic equipment.

VOLUME I: Freq. Meter — BC-342 Rcvr. — BC-348 Rcvr. — BC-312 Rcvr. — BC-412 Oscilloscope as a test scope or as a TV Rcvr. — BC-645, 420 Mc. Xmitter/Rcvr. — BC-453A Series Rcvrs. — BC-457A Series Xmitters — SCR-522 144 Mc. Xmitter/Rcvr. — TBY Transceiver with Xtal Control — PE-103A Dynamotor — BC-1068A V-h-f Rcvr. — Electronics Surplus Index — Cross Index of VT-No. tubes.

VOLUME II: ARC-5 and BC-454 Rcvrs. for 28 Mc. — ARC-5 and BC-457 Tx for 28 Mc. Mobile — ART-13 and ATC Xmitter — Surplus Beam Rotating Mechanisms — Selenium-Rect. Power Units — Hi-Fi Tuner from BC-946B Rcvr. — ARC-5 V-h-f Xmitters — GO-9 and TBW Xmitters — 9-W Amplifier from AM-26 — TA-12B and TA-12C Xmitters — AVT-112A Aircraft Xmitter — BC-375 and BC-191 Xmitters — Model LM Freq. Meter — Primary Power Requirements Chart — ARB Rcvr. (Diagram Only)

\$2.50 per volume

*Plus any tax.



BUY FROM YOUR DISTRIBUTOR
Add 10% on direct mail orders to
EDITORS and ENGINEERS, Ltd.
Summerland 3, California

Business



Merchandising and Promotion

Amphenol Electronics, Chicago, is featuring a new five-color counter dis-



play to promote its "Tele-Couplers," an accessory which couples two TV sets to one antenna.

RCA president, Frank M. Folsom, awarded the President's Cup to five winners in its recent national contest for service technicians on ways of increasing customer satisfaction.

Westinghouse Electronic Tube Division, Elmira, N. Y., recently held a travel contest for its tube distributors. All-expense trips to the Caribbean will be awarded to the top winners and their wives.

Winegard Co., Burlington, Iowa, launched an all-out advertising and promotion campaign on its new 1957



line of outdoor TV antennas. A heavy consumer campaign is included, backed by a complete dealer support plan including various types of sales aids.

Astron Corp., East Newark, N. J.,

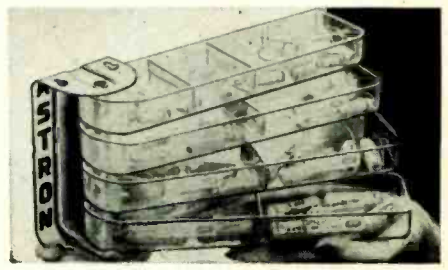

has added the Swing Bin Baby plastic storage and display case to its sales aids for its Blue Point capacitors.

General Electric Tube Dept., Schenectady, N. Y., designed a new functional

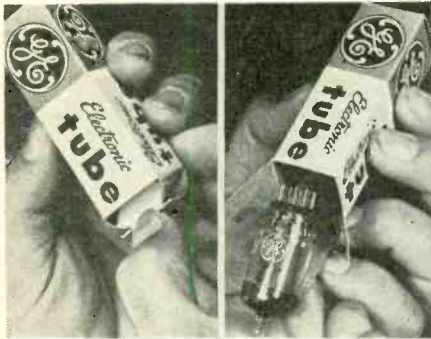

carton for its tubes which gives added visibility, protection and ease of handling.

ORRadio Industries, Opelika, Ala., is offering recording tape dealers a



decals to identify them as "Irish" Brand dealers.

V-M Corp., Benton Harbor, Mich., has scheduled a heavy Key Quarter consumer advertising campaign backed up by a complete dealer sales promotion package in an effort to boost sales in the period from Nov. 15 to Feb. 15.

Production and Sales

RETMA reported the manufacture of 4,365,060 television sets and 8,216,707 radios for the period from January through August, 1956. This compares with 4,820,991 TV sets and 8,707,477 radios for the like period in 1955. Retail sales for this period totaled 3,839,718 TV sets and 4,649,454 radios, exclusive of automobile sets, as compared with 4,171,139 TV sets and 3,189,608 radios for the first eight months of 1955.

RETMA announced manufacturers' sale of 6,837,728 TV picture tubes and 303,004,000 receiving tubes for the first eight months of 1956. This compares with 6,478,351 picture tubes and 300,080,000 receiving tubes in the period from January through August, 1955.

Mergers and Acquisitions

L. A. Young Spring & Wire Corp., Detroit, purchased the assets of Gonset Co., Burbank, Calif., manufacturer of communications equipment. Faust R. Gonsett, former president, became general manager of the Gonsett Division of L. A. Young.

Sprague Electric Co., North Adams, Mass., acquired a controlling interest in CREAS, an Italian capacitor manufacturer. END

DO YOU WANT A BETTER AMPLIFIER?
Build a 50 watt DYNAKIT Mark 11



A premium kit for the audio perfectionist, the Dynakit sounds better because it is designed for outstanding transient response and stability, for higher power at low distortion, and for complete and accurate reproducibility. The improvement over conventional circuits is immediately apparent to the discriminating listener. The Dynakit combines unequalled quality with economy and simplicity. It features the finest of parts, like the superb Dynaco A-430 output transformer. At the same time construction is greatly simplified by the Dynaco pre-assembled printed circuit unit which includes the major portion of the wiring.

\$69⁷⁵
net

The Dynakit is sold complete with all parts and the pre-wired printed circuit assembly. Complete specifications are available on request.

USE A DYNACO TRANSFORMER TO MODERNIZE YOUR PRESENT AMPLIFIER

Dynaco super-fidelity transformers are a new design which permits lower distortion and wider frequency response in high fidelity amplifiers. Models are available from 10 to 100 watts including the 50 watt A-430 transformer which can be used to increase the power of Williamson Amplifiers to 50 watts.

MODELS	
A-410 10 watts 6V6, EL-34	\$14.95
A-420 25 watts KT-66, 5881, EL-34	19.95
A-430 50 watts 6550, EL-34 (6CA7)	29.95
A-440 100 watts 6550	39.95
A-450 100 watts PP par 6550, EL-34	39.95

(all with tapped primaries except A-440 which has tertiary for screen or cathode feedback)
Full data and details of Williamson Amplifier conversion available on request.

AVAILABLE FROM
ELECTRONIC PARTS AND
AUDIO DISTRIBUTORS

DYNA CO. Dept. RE, 5142 Master St.
Philadelphia 31, Pa.

LMB BOX CHASSIS OFFERS FREE
inside LMB boxes

10 tested kit diagram projects for the builder. Each one of these kit diagrams built by a recognized expert. Kit projects are complete in every detail. Circuit diagram, photo of project both front and rear photo. Rear photo shows wiring and parts. Detailed instructions for building, complete parts list and approximate cost. Complete to build except parts and your distributor can supply the parts. Ask your distributor for the list of LMB kit Diagram Projects. If he does not have them, write to

LMB 1011 Venice Blvd.
Los Angeles 15, Calif.

Grips the screw!
Drives it too!

Quick-Wedge
SCREW-HOLDING
SCREWDRIVER



2" to 14" blades, 4 bit sizes
Unconditionally Guaranteed

ASK FOR IT AT YOUR DEALER
Kedman Co., 233 So. 5th W., Salt Lake City

THE BOOK THAT MAKES IT

EASY TO PASS FCC LICENSE EXAMS!



LICENSE MANUAL FOR RADIO OPERATORS by J. Richard Johnson (W2BDL) gets right down to "brass tacks" in helping you pass FCC commercial operator license examinations. Covers all 8 examination subjects — NOT just some of them. Reviews almost 2200 typical questions. Gives easy-to-remember answers. Brings you full details of communications laws plus other needed data from electrical fundamentals to navigation.

ONLY \$5.00
No lessons to wait for

Get your "ticket" for good-pay commercial jobs!

EXTRA BONUS!

32-page supplement included at no extra cost. Gives details of recent changes in Exam Elements 1 and 2.

A COMPLETE GUIDE No lost time! No lessons to wait for! In every respect, this low-cost 430-page book is a complete guide for FCC 1st, 2nd, or 3rd class — phone or telegraph licenses. It helps you get your "ticket" easier, faster and at absolute minimum study cost.

10-DAY FREE EXAMINATION

Dept. RE-126, RINEHART & COMPANY INC.
232 Madison Ave., New York 16, N. Y.
Send Johnson's LICENSE MANUAL plus new 32-page free supplement for 10-day examination. If I like books, I will promptly send \$5.00 (plus postage) in full payment. Otherwise, I will return them postpaid and owe nothing.

Name.....
Address.....
City, Zone, State.....
OUTSIDE U.S.A.—\$5.50 cash—same 10-day return privilege.



Friction
free
as a
feather
in air

REK-O-KUT TURNTABLE ARM

Pat. Pending

A-120 for records up to 12" \$26.95
A-160 for records up to 16" \$29.95
slightly higher west of Rockies

LATERAL FREEDOM FROM FRICTION
achieved by unitized sealed-in
twin-bearing pivot.

FRICTION-FREE VERTICAL SUSPENSION
between 1 mm chrome-steel
bearings... sealed in cross-shaft!

ENDS NEED FOR STYLUS PRESSURE
GAUGE! With cartridge mounted
and arm in state of balance...
turn micrometer-action counter-
weight to build up stylus pressure.



See your dealer or write:

**REK-O-KUT
COMPANY, INC.**

38-01 Queens Blvd., Long Island City 1, N. Y.
EXPORT: Morhan Exporting Corp., 458 B'way, N. Y. 13
CANADA: Atlas Radio Corp., 50 Wingold Ave., Toronto 10

OPPORTUNITY ADLETS

Rates—5c per word (including name, address and initials) Minimum ad 10 words. Cash must accompany all ads except those placed by accredited agencies. Discount, 10% for 12 consecutive issues. Misleading or objectionable ads not accepted. Copy for Feb. issue must reach us before Dec. 15, 1956.

RADIO-ELECTRONICS,

154 West 14 St., New York 11, N. Y.

HIGH-FIDELITY SPEAKERS REPAIRED. Amprite Speaker Service, 70 Vesey St., New York 7, N.Y. BA 7-2580.

FOR SALE—Government Surplus Electronics: Radios; Radio Telephones; Radar; Transceivers; Shop Equipment; Supplies—Direct from U.S. Government Depots—List & Procedure \$1. HRODY, Box 8-REA, Sunnyside 4, N.Y.

OFFICE AUTOMATION: Prepare for the future with the only home study course instructing application of electronic computers to business clerical operations. Free information. BUSINESS ELECTRONICS, Programming Branch, Box 3330 Rincón Annex, San Francisco 19, Calif.

CLOSEOUT

Radio Test Kits. Signal Corps Test Equipment IE-35-A. In wooden carrying case. Orig cost \$414 ea. Our price \$29.50 ea. CONSTRUCTION & POWER MACHINERY, INC., 270-23rd St., Brooklyn 15, N.Y. Tel. SOUth 8-4900.

WANTED: Electronics men to qualify for Engineering Degrees by comprehensive examination. No courses. Excellent employment opportunities waiting. CRAWWELL INSTITUTE, RE-7, Adams, Mass.

TELEVISION Tuner Repairs. DAN'S TELEVISION LABORATORY, 606 Sunrise Highway, Babylon, N. Y.

PRINTING—250 Letterheads (5 1/2 x 8 1/4), 250 Envelopes. Both for only \$4.95 postpaid. DERBY PRESS, Box 7091, Derby, Vermont.

DIAGRAMS FOR REPAIRING RADIOS \$1.00. Television \$2.00. Give Make, Model. Diagram Service, Box 672-RE, Hartford 1, Conn.

TRANSISTORIZED F-M KIT \$9.95 less transistor. EKERADIO, 646 North Fair Oaks, Pasadena, Calif.

TUBES—TV, RADIO, TRANSMITTING, AND SPECIAL PURPOSE TYPES BOUGHT, SOLD AND EXCHANGED. Send details to R. E. Gensler W2LNI, 512 Broadway, N.Y. 12, N.Y.

RUBBER STAMPS, for every purpose, professional one day service. 25c per word. HAWTHORNE CO., Otsego, Mich.

ALL MAKES OF ELECTRICAL INSTRUMENTS AND TESTING equipment repaired. Hazleton Instrument Co., 128 Liberty Street, New York, N.Y.

"HYPNOTIZE—One word—One finger-snap!" (Details—3c.) HYPNOMASTER, 846-H5 Sunnyside, Chicago 40, Ill.

COMPLETE Television Sets \$11.95. JONES TV, 1115 Rambler, Portstown, Pa.

TRADE-IN TV sets. Ship anywhere. Dollar per inch (10"-\$10), (12"-\$12), (16"-\$16). Makes extra set or sends radio parts. Packing \$5 extra. JUSTIS BROS., Newport, Delaware.

RECORDERS, HI-FI, Tapes, Wholesale prices. Catalogue. KARSTAN, 215 East 88th St., New York 28, N.Y.

DIAL-A-MATIC adding machine. Adds (up to 99,999). Subtracts! \$2 Postpaid. M-LEES, Box 6792 (R), San Antonio, Texas.

WANTED: AN/APR 4, other, "APR." "TS." "197", ARC-1, ARC-3, ART-13, RC-348, etc. Microwave Equipment. Everything Surplus. Special tubes. Test Manuals. Lab Quality Equipment. Meters. Fast Action. Fair Treatment. Top Dollar! Littell, Fairhills Box 26, Jaxton 9, Ohio.

PROFESSIONAL Electronic Projects—Organis. Timers. Intercoms. Molstrurometers. Counters, etc. \$1 each. List Free. PARKS, 101 S.E. 57th, Portland 15, Oregon.

WANT A VERY LOW RESONANCE SPEAKER? Ask your dealer to demonstrate the RACON "hi-compliance", floating cone, foam-suspension loudspeaker, or write for literature and prices to RACON ELECTRIC CO., 1261 Broadway, New York 1, N. Y.

LONG Playing Records 20 to 50% Discount. Brand-New Factory Fresh Unplayed—All Labels. Send 20c for catalogue to RECORD SALES, 1110 Wimber, Houston 4, Tex.

LEARN WHILE ASLEEP! Details, complete instructions \$2. Satisfaction guaranteed. RESEARCH ASSOCIATION, Box 610-H, Omaha, Nebr.

QSLs Want 'em fast? Reasonably priced? Clearly printed? Ham's "Super-Speed Specials" has the answer. Samples 10c. ROBINSON W9AYL, 12611 Sacramento, Blue Island 1, Ill.

Patents. Copyrights. SANDERS, Registered Patent Attorney, 6420 Evans, Chicago 37, Ill.

BEFORE YOU SELL CALL REX!

WANTED—SURPLUS MILITARY AND COMMERCIAL AIRCRAFT ELECTRONICS: RC-788, 1-152, ARC-7, ARC-1, ARC-3, BC-221, RTA1B, ART-13, DY-21, APN-9, transmitters, receivers, test equipment, etc.!

WANTED—ELECTRONIC TUBES: Broadcast, transmitting, receiving, Magnetrons, Klystrons, miniature, sub-miniature, ruggedized, etc.!

TOP PRICES PAID! FOR FATTEST CHECKS—SELL TO REX! Write or phone description for immediate action. R. L. SANETT, W6RIN, 1524 S. Edris Drive, Los Angeles 35, Calif. Phones: REpublic 5-0215, CHeatview 1-3856.

AUTOMOBILE RADIOS, WHOLESALE PRICES. SELCO PRODUCTS, Department RE-1256, Danvers, Mass.

WANTED: ART 13, ARC 3, ARC 1, RC 788, and other Military Surplus. JAMES S. SPIVEY, INC., 4908 Hampden Lane, Bethesda, Md.

MONEY made servicing television sets when using special Build-It-Yourself Trouble shooting tester from old television set. \$2. STERLING, 129 West Long Ave., New Castle, Pa.

TAPE RECORDED CODE COURSES, Novice—4 hours instruction, \$11. The very best. Details—TAPECODE, Box 31-D, Langhorne, Pa.

TRANSISTOR KITS. Free Information. TRANSIT ELECTRONICS, Box 15-EE, Alden Manor, N. Y.

DIAGRAMS! Repair Information! Radios—Amplifiers—recorders \$1. Televisions \$1.50. Give make, model, chassis—Norton-Phillips & Ambergrey tubes in stock! TV MITLE, Box 101EA, Hicksville, N.Y.

A SUPER MAGNET — AT A SUPER SAVING!

LIFTS MORE THAN 20 TIMES ITS OWN WEIGHT.

Now for a limited time only—you can buy this Little Giant magnet, the most powerful ever made, at a sensational bargain! The low, low price of \$1.50 is less than 50% of what you'd usually pay for this type magnet. Experimenters and hobbyists will find hundreds of uses for this powerful 4 oz. Alnico permanent magnet. CAN LIFT

5 LBS. EASILY. Through a special purchase we are able to offer these Super magnets at this amazing low price. A limited quantity only. First come first served. Order several today. Low price includes keeper. Measures 1 3/4 x 1 1/2".

Item No. 86
Special Bargain Price
(Shp. Chgs. 10c)

\$1.50

(Regularly priced at \$3.50)



6-VOLT BATTERY, SOLDERING IRON AND WELDER

U.S. Army release. New. Guaranteed. Can be used to solder or weld when connected to any 6v storage battery. The high intensity arc created between the metal to be soldered and the carbon electrode (carbons supplied free with iron) can be used to heat tin or aluminum solder, light brazing and spot welding, melting metals, etc. Includes 2 carbons, 3 heavy duty spring clips, 2 pieces 5 ft. heavy duty wire cable. (Battery not included.) Ideal for use where current is not available. Ship. wt. 4 lbs.

ITEM NO. 126
UNUSUAL BUY **\$1.95**

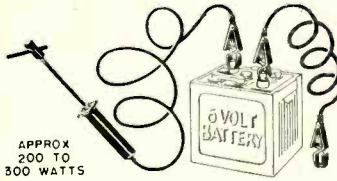

APPROX
200 TO
300 WATTS

(P. P. & Hdq. Chgs. 50c)

AMAZING BLACK LIGHT



250-watt ultra-violet light source. Makes fluorescent articles glow in the dark. Fits any lamp socket. For experimenting, entertaining, unusual lighting effects.

ITEM NO. 87
Ship. wt. 2 lbs.

\$2.45

(P. P. & Hdq. Chgs. 35c)

WATTHOUR METER

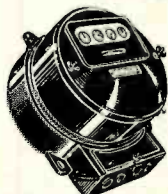

Leading makes—reconditioned. Ideal for trailer parks. 100-110 volts, 60 cycles. 2-wire A.C. 5 amp. Heavy metal case 8 1/2" x 6 1/4" x 5". Easy to install. Ship. wt. 14 lbs.

ITEM NO. 33
NOW ONLY **\$4.50**
(P. P. & Hdq. Chgs. \$1.25)

250 POWER TELESCOPE LENS KIT

Make your own high powered 6 ft. telescope Kit contains 2" diam., 75" focal length, ground and polished objective lens and necessary eye pieces. Magnifies 50x to 250x. Full instructions.

ITEM NO. 123
(Shp. Chgs. 10c) **\$2.95**



HUDSON SPECIALTIES CO.
25 West Broadway, Dept. RE 12-56
New York 7, N. Y.

I am enclosing full remittance for items circled below. (be sure to include shipping charges.)

OR, my deposit of \$..... Ship balance C.O.D. MINIMUM C.O.D. ORDER \$5.00.

C.O.D. ORDERS ACCEPTED ONLY WITH 20% DEPOSIT. INCLUDE SHIPPING CHARGES.

86 87 33 126 123

Name Please Print Clearly

Address

City Zone State

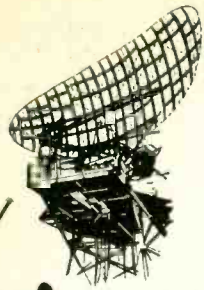

FIELD TECHNICIANS

Broaden the scope of your career with Bendix Radio!

Get these BIG ADVANTAGES!

- Professional status
- The prestige of representing the leader in its field.
- Top salaries
- Liberal field allowances

If you have 5 or more years of electronics experience, you benefit many ways as a Bendix Radio Field Engineer. You will receive full pay while you go to our company-sponsored school in Baltimore. Then, you will be given a key assignment in the United States or overseas with responsibility of maintaining search and surveillance radar equipment made by Bendix Radio.

Write, call or wire EMPLOYMENT SUPERVISOR Dept. V

Bendix Radio

DIVISION OF BENDIX AVIATION CORP
Towson 4, Maryland
(Phone Valley 3-2200)



TAPE-PLAYING TIME CHART

A new chart indicates playing time for tape of standard lengths on reels of various sizes. Data are for standard 1½-mil tape except where 1-mil or ½-mil thickness is indicated.

The first four columns, for speeds of 1 7/8 to 15 ips, for single-track tapes; the last two columns (3¼ and 7½ ips) for dual-track recording and recorded tapes.

ORRadio Industries, Inc., Shamrock Circle, Opelika, Ala.

PICTURE-TUBE REPLACEMENT GUIDE

Television Picture-Tube Replacement Guide. ETR-702B, lists 223 aluminized and nonaluminized tube replacements in classifications by size, base, bulb structure, external coating, anode contact, focus method, deflection angle, overall length, bulb diameter, neck length, anode KV and type of ion-trap magnet. The chart also furnishes characteristics of color picture tubes and metal-to-glass replacement information wherever possible.

General Electric Tube Dept., Schenectady 5, N. Y.

ELECTRONICS CATALOG

Over 27,000 items are presented in a new 356-page catalog. No. 160 covers the latest high-fidelity components, television chassis, boosters, rotators and uhf converters, table model and portable phonographs, professional and home recording equipment, public address amplifiers and complete systems, amateur receivers, transmitters and other gear, industrial vhf radio and telephone equipment, as well as a wide selection of supplies, books, manuals, diagrams, tools, hardware and other radio, TV and industrial electronics items.

Allied Radio Corp., 100 N. Western Ave., Chicago 80, Ill.

PARTS CATALOG

Electronic Parts Catalog No. 65 supplies complete descriptions of industrial electronics equipment and parts, high-fidelity components and systems and radio, TV and amateur gear in its 308 pages. Also offered for the convenience of industrial buyers and engineers are special quantity prices.

Newark Electric Co., 223 W. Madison St., Chicago 6, Ill. END

CORRECTION

Tony Karp of Richmond Hill, N. Y. points out that the 2N94-A transistor in the flea-power transmitter (page 52 of the October issue) is an n-p-n type so the arrowhead on the emitter symbol must be reversed.

William C. Roach, of Norfolk, Mass., adds that the CK722 and 2N107, mentioned as possible low-cost substitutes for the 2N94-A, are p-n-p types requiring reversal of battery polarity.

Our thanks to both these alert readers for these corrections.

AUDEL'S TV TELLS HOW TO ANSWER RADIO T.V. QUESTIONS SERVICE LIBRARY

HERE IS LATE INFORMATION IN A HANDY FORM FOR TELEVISION AND RADIO REPAIRMEN, SERVICEMEN AND STUDENTS

AUDEL'S T.V. RADIO SERVICE LIBRARY—Highly Endorsed—Over 1500 Pages—1048 Illustrations & Diagrams. 1001 Important Facts & Figures on Modern Television, Radio, Electronic Devices at your finger ends.

INCLUDES TRANSISTORS & Transistor Circuits, Record Changers, Rectifiers, P.A. Systems, Tape Recorders, Phonograph Pick-ups, F.M., Auto Radio, Radio Compass, Short Wave, Radar, etc.

ASK TO SEE IT! IT WILL PAY TO KNOW—The Basic Principles—Construction—Installation—Operation—Repairs—Trouble Shooting. Shows How to get Sharp, Clear T.V. Pictures. Install Aerials—How to Test. Explains Color Systems, Methods of Conversion, Terms, etc. Includes Ultra High Frequency—Valuable for Quick Ready Reference and Home Study.



\$6 COMPLETE 2 VOLUMES

Get this Information for Yourself.

7 DAY TEST—PAY ONLY \$1 A Month

MAIL ORDER

AUDEL, Publishers, 49 W. 23 St., N.Y. 10, N.Y. Mail AUDEL'S T.V. RADIO SERVICE LIBRARY (2 Volumes) \$6 on 7 days free trial. If O. K. I will remit \$1 in 7 days and \$1 monthly until \$6 is paid. Otherwise I will return them.

Name _____
Address _____
Occupation _____
Employed by _____ RE

DeRO TV AIDS PROFITS

MORE FOR YOUR MONEY

New and Hot!

DeRO-Juvenator

model RPS-2
For Use In PARALLEL or SERIES FILAMENT CIRCUITS



Small, Compact One piece construction \$2.00 LIST

Look for This!

Dynamic COUNTER DISPLAY

DeRO quality parts are packaged for easy identification. Look for the DeRO trademark on all television accessories.



Where Quality Counts—Buy DeRO!

AT ALL LEADING DISTRIBUTORS!

JOBBER—DEALERS! WRITE FOR DETAILS

DeRO ELECTRONICS
134 NASSAU ROAD
ROOSEVELT • LONG ISLAND • N. Y.

Books



RCA TRANSMITTING TUBES (Technical Manual TT-4). Commercial Engineering, RCA, Harrison, N. J. 5 3/8 x 8 3/8 inches, 256 pages. \$1.

This is the first postwar edition of a manual that could be found in almost every prewar ham shack and radio engineer's bookshelf. As we recall, the earlier editions listed only those transmitting tubes with plate input ratings up to about 1,000 watts. The latest edition lists 112 types of power tubes with plate input ratings up to 4 kw and 13 rectifiers suitable for use with them.

The first 87 pages are devoted to power-tube fundamentals, construction and materials, applications, circuit-design considerations and rectifier circuitry and design. Included is step-by-step design data on af and rf power amplifiers, audio modulators, frequency multipliers and oscillators. Simple calculations are given for determining operating conditions for class-C radiotelegraph and plate-modulated radiotelephone amplifiers, multipliers and class-AB and -B modulators. There are 61 drawings and charts in this section of the manual.

The book concludes with 16 practical circuits including a vfo for the 80-meter amateur band, crystal oscillators for fundamental and harmonic output, modulators with 120 and 590 watts output, transmitters for 2- and 10-meter fixed or mobile operation and circuits of simple dielectric and induction heaters.

MAGNETIC AMPLIFIERS, by H. F. Storm. John Wiley & Son, Inc., New York, N. Y. 6 x 9 inches, 545 Pages. \$13.50.

This, one of a series of books written by G-E authors, is intended for senior engineering students. It involves considerable math.

The magnetic amplifier is not a recent development. It was utilized by Dr. Alexanderson back in 1916 to establish radiotelephone communication with Europe. It was also used in the "colorama," a tuning indication for radio receivers, about 25 years ago. It is used at the Radio City Music Hall (New York) to control lighting and has many other practical applications listed in the book.

This text begins with a thorough description of magnetic theory to put the reader on solid ground. It continues with simpler saturable reactors with various loads, then with feedback. The amplistat receives considerable attention under various conditions. Cores, coils and rectifiers are covered in a separate chapter.—IQ END

DECEMBER, 1956

THE PROFIT TRIO!

MAKES VISUAL ALIGNING
QUICK, SIMPLE, PROFITABLE

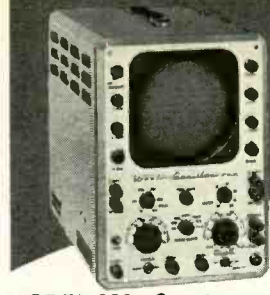

MODEL 983—Oscilloscope



MODEL 984—Sweep Generator



MODEL 985—Calibrator

Here are the three instruments that enable you to align by the WESTON *Simplified* method . . . the method that cuts alignment time in half, and thus makes this job highly profitable for servicemen. Ask your distributor for all the facts or write for the Test Equipment bulletin — R 36-A. WESTON Electrical Instrument Corporation, 614 Frelinghuysen Avenue, Newark 5, New Jersey. *A subsidiary of Daystrom, Inc.*

WESTON
TEST EQUIPMENT

The Quality Line

CHRISTMAS SEALS

Guardians Of Your Health

. . . for fifty years!

FIDELITONE
DIAMOND
PHONOGRAPH NEEDLES

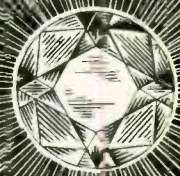

QUALITY and DEPENDABILITY BACKED

by 27 YEARS of DESIGN LEADERSHIP.

PERMO, INC.

Chicago 26

1956 ANNUAL INDEX

Vol XXVII

(Key to abbreviations on pg 161)

RADIO-ELECTRONICS

A							
Abbreviations							
and Symbols (Kimball)	Nov 81;	Dec 109					
Electronic Terms (R-E)	Jan 138, Mar-108,	July 86					
Correspondence on	July 12						
Plus, Much Fuss About (Prensky)	Apr 102						
Agc in TV Alignment (Baum and Bowden)	Dec 92						
Transistor (Corres)	Jan 18, Aug 10, Sept 18, Nov 18						
Aligning Broadcast Receivers (Dalley)	June 80						
Amplifiers—See Audio; Television; etc.							
Antenna(s)							
Auto, tool (TTO)	Apr 130						
End Effect (QB)	Oct 128						
Elements (TTO)	Aug 109						
Electronic Compass Orients* (Turner)	Jan 118						
Feedthrough, Holeless (TTO)	Feb 111						
Impedance-Matching Stubs (QB)	Apr 126						
Installation Precaution (TTO)	Apr 128						
Portable Loop Homing (Crisses and Gnessin)	Dec 88						
Vhf, Novel* (REC)	May 137						
TV							
Community (RM)	May 6						
Crosley (Tech)	Aug 99						
-FM Switch (Herlocher)	May 49						
Installing (TTO)	Mar 147						
Interference, Co- and Adjacent-Channel (Noll and Mandl)	Oct 61						
Rhombic (QB)	Aug 100						
Uhf							
Installation Kink (TTO)	Aug 108						
Simple (TTO)	June 109						
Underground Master (Miller)	Oct 98						
Vertical (QB)	Dec 133						
Are Electrons Fast or Slow (Manly)	Aug 43						
AUDIO							
Accessories, Cabinart†	May 80						
Amplifier(s)							
115-230-Volt (QB)	July 108						
and Audio Tester* (Davidson)	Dec 60						
Bogen DB15G†	May 61						
British Quad†	May 61						
Craftsman C-500†	May 59						
Crestwood Speaker†	June 34						
Direct-Coupled (REC)	Feb 120						
Dynakit†	Aug 47						
Electro-Voice Circlotron†	May 62						
Correspondence on	July 14						
Feedback, Stabilizing (Crowhurst)	Dec 34						
Fisher 50-A, 70-A†	May 61						
Golden Ear, Balancing the (Conradi)	Nov 56						
High-Fidelity Power (Marshall)	May 59						
High-Gain, Transistor* (Braunbeck)	June 30						
Laboratory Golden Ear* (Marshall)							
Part I—Build as unit or adapt to existing equipment	Aug 41						
Part II—Adding variable damping; construction and adjustment	Sept 56						
Long-Tailed Cascade Pair* (Hedge)	Oct 40						
Low-Distortion (Corres)	June 12						
McIntosh†	May 61						
National Unity-Coupled Horizont†	May 62						
Phono, Simple (QB)	Sept 127						
Pilot AA-90†	Jan 121						
Pilotone AA-904†	Jan 128						
Printed Circuit	Oct 36						
Stephens OLT†	May 62						
Tape Recorder, Improved* (Augsburger)	July 47						
Three-in-One* (Sharpe)	Mar 53						
Two-Channel	Oct 50						
Transistorized, for Interflex Tuner* (Grace)	Mar 59						
Ultra-Linear Operation†	May 60						
Upside-Down* (Augsburger)	Nov 54						
Variable Damping	Oct 45						
Williamson†	May 60						
Baffle, Building a (Hartley)	Feb 59						
Correspondence on	June 10						
Cable (QB)	Dec 134						
Cartridges							
Elac Miratwint	Sept. 6†						
Fentone B&O, P-12†	Apr 39						
Pickering Fluxvalve (Stanton)	May 57						
Recoton-Goldring†	Mar 62						
Shure WC10†	Sept 61						
Changers							
Adapter Failure (Tech)	May 130						
Convert 78 to 33 $\frac{1}{3}$ Rpm (TTO)	Dec 143						
Next	Apr 38						
Rumble filter for 45's (REC)	Jan 172						
Circuits, Developments in (Scott)	Feb 54						
Class B for Transistors* (Bohr)	May 55						
Control Unit							
Marantz Console†	July 50						
Power Supply (QB)	June 110						
Conversions Are Profitable* (Chernof)	Nov 60						
Crossover(s)							
Network, Van-Amp†	Feb 54						
Questions About (Crowhurst)							
Part I—Locating network, rolloff filters, filter and speaker terminations	July 44						
Part II—Rolloffs, network components, voice coil impedances, phase	Aug 44						
Destaticizers and Cleaners†	Mar 62						
Diode Detection, Better (REC)	Aug 103						
Enclosures							
Baffle Liners (QB)	Nov 134						
Baffle, Building a (Hartley)	Feb 59						
Correspondence on	June 10						
Karlson, Correction	Feb 104						
Filters							
Bandpass, Variable (REC)	June 113						
Phono Motor Click (QB)	May 136						
Rumble, for 45's (REC)	Jan 172						
FM Inoperative (Tech)	Feb 116						
Feedback							
Circuits†	Jan 64						
From Voice Coil (Crowhurst)	Oct 48						
For Golden Ears Only	Jan 127; Feb 57; Mar 61;						
Apr 38; June 34; July 50; Aug 47; Sept 61							
Harmonic-Distortion Meter, Heathkit HD-1†	Aug 48						
High Fidelity Grows Up (Leslie)	Dec 45						
Intercoms—See Intercoms							
Load Lines, More About (Crowhurst)	Apr 40						
Loudness Control (QB)	July 109						
Loudspeaker(s)							
Auto Rear-Seat, Adding a (TTO)	Apr 128						
Electrostatic (RM)	Aug 8						
Field Supply (QB)	Aug 100						
Frazier-May Symphony-Divat	July 51						
Goodman Axiom 80†	Aug 49						
Horn Type							
Correspondence on	Jan 14						
For Golden Ears* (Augsburger)	Apr 34						
Impedance Measurements* (Reed)	Oct 46						
Pro-Plane Prismatic †	Feb 58						
Repairs (TTO)	Mar 146						
Sound Bug (Ray)	Oct 34						
Substitute (TTO)	Aug 109						
Voight-Lowther (Corres)	Jan 14; Mar 10						
Microphones							
Fentone B&O	June 35						
Reslot	June 35						
Wireless, Transistorized* (McCready)	June 36						
Motion Pictures, Glorious New Sound for (Nadell)	Dec 42						
New Records Review	Jan 152; Feb 102; Mar 132;						
Apr 104; May 102; June 91; July 92; Aug 90; Sept 120; Oct 123; Nov 114; Dec 112							
Output							
Class B for Transistors* (Bohr)	May 55						
Meter, AF (REC)	Jan 173						
Stages, Balance With VTVM (Rodgers)	Oct 42						
Pickup(s)—Also see Cartridges, Tone Arms							
Loading Phono (Marshall)	Oct 37						
Preamplifier(s)							
Broadcast (QB)	Apr 125						
Hi-Fi, for Easy Listening* (Owens)	Sept 59						
Phono, Transistor†	Feb 55						
Record Players (TTO)	Aug 108						
Schools, Service the (Johnson)	May 94						
Servicing—See subjects; Servicing							
Signal Generator* (Greenlee)	Sept 48						
Sound Bug (Ray)	Oct 34						
Sound Effects							
Device (Pat)	Nov 141						
Echo Unit, Build This Simple* (Costigan)	Feb 52						
Novel (TTO)	July 117						
Sound Track, Optical (Tech)	June 105						
Speaker-Saver Circuit, Scott 265-A†	Feb 55						
Speech-Music Discriminator* (Predmore)	Sept 62						
Squelch for Hallicrafters S-81 (QB)	May 134						
Synthetic Music via Electronics (Heller)	Mar 56						
Tape(s)							
Background Noise Reduction in (McRoberts)	Oct 43						
Pre-recorded (New Records)	July 92						
Re-recording (Pat)	Oct 140						
Splicer, Gibson-Girl†	June 35						
Stereo							
Tape Comes of Age (Burstein)	Nov 57; Dec 134						
Tapes (New Records)	Feb 102						
Timing (TTO)	Nov 142						
Tape Recorder(s)							
Ampex Stereo System†	Feb 57						
Amplifier, Improved* (Augsburger)	July 47						
Concertone 20/20†	Mar 61						
Crestwood 404†	June 34						
Operation (Heller)	Apr 36						
Service (Burstein)							
Part I—Poor frequency response, insufficient erase	May 75						
Part II—Weak or no sound, distortion, hum, noise	June 32						
Tone Arm, Ortho-Sonic V/4†	May 82						
Tone Control (QB)	May 135						
Adding (QB)	Sept 127						
TV—See Television							
Test Equipment—See Test Equipment							
Tremolo Oscillator, Correction	Apr 114						
Tuner(s)							
Ac-Dc Set as (TTO)	June 108						
Browning L-500†	June 54						
Knight AM-FM-TV SX702†	May 79						
Pilot AM-FM AF-850†	Jan 127						
Scott 310 FM†	Apr 38						
Table Radios into Hi-Fi (Marshall)	Jan 134						
Turntables, Scott 710 Stroboscopic†	Jan 128						
Volume Control (QB)	May 135						
Switches (TTO)	Feb 132						
B							
Background Noise Reduction in Tape (McRoberts)							
Oct 42							
Battery							
Holder	Apr 60						
Tester (What's New)	Feb 43						
Blind							
Aiding the (Pat)	Jan 170						
PBX Operators (RM)	Oct 8						
Britain Takes on Commercial TV (Dresser)	Jan 68						
Build This—See also specific subjects; con- struction articles identified by "†"							
Simple Echo Units* (Costigan)	Feb 52						
Solar-Powered Radio* (Bohr)	Mar 34						
Transistorized Intercom With 0.6-Watt (Output* (Turner)	July 48						
Universal Experimental Chassis* (Freund)	Sept 79						
Wide-Band Crystal Oscillator* (Queen)	Nov 36						
Building a Baffle (Hartley)	Feb 59						
Correspondence on	June 10						
C							
Calibrating Ac Voltmeters* (Kaufman)							
Nov 40							

SAVE A DOLLAR



Leeds & Northrup Micromax Recorders

Strip type recorder used for controlling and recording wide variety of processes. Used originally for temp. range of 350-550° C. but may be changed for other applications. Operates on Wheatstone bridge principle using AC galvanometer movement. Original cost several times our low price. Removed from demilitarized equipment which in many cases was new. Sold as used but guaranteed, or money back if not satisfied. Ship. wt. approx. 165 lbs. \$179.50 Ea.

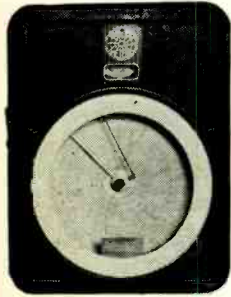

BAILEY METER RECORDERS

Used in application as above at same temperature range, etc. Operates on electronic principles using vacuum tubes. Used but guaranteed. Ship. wt. 165 lbs. \$65.00 Ea.



14 Amp. Battery Charger While Supply Lasts

Cost Govt. \$300 ea. Our purchase of large quantity allows this bargain. Charges 6, 12, or 24 V. batteries at 14 amp. rate max. Operates from 110 V. DC. Mfg. by Ward-Leonard. Size 12" w x 20" h x 10" d. Brand new in orig. packing. wt. approx. 80 lbs. They'll go fast at this low price, so order now. \$7.50

Brand New 12 V. Dynamo

DM-10 Input: 12-14 V. 3.4 A. Output: 172 V.—138 MA. An ideal dynamo to adapt to mobile uses on the new 12 V. cars. Don't pass up this buy even if your intended uses are not immediate. Size 6 3/4" L x 3 1/2" dia. 4" lead with 6 pin Jones plug. Ship. wt. 7 1/2 lbs. \$2.75

Freq. Crystals... Less Than 5c Ea.

Imagine crystals costing Govt. \$3.50 to \$12.50 ea. in this assortment. 100 brand new, various freq., plenty in hand. Practically all types of holders; all mounted; guaranteed to oscillate. Assortment of 100. Ship. wt. 4 lbs. \$4.95



Rectifier Special New \$1.95

Brand new GE copper-oxide dry disc rectifier designed to give output voltages to 60 V. DC @ 1 amp. Full wave bridge type. May be restacked for 6, 12 and 24 V. DC charging currents up to 3 amps. Size 8 1/2" long x 3 3/4" square radiation fins 24 cells. Ship. wt. 8 lbs. \$1.95

NEW Guaranteed Tubes

Removed from new radar & elect. equip. but never used.

FG-17 Thyatron	\$1.00 ea.
FG-32 Phanotron	\$2.00 ea.
2051	.65c ea.
533GT and G	.30c ea.
12A6	.30c ea.
7193	10 for \$1.00
934	10 for \$1.00
VR-105	.50c ea.
61G6/G	\$1.00 ea.

R-1/ARR-1 Receiver... \$2.95



Described in Radio TV News, Jan. 1949 for use as 220 Mc. converter. Essentially a two stage RF acorn tube superhet converter as it now stands. Also can be used for a preselector. Small enough for mobile; only 3 1/2" w x 3" h x 10" d. Rugged aluminum construction. Has four 954 acorn tubes. Filaments now operate on 12 or 24 V. by merely throwing switch in unit or can be easily modified for 6 V. operation. Dial is calibrated in range of 234-258 Mc. Operation can be changed for use from 50 to possibly 300 Mc. Cover not shown but included. Complete with conversion as written in above mag. Brand new demilitarized units. Ship. wt. 4 lbs. \$2.95

ARR-1 Antenna for above receiver and freqs. Ship. wt. 1 lb. New \$1.25
Coaxial antenna relay for use with above or other transmitter-receiver combinations. Ship. wt. 2 lbs. New \$1.25

Miniature Storage Batteries

BB-51. 6 V. Consisting of 3 lead acid cells delivering 6 V. for 2.75 hrs. thru a 300 ohm resistance. Pin type terminals. Size overall 4-3/16" x 1 1/4" x 1 5/16". Ship. wt. approx. 5 ozs. New, dry-charge \$1.75
BB-52. 36 V. Consisting of 18 lead acid cells delivering 36 V. for 3 hrs. thru a 1200 ohm resistance. Pin type terminals. Size overall 4 1/4" x 1 7/16" x 1 5/16". Ship. wt. approx. 5 ozs. New, dry-charge \$1.95
COMPLETE PACK BB-208 includes 3 of the BB-52 and one BB-51 miniature storage batteries above, all packed in vacuum sealed can. New, dry-charge. Ship. wt. 3 lbs. \$3.95

OAV-1 TEST SIGNAL GENERATOR. \$19.95

This signal generator was used to provide a test signal of constant frequency for operation and alignment of RF amplifier stages in the CG-46 ACQ type receivers. The generator covers the range between 150-250 megacycles. Amplitude modulated square wave output is obtained at frequencies of .1, 1, 10 and 100 kc. depending on the position of the freq. mod. pulse switch. 15 Mc. signal is also provided by a second osc. stage. Power is supplied by internal 115 V. 60 cycle AC supply connected to source by cord provided. Brand new with instruction book. Ship. wt. 62 lbs. \$19.95

SYNCHRO Motor and Generator Only \$9.95 Per Pair

By simply connecting like wires of each unit and applying 110 V. 60 cycle current to junction of two rotor wires you have an electrical equivalent of a flexible shaft without the usual friction, backlash, and error. Dream up your own applications such as remote reading weather vanes, remote control antenna rotation, liquid level indicators, etc. (Diameter size 5 1/4" x 3 1/2" dia.). Cost Navy many times our low price. Ship. wt. 12 lbs. per pair. Removed from equip. Guaranteed. Per pair \$9.95

110 V. 60 Cycle Units

Size Type	Approx. Weight (Lbs.)	Approx. Length (Inches)	Approx. Diameter (Inches)	Price Used	Price New (Cases may be slightly nicked)
SF	5	6.0-6.8	3.4-3.6	\$5.00	\$10.00
SG	5	6.0-6.8	3.4-3.6	5.00	10.00
SDG	5	6.0-6.8	3.4-3.6	5.00	10.00
SCT	5	6.0-6.8	3.4-3.6	5.00	10.00
6F	8	6.4-7.5	4.5	7.50	15.00
6G	8	6.4-7.5	4.5	7.50	15.00
6DG	8	6.4-7.5	4.5	7.50	15.00
6CT	8	6.4-7.5	4.5	7.50	15.00
7G	18	8.9-9.2	5.8	10.00	(None)
7DG	18	8.9-9.2	5.8	10.00	15.00

110 V. 400 Cycle Units

Size Type	Approx. Weight (Lbs.)	Approx. Length (Inches)	Approx. Diameter (Inches)	Price Used	Price New (Cases may be slightly nicked)
SF	5	6.0-6.8	3.4-3.6	\$3.50	\$7.50
SG	5	6.0-6.8	3.4-3.6	3.50	7.50
SDG	5	6.0-6.8	3.4-3.6	3.50	7.50

CT—Control Transformer; D—Differential Motor; DG—Differential Generator; F—Motor (Follower); G—Generator. Mfgd. by Bendix Ford Instrument Co., and General Electric. Specify.

New Torque Amplifier Only \$9.75 FOR USE WITH SYNCHROS SIZE 5, 6, 7

Provides torque amplification and ease in rotation of input shaft. Rotating power applied to input shaft is reproduced in any direction on the output shaft. Torque supplied entirely by a 1/30 HP 110 V. AC motor through gear and planetary drive hookup. Speed varies directly with rotation of input shaft with noticeable loss of accuracy. Motor requires capacitor of 85-120 mfd. for starting. Designed for use on gun control devices and cost the Govt. hundreds of dollars to mfg. In cast aluminum case. Size: 12" h. x 5 3/8" w. x 7 1/2" d. Wgt. 23 lbs.

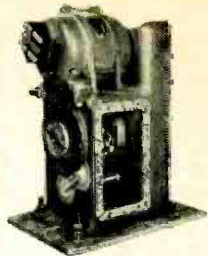

Packed in original wood box. Ship. wt. 45 lbs. \$9.95
Brand New \$9.75
Starting capacitor for above Torque Amplifier. New. \$1.00



RL-42-B Antenna Reel/Motor... \$2.50

Used originally for remote controlling of automatic trailing wire antenna. Motor is 1/8 hp. x 24 V. DC with oil-less sleeve bearings. The gear train, breaking and disconnect mechanism, reversible and variable speed motor makes this an ideal unit for conversion to coil winders, etc. Ship. wt. approx. 5 lbs. Used \$2.50 New \$3.95

Kerosene or Gasoline Heater Reduced to \$4.95

Brand new. Evans blue flame heater. Output approx. 50,000 BTU. Ideal for garage or shack where not confined. Size: 10" dia. x 12" high. Cost Govt. many times our low price. Shipped in original packing; wt. 47 lbs. \$4.95



Golf Car Motor... \$4.50

New 1 1/2 hr. battery-operated motor for building up your golf car or other use. Operates from 12 to 24 V. with speed to 6000 RPM. Measures 4 1/2" dia. x 9" long. 3/8" shaft. Wt. 11 1/2 lbs. Ship. wt. 13 lbs. \$4.50

ER-25-6, 6 V. 25 AH Storage Battery

Plastic case size 7 1/2" x 2-9/16" x 6 3/4" h. Shipped dry charged. Filled with 1,265 sp. g. sulphuric acid. Ship. wt. 8 lbs. New \$3.95



Oil Capacitors

4 mfd 600 V. S.	\$1.00
2 x 1 mfd. 600 V. CD	\$1.00
1 mfd. 1500 V. GE	\$1.00
1 mfd. 3500 V. G.	\$1.00
2 x 1 mfd. 4500 V. GE	\$1.00
2 mfd. 5000 V. I.	\$1.00
3 x 2 mfd. 4000 V.	\$2.00
1 mfd. 4000 V. CD.	\$2.00
12 mfd. 15000 V. GE	\$3.75

All leading popular brands. All new; not shopworn. Guaranteed.

Tripl Relay

Instantaneous class 9055 Type N. Mfr. by Square D Co. 600 V. max. Three ranges available—.067—.15 amp.; 23-47 amp.; and 56-117 amp. State choice. Ship. wt. 4 lbs. Brand new \$1.95



M-1 ODOGRAPH... \$179.50

An instrument used for vehicular mapping of terrain over which it is driven. Compass information is passed on thru a photo electric circuit to the plotting unit which combines this information with the speedometer drive for control of pencil across the map paper, giving a map with possible errors of less than 1%. Will do survey work in hours that normally requires weeks. These instruments are new and the current mfgd. price is over \$3,000. They are versatile in that parts can be adapted to other uses such as the compass unit to auto pilot boat control, etc. Ship. wt. 26 lbs.

U.S. Corps of Engineers rebuilt units. \$179.50 complete
Brand new units. \$279.50 complete

Test Set EE-1. New—\$19.50

A test set for aircraft containing AC & DC volt. ohms, meter, tachometer, pressure gauge & test gauge cord & tools. In aluminum suitcase type case that opens for mounting sloping 2 sec. panel. Ideal for your test bench applications. Cost hundreds of dollars but yours in original evacuated shipping container. Ship. wt. 27.0 lbs. \$19.50

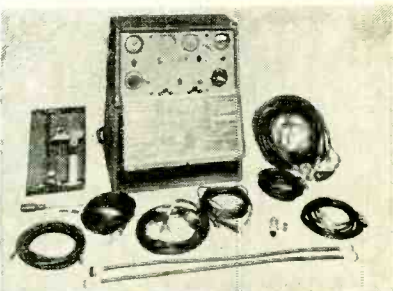

ESSE RADIO CO. 42 WEST SOUTH ST. INDIANAPOLIS 25, IND.

REMIT SHIPPING CHARGE AND INSTRUCTIONS WITH ALL ORDERS. OTHERWISE ORDER WILL BE SHIPPED EXPRESS COLLECT. ALL ITEMS GUARANTEED TO YOUR SATISFACTION OR MONEY REFUNDED IF RETURNED PREPAID WITHIN 10 DAYS OF RECEIPT

Dealing With (Margolis) Apr 56
 Dry Cells Can Be Reactivated (Hallows) Dec 49
 Duplex Signal Tuning (TTO) Sept 142
 Dx—See Television

E

Echo Unit, Build This Simple* (Costigan) Feb 52

EDITORIALS (H. Gernsback)
 Airplane Collision Prevention Sept 33
 Electronics in Space Flight June 29
 Electronics vs Human Judgment Oct 33
 Elements of Teleducation May 33
 Fifty Years of the Vacuum Tube Dec 33
 Future of Color TV Jan 35
 Minitelivision Aug 29
 Nikola Tesla's 100th Birthday July 29
 Space Electronics Feb 33
 National TV Servicemen's Week Mar 33
 Radio Astronomy Progress Apr 33
 Technician's Age Nov 33
 Electric Toy, Animated (Pat) Nov 140
 Electromechanical Pulse Producer (Shulman) July 85

ELECTRONIC—See also Electronic Alarms
 Brain Scores Fencing Hits (Davey) Aug 50
 Compass Orients TV Antennas* (Turner) Jan 118
 Counter Tube (Davies) Mar 104
 Muscle Trainer Aids Arthritis (Haas) Dec 53
 Scope Probe* (Rhodes) Nov 34
 Sterilization (Briggs) July 82
 Switch (REC) Nov 126
 Trailmaker (RM) Nov 14
 Voltage Regulation* (Hedge) Apr 88

ELECTRONICS—See also Electronic Alarms
 Bell System (QB) July 110
 Mid-Air Collision (RM) Nov 8
 Photoelectric (QB) Apr 125
 Pressure (Pat) May 126
 Radiation (REC) July 112
 Atomic Clock (RM) Dec 12
 Binary Device, Gas-Tube (Pat) Aug 105
 Blinker, Novelty (TTO) Oct 145
 Computers and Data Processors
 Air Defense (RM) Sept 6
 Data-Vision (RM) Feb 8
 End-of-Record Detector (Pat) Sept 141
 Industrial (RM) Sept 6
 Magnetic Recording System (Pat) Mar 112
 Signal Corps (RM) Oct 8
 Control Device (Pat) Sept 138
 Control Unit for Ventilating Fans* (McCready) May 86

Counter
 Crystal (Pat) July 114
 Scintillation* (Bray) Feb 34
 Part I—Construction
 Part II—Probe construction, assembly; adjusting, operating
 Single-Core Binary (Pat) Mar 97
 Tube, Electronic (Davies) Apr 117
 Delay Device (Pat) Oct 104
 Dry Cells Can Be Reactivated (Hallows) Dec 49
 Echo Sounding (Pat) Aug 107
 Electroluminescent Lamp (Pat) Sept 140
 Electrotimer, Simple Cyclic* (Parks) Feb 38
 Electrons—Fast or Slow? (Manly) Aug 43
 Image Converter (RM) Feb 6
 In the Air Force (Lane) June 58

Light
 Amplifiers (RM) Mar 8; Dec 8
 Computer, Photoelectric* (Satter) Sept 108
 Magnetostrictive Generator (Pat) July 115
 Metronome
 Simple (REC) Mar 136
 Stable, at Small Cost* (Jaski) Nov 63
 Negative-Resistance Circuit (Pat) July 115
 Pulse Producer, Electromechanical (Shulman) July 85

Radiation
 Alarm (REC) July 112
 Detector (Pat) Sept 140
 Geiger Counter
 Improved Suppy Powers* (Knight) Sept 106
 Sylvania Prospectort Transistor-Operated* (Knight) Aug 70
 Meter, Civil Defense* (Kaufman) Apr 59
 Radio-Frequency Lamp (Peek) June 73
 "Stars" (RM) May 8; Aug 8
 Telescope (RM) May 8; Aug 8
 Reactance-Tube Modulation (Pat) June 103
 Relay Moe Plays Tick-Tack-Toe (Berkeley) Dec 50
 Scintillation Counter—See counter

Solar
 Cell for Satellites Nov 94
 Flare Indicator* (Warshaw) Aug 51
 Sonar in One Hour (Boyden) Dec 55
 Sound-Activated Controller* (Sandretto) Mar 91
 Superconductivity (Corres) Apr 12
 Superconductor Oscillator (Pat) July 116
 Synthetic Music (Heller) Mar 56
 Correspondence on May 12
 Telescope Booster (RM) Nov 10
 Thermistor Thermometer, Versatile* (Squires) Apr 75
 Thermostat, Wireless (RM) Feb 6
 Thyatron Discharge Circuit (Pat) July 114
 Transistors—See Transistors
 Trigger Circuits, Junction Transistor (Schenkerman) Aug 37
 Underload-Overload Indicator (Pat) Aug 105
 Underwater Transducer (Pat) Dec 142
 Voltage Regulation, Electronic* (Hedge) Apr 88

Watchmaster, Servicing the (Darr) May 90
 Zero
 Beat Indicator (Pat) Oct 142
 Setting, Automatic (Pat) Oct 141

Employment
 Electronics in the Air Force (Lane) Aug 43
 Patent Examiners (Corres) Apr 18

F

Fencing, Electronic Brain Scores Hits (Davey) Aug 50
 Fiction—Cordless Radio Iron (Fips) (Rhodes) Apr 61
 Feedback From Voice Coil (Crowhurst) May 48
 50 Years of Home Radio (Gernsback) Oct 48
 Fluxvalve Pickup (Stanton) Mar 42
 FM
 Front End, for 10.7-mc If (REC) Aug 102
 Multiplexing (RM) Mar 8
 Information Theory Oct 101
 Radiation Control (RM) Feb 8
 Receiver, 3-tube* (Graham) Oct 56
 Tuning
 Aid (REC) Nov 127
 Indicator (QB) Feb 124; Nov 135; (REC) Dec 130
 Meter (REC) Oct 137
 -TV Antenna Switch (Herlocker) May 49
 Foldover, Intermittent (Thomas) Jan 75

G

Glorious New Sound for Motion Pictures (Nadel) Dec 42
 Guided-Tour Innovation (RM) Feb 6

H

Headphone(s)
 Adapter, TV (QB) May 135
 Low-Impedance (QB) Feb 127
 Low-Z for TV (TTO) Jan 181
 Hearing Aid (What's New) Feb 43; Aug 54; Oct 51
 Heater-Cathode Stress in Full-Wave Doubler (Chernish) Sept 40
 High Fidelity—See also Audio
 Grows Up (Leslie) Dec 45
 Power Amplifiers (Marshall) May 59
 Preamp for Easy Listening* (Owens) Sept 59
 Horn Type Speaker System for Golden Ears* (Augsburger) Apr 34

I

Image Converter (RM) Feb 6
 Improved Tape-Recorder Amplifier* (Augsburger) July 47
 Improving
 Low-Priced TV Sets (Lundy) Apr 58
 Sensitivity in Ac-Dc Radios (Garrett) Nov 110
 Television Audio (Crowhurst) Jan 64

Inductors
 Not All Are Coiled (Manly) Feb 77
 Unmarked (QB) June 112

Industrial TV—See Television

Inexpensive Capacitor Checker* (Kramer) May 40
 Inexpensive Phone Patch* (Frye) July 71
 Information Theory (Penfield) Apr 96
 Intercarrier Buzz, Servicing (McRoberts) June 42

Intercoms
 Adapter for (REC) Sept 134
 Five-Station Set (QB) Nov 134
 Home System, Complete* (Miller) Dec 38
 Pagers, Transistorized (RM) June 8
 Sylvania 1102† Transistorized, With 0.6-Watt Output* (Turner) Aug 33

Wireless, Webster Electric RFI† Interference
 Broadcast (QB) Apr 125
 Co- and Adjacent-Channel, Reducing (Noll and Mandl) Oct 61
 Intercarrier Buzz, Servicing (McRoberts) June 42
 Traps in Color TV Receivers (Mandl) Apr 52
 TV (Tech) Jan 178; June 105
 vs Signal Strength (Stratman) Apr 51

Wavetrap
 Double-Tuned for Broadcast Interference (QB) Apr 125
 Multiple (REC) Jan 171
 Intermittent Foldover (Thomas) Jan 75
 Intermittent Set Tester* (Dewar) Mar 64

Intermittents
 Surge Supply for* (Greenlee) Dec 58
 Tracking Down (Middleton) Dec 104
 Intermodulation Suppression (Pat) Dec 141
 It's a Matter of Psychology (Slaughter) Jan 55

J

Junction-Transistor Trigger Circuit (Schenkerman) Aug 32

K

Kinescope
 Color (Pat) Jan 169
 Three-Gun (Pat) Jan 169

L

Laboratory Golden Ear—See Audio, Amplifiers
 Licensing
 Atlanta Asks Powers (Tech News) Feb 107
 Cincinnati (Tech News) Jan 149

Licensing
 Columbus, No License in (Tech News) Mar 122
 Correspondence on Mar 16; May 14; June 10; July 12; Aug 14; Sept 18; Oct 22
 Detroit, in (Tech News) Apr 107; June 102
 Good or Bad? (Wheaton) Jan 72
 Houston Wants (Tech News) July 98
 San Jose Asks (Tech News) Oct 121
 Self-Licensing Plan (Tech News) Apr 107; May 106
 Light Amplifiers (RM) Mar 8
 Load Lines, More About (Crowhurst) Apr 40
 Loading Phono Pickups (Marshall) Oct 37
 Long-Tailed Cascade Pair* (Hedge) Oct 40
 Loudspeaker Impedance Measurements* (Reed) Oct 46

M

Magnetic
 Recording System (Pat) Mar 112
 Scale of Two (Pat) Feb 128
 Magnetostrictive Generator (Pat) July 115
 Making Photoetched Circuits in Your Workshop (Dorf)
 Part II—Sensitizing laminate; exposing panel; developing image; etching Jan 139
 Merchandising Idea (TTO) Nov 144
 Meters—See Test Equipment

Metronome
 Simple (REC) Mar 136
 Stable, at Small Cost* (Jaski) Nov 63

Microphones—See Audio

Model Control—See also Remote Controls
 Miniature Receiver for* (Turner) Apr 84
 Transmitter, 27,255 mc (QB) July 108
 Modifying Circuitry (Corres) Feb 14

Modular
 Scope (What's New) June 76
 TV Receiver
 Emerson 120306 Schematic June 46
 Now—(Shunaman) June 46

Monitoring
 By Feedback Techniques (RM) Apr 8
 Squelch for Hallicrafters S-81 (QB) May 134
 More About Load Lines (Crowhurst) Apr 40
 Motor Control, One Turn (REC) Oct 137
 Much Fuss About Plus (Premsky) Apr 102
 Correspondence on Dec 21
 Multimeter Transistor Checker* (Premsky) Aug 68
 Multiplex Weather Reports (RM) Apr 6
 Multiplexing, FM (RM) Mar 8

N

1956—Television's Year of Decision (Lachenbruch) Jan 45
 Neutrode—New Vhf-Uhf TV Tuner (Lucas) July 30

New
 Color Sets Simplify Servicing Oct 95
 Easy-to-Read Vtvm's (Scott) Apr 44
 "Rainbow" Tuner (Lucas) Jan 48
 Resonant-Frequency Nomo Permits Greater Accuracy (Sodaro) Dec 78
 TV Tube Testers (Scott) Mar 81

Noise-Immunity Circuits; Rapid Service Techniques (McRoberts) Dec 107
 Not All Inductors Are Coiled (Manly) Feb 77

O

Oscillators—See Test Equipment, etc.

P

Phase-Shift Chart (Manly) Sept 100
 Phase Shifter (Pat) Apr 115
 Phone Patch, Inexpensive* (Frye) July 71

Photoelectric
 Alarm (QB) Apr 125
 Light Computer* (Satter) Sept 108
 Correspondence on Nov 18

Photoetched Circuits in Your Workshop, Making (Dorf)
 Part II—Sensitizing laminate; exposing plate; developing image; etching Jan 139
 Photoflash Slave Unit (QB) Feb 126
 Photographic Flashtube (Pat) June 103
 Portable Loop Homing Antenna (Crisses and Gnessin) Dec 88
 Portable Scintillation Counter* (Bray)
 Part I—Construction Feb 34
 Part II—Probe construction, assembly; adjusting, operating Mar 97

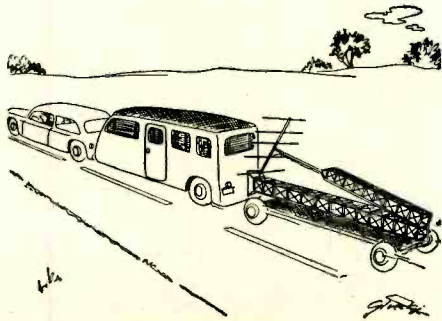

NEW MASTER VOLT OHMYST®

*Accuracy of
±3% full scale
on both AC and DC*



RCA-WV-87B—offers many time-saving work-simplifying features for laboratory, production, servicing—can help improve the quality of your work!

The WV-87B is housed in a durable metal case for general use around the service shop or the lab or for shelf- or rack-mounting on the production line. The unusually large meter face, clearly calibrated scales, and VoltOhmyst circuit permit extraordinary ease and speed in taking highly accurate readings. Helps you work better, faster, more efficiently. You can be positive of the measurements you take when you use the RCA Master VoltOhmyst.

RCA WV-87B Master VoltOhmyst—newest addition to the world-famous line of RCA superior-quality Test Instruments—is available through your RCA DISTRIBUTOR. Price \$137.50†. See him now for details and literature or write RCA, Commercial Engineering, Section L39W, Harrison, N. J.

Check these outstanding features:

- wide-vision open-face extra-large (7½") meter scale
- mirror-strip on scale to eliminate needle-to-scale parallax
- two-color, separate scales for speedy peak-to-peak and rms voltage readings
- work-simplifying single probe with built-in switch for all Ohms and DC/AC Voltage measurements
- high stability circuit free from effects of line voltage variations
- meter tracking error only ±1% or less
- accuracy of ±3% full scale on all AC and DC ranges
- DC current readings as low as 10 μa.

ELECTRICAL SPECIFICATIONS			
Operation	Ranges	Input R, C	Freq. Response
DC Volts	0 to 1500 (7 ranges) Low Scale, 0 to 1.5	*11 meg., 2 μμf	
AC Volts (RMS, sine waves)	0 to 1500 (7 ranges) Low Scale, 0 to 1.5	0.83 to 1.5 meg. 75 μμf to 85 μμf	30 cps to 3 Mc** (for source impedance of 100 ohms)
AC Volts (Peak-to-Peak values, sine or complex wave forms)	0 to 4200 (7 ranges) Low Scale, 0 to 4		
Direct-Current	0 to 15 a. (9 ranges) Low Scale, 0 to 500 μa		
Ohms	0 to 1000 megohms (7 ranges)		
MECHANICAL SPECIFICATIONS			
Height: 10"; Width: 13½"; Depth: 7"; Weight: 8 lbs.			

*1100 meg. with WG-289 Probe and WG-206 Multiplier Resistor.
**Crystal-Diode Probe WG-301A available to extend range to 50 Kc to 250 Mc within ±10%.
†User price (optional) Complete with WG-299C DC/AC-Ohms Probe, Low-Capacitance Flexible Cable, Current Leads, Ground Lead, Instructions.



Radio Corporation of America
Components Division
Camden, N. J.

Emerson 611 Apr 119; 614D Aug 98; 1106D (Clinic) June 45; 120166-D May 129; 120196 Aug 98

Garod Tele-Zoom Jan 118
G-E 810 (Clinic) Sept 43; 814 Apr 120; 825 Jan 178; 21T1 Sept 131; 21T3 (Clinic) Oct 64

Hickok 539A Tube Tester Mar 143
Magnavox 350 Oct 132; CT 358 Sept 130
Magnavox-Collaro 45-rpm May 130
Majestic Series 110 Aug 98; 7P420 May 127
Monitor M3070 Feb 114
Motorola Feb 113, Apr 120, Aug 98; 21" Feb 118; 71M Jan 178; TS 88 Jan 47; TS 118B June 107; TS 292 June 106; July 105; TS 410 (Clinic) Oct 64; 21T15 Dec 136

Philco 938K July 107; 22B410 Feb 113; 46-1201 July 106; 48-1000 Sept 130, Oct 135; 50-T1600 (Clinic) June 45; 50-T1630 Apr 119; 51-1730 June 107; C1908 May 127; R191, D191 Jan 71

Pure Oil 518 Sept 131
RCA CTC4 Mar 143; KC83 (Clinic) Nov 29; KCS47A Feb 113; KCS77 Sept 131; KCS83 Feb 118, (Clinic) Sept 42; KCS84 June 105; KCS 96, 97 July 105; KRK-7 (Clinic) May 54; T-120, T-121 Mar 145; 9T57 Mar 143; 17T211 Apr 119; 21-CT-66U, 662U May 129; 21-D-327 (Clinic) Aug 84; Split-Sound May 129

Regency RC-600 Converter Feb 114; TR-1 July 107
Sentinel 443 (Clinic) Sept 43; 456 (Clinic) Aug 84
Setchell-Carlson 151 Nov 136
Spartan 22312 Sept 130
Stromberg series 16 Mar 144
Stromberg-Carlson 624 Mar 52; 621CDM (Clinic) Dec 102

Stewart Warner 9120 Nov 138
Sylvania 1-366 Feb 114; 1-502-1 Apr 120; 1-512 (Clinic) Mar 52; 1-527 (Clinic) Dec 102; 1-533 (Clinic) Oct 64

Teletone 149 July 105
Western Auto D2919 Aug 98
Westinghouse H203 AM-FM Apr 118; Westinghouse H203 AM-FM Apr 118; V-2150-176 Mar 143; V-2233 Dec 136; V-2340 (Clinic) Dec 101

Zenith J2026R Apr 118; 5L42 Nov 136; 6C05 Nov 138; Series H (Clinic) Aug 84

Telephone Line TV Transmission (RM) Feb 8

Television
1956—Year of Decision (Lachenbruch) Jan 45
Agc Circuits, Troubleshooting (Glickstein)
Part I—Types and operation May 46
Part II—Isolating defects, service notes June 40
Airborne (What's New) Nov 53
Airplane Relay Telecast (RM) Jan 10
Amplifier, 2-band (Pat) Apr 115
Antennas—See Antennas

Audio
De-emphasis; pre-emphasis (Clinic) Jan 70
Feedback Circuits† Jan 64
Improving Your (Crowhurst) Jan 64
Improving Low-Priced Sets (Lundy) Apr 58
Multiple Speakers† Jan 67
Noise Attenuation or Elimination† Jan 36
Sound If Circuits† Jan 37
Tone Control, Automatic† Jan 39
Using Your Hi-Fi System† Jan 64

Australian (Corres) Apr 18
Beam Afterglow† Jan 38
Britain Takes on Commercial (Dresser) Jan 68
Certification Program, Government June 39
Channel Allocation† Jan 45; (RM) Sept 6; (RM) Oct 8

Circuitry
Bendix† July 41
Capehart CX-385† July 40
Color Killert† May 48
Conrac Fleetwood† July 41
Deflection Output† Jan 39
Du Mont RA-340† July 40
Magnavox† July 41
Trends in Receiver (Scott) July 40
Zenith† July 41

Closed Circuit (See also Television, Industrial (RM)) July 8

Color
Adjustment Problems (Mandl) Mar 44
Colordapter* (Vartanian and DeGrasse)
Part I—Color reception with black-and-white receiver for \$85 and up; junk-box owner might do it for \$50 Jan 40
Part II—Color wheel; drive mechanism; alignment and adjustment Feb 97
Correction (Corres) Apr 12; Oct 22

Demodulator Alignment (Cerveny) July 34
Field Service Experiences With (Rhodes) May 48
Future of (Gernsback) Jan 35
Information Theory† Apr 100
Intermittent† May 48
Killer
Circuits† May 48
Transistor (Pat) Aug 105

Kinescope
Color (Pat) Jan 169
Three-Gun (Pat) Jan 169

Matrix Operation, Y Signal in (Middleton) May 44

NTSC Signal Analyzed June 52
Receiving Tubes (Kass) Jan 59
Single-Gun Tube (RM) Dec 12
Test Equipment (See also Test Equipment) (Mandl) Jan 105
Traps in Receivers (Mandl) Apr 52

Y Signal in Matrix Operation (Middleton) May 44

Deflection Circuit Circuits† Jan 39
Dx July 37; Aug 75; Dec 105
In 1955 (Wheaton) Jan 74
Sunspots and Communications (Tilton) Apr 49

Education (RM) July 8; (RM) Oct 8
Foldover, Intermittent (Thomas) Jan 75
Full-Wave Doubler Heater-Cathode Stress in (Chernish) Sept 40
Headphone Adapter (QB) May 135
Horizontal Sync Balance† Implosions (RM) Aug 6; (Corres) Oct 18

Improving
Low-Priced Sets (Lundy) Apr 58
Your Television Audio (Crowhurst) Jan 64

Industrial
Is Simple (Noll) May 50
Techniques (Noll)
Part I—Pulse generator: sync; scanning; pulse formation Aug 73
Part II—Pulse generator: noninterlaced sweep Sept 44
Part III—Pulse generators: Interlaced system; sync generators Oct 84
Part IV—Camera circuitry Nov 46

Interference
Co- and Adjacent-Channel, Reducing (Noll and Mandl) Oct 61
Filter (What's New) Oct 51
Traps in Color Receivers (Mandl) vs Signal Strength (Stratman) Apr 51

Kinescope
Color (Pat) Jan 169
Three-Gun (Pat) Jan 169

Licensing—Good or Bad? (See also Licensing) (Wheaton) Jan 72

Modular Receiver
Emerson 120306 Schematic June 46
Now—(Shunaman) June 37
Pay-as-You-Go† Jan 47; (RM) May 8
Phones, Low-Z (TTO) Jan 181
Portable (RM) May 6; (What's New) Aug 54
"Rainbow" Tuner, New (Lucas) Jan 48

Rebroadcasting
Airplane relay telecast (RM) Mar 10
Boosters and Satellites† Jan 47
Translators (RM) Mar 6; Nov 8

Receivers
Diagrams—See Schematics
12-Volt (What's New) Feb 42
Designs in 1955 (Manly) Jan 51
Trends in 1955-56 (Scott) Jan 36

Remote Control(s) (Maxwell) (for) 630* (Cliff) Sept 34
CBS† Oct 59
Contract Oct 60
Electromechanical† Sept 36; Oct 58
Electronic† Sept 34
Emerson† Oct 55
Philco† Oct 59
RCA Magic Brain† Sept 35
Sets With (Maxwell) Nov 41
Split-Chassis Set† Oct 60
Sentinel† Oct 58
(of) Traffic (What's New) Apr 49
Whistle Your Set On or Off* (Mark) Jan 58

Schematics
Admiral 2044 Jan 78
CBS-Columbia 1610, 1611 Jan 80
Crosley 466, 467 (Codes A and A1) Jan 82
Emerson 120306 June 46
G-E ER-S-K55 Jan 92
Hoffman Mark 5 Chassis 419, 419U June 84
Motorola TS-525 Series Jan 84
RCA Victor KCS95B, -C Jan 86
P-PT-7030, 1, 4 Jan 48
Westinghouse V-2342, 3 and V-2352, 3 Jan 88
Zenith 19X21 Jan 90
Service Techniques (Middleton) July 36

Servicing—See also Tech Notes; Test Equipment; specific subject (Page references are to TV Clinic unless otherwise noted)

Adjacent-Channel Selectivity July 38
Adjustment Problems (Mandl) Mar 44
Agc Circuits, Troubleshooting (Glickstein)
Part I—Types and operation May 46
Part II—Isolating defects; service notes June 40

Agc in Alignment (Baum and Bowden) Dec 92
Agc Misadjustment Oct 64
Aid (TTO) Nov 142

Alignment
Color Demodulator (Cerveny) July 34
Point Oct 64
Simplified (Scott) May 36
Bench Tool (TTO) May 131
Bending and Rolling Apr 55
Brightness Controls Feb 92
Buzz and Oscillation Sept 42
Capacitor Breakdown Nov 49
Cascode Tuner Installation July 39

Color
Demodulator Alignment (Cerveny) July 34
in 1956† Jan 47
Killer Circuits† May 48
Sets Simplify Oct 95
Sync Poor† May 48
Controls, Checking Nov 50; June 44
Crystal Defective Aug 84
DC Voltage Checks Nov 48
Dealing With Do-It-Yourself (Margolis) Apr 56
De-emphasis; pre-emphasis Nov 70
Devacuuming Picture Tubes Jan 48
Did You Ever? (Highstone) Sept 39
Field Service Experiences With Color TV (Rhodes) May 48
Filter Capacitor Defective (TTO) May 131
Focalizer May 54
Focus May 53
Fuse, High-Voltage Jan 71
Gated-Beam Discriminator Oct 63
Gimmick (TTO) July 118
Hazard on the Bench (Welz) June 57

High-Voltage
Ac Checker (REC) Oct 138
Demonstrator (Wilson) June 43
Discharger (TTO) Nov 143
Doubler Mar 52
Failure June 45
Fuse Jan 71
Rectifier July 39
Supplies, Something New in* (Sanford and Burnham) Mar 77

Heater-Line Resistor
Horizontal
Drive Aug 82
Jitter July 39
Pull Mar 52
Hue May 49
Hum and Buzz Mar 51; Apr 54
Ion Burns on 5AXP4 June 45
Intercarrier Buzz (McRoberts) June 42
Intermittent Color May 48
Intermittents, Tracking Down (Middleton) Dec 104
It's a Matter of Psychology (Slaughter) Jan 55
Line Fuse Sept 43
Lucite Scratches (TTO) July 118
Negative Picture Mar 52
Noise-Immunity Circuits; Rapid Repair Techniques (McRoberts) Dec 107
Noise Inverter Oct 64
Oscillation in Picture Jan 71
Phase Reversal in Picture Sept 43
Picture Overload June 45
Picture Silvery Dec 102
Raster Narrow Dec 101
Ratio-Detector Alignment Sept 42
Rf Oscillator Feb 96
Ringing in Raster Aug 82
Sound Gain Dec 102
Sound If July 39; Sept 42
Sync Poor, No Sound Oct 64
Tearing Feb 95
Techniques (Middleton) July 36
Time Savers, Service Shop (Katal) Nov 44
Tinting† May 49
Tracking May 54
Tube
Checks Nov 50
Hot 6CB6 Aug 84
Substitution Dec 102

Uhf
Tuner Section Inoperative Apr 55
Strip Installation June 45
Universal Kit (Highstone) July 33

Vertical
Foldover Aug 83
Hold Apr 55
Nonlinearity May 54
Sync Aug 84
Synchronization Problems (Quirk) Mar 48

Video
Peaking (TTO) May 131
Weak, Rx for (Glickstein) Nov 50
Voltage and Resistance Checks† Nov 51
Whistle, 15-kc Nov 49
Width Insufficient Jan 71
Yoke Shorted Jan 71
Signal Troubles Before the Receiver (Swan) Aug 77
Spot Wobbler (Pat) Mar 112

Station List (Correct to Dec. 1, 1955) Jan 76; Supplements Feb 8; Mar 6; Apr 6; May 8; June 6; July 8; Aug 6; Sept 10; Oct 16; Nov 14; Dec 18



"Jim used to be an auto mechanic."

TECH-MASTER for '57 . . . Excitingly New!

VIDEO THEATRE ★ VIDEOPHILE ★ GOLD MEDAL TV ★ HI-FI KITS

Brochure mailed on request

CHRISTMAS GIFT OFFER

FREE—12" HI-FI SPEAKER with TWEETER with each purchase of a GOLD MEDAL TV CHASSIS (in addition to SPEAKER supplied).

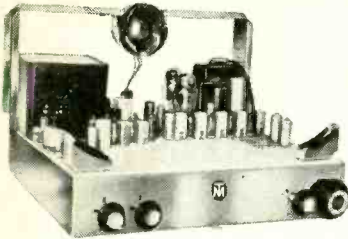

The "GOLD MEDAL" #2430-N

OPERATES all 21", 24" and 27" (90°) Picture Tubes with unexcelled performance in Brilliance, Clarity and Fringe Area Reception. This TV Receiver is an improved version of the former TECH-MASTER #2430-9 that sold for \$262.50.

Note the new low price!

- Latest #630 Type Advance Circuitry, using 30 Tubes.
- New Hi-Sweep Auto Transformer System for added brilliance.
- Full 4 Mc Band Width for picture clarity and definition.
- 5 Microvolt Sensitivity assures fringe area reception.
- New System of picture and sound synchronization.
- New Type Cascade Tuner with provisions for UHF.
- Picture Expander Control for low line voltage conditions.
- Full Horizontal and Vertical Blanking.
- Quick Action Keyed AGC circuit for stabilized control.
- Chassis beautifully plated in gleaming nickel.

Dimensions 20 1/4" W x 16 1/4" D

Shipping Weight 65 lbs.

COMPLETE ready to operate including all Tubes, CRT Brackets, 12" Speaker, Knobs, Etc. (less CRT) \$194.50

CUSTOM-BUILT CABINETS FROM FACTORY TO YOU

3 LEADING 1956 STYLES in Mahogany or walnut (blond 10% extra) • Ready drilled for any # 630 TV chassis and cut out for any 16", 17", 19", 20" or 21" picture tube at no extras in price • Also supplied with undrilled knob panel for any other TV set • EVERYTHING NECESSARY for an easy Perfect chassis and CRT assembly is included • Each cabinet is delivered complete as pictured with mask, safety glass, mounting brackets, backboard, backcup, hardware and assembling instructions • Each cabinet is shipped in an air cushioned carton from FACTORY to YOU!

GEM \$35.91



GEM also available for 24" or 27" picture tube \$59.54

H-25" W-26" D-22"

WESTCHESTER \$88.70



H-41" W-26" D-25"

MANHATTAN \$53.43



MANHATTAN also available for 24" or 27" picture tube \$79.22

H-39" W-25" D-23"

WESTINGHOUSE OR CBS PICTURE TUBES

BRAND NEW in Factory Sealed Cartons—With a Full Year Guarantee

17" 70° #17BP4A \$22.66 | 21" 70° #21EP4B \$32.21 | 24" 90° #24CP4A Aluminized \$48.99 | 27" 90° #27EP4A Aluminized \$74.31

#630 SUPER DELUXE 31-TUBE TV KIT

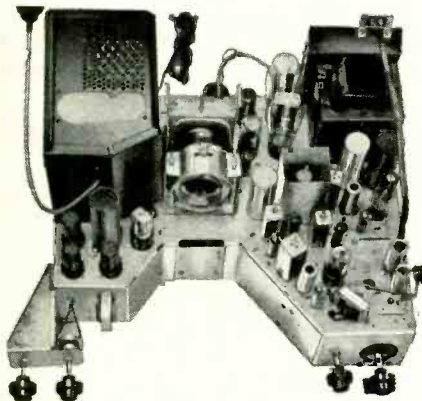

Engineered in strict adherence to the genuine RCA #630, plus added features ★ ★ ★ ★ ★

- Operates 21" and All 70° Picture Tubes
- Standard Cascade Turret Tuner for DX
- Cosine 70° Deflection Yoke for Definition
- Original 630 Synch. Chain for Stability
- 16 KV for Clarity and Brilliance
- Fast Action Pulse Keyed AGC
- Large Concert-tone 12" PM Speaker

NOW! You receive a COMPLETE SET of PARTS and TUBES. Everything needed is included, even WIRE and Solder. You will enjoy building the Chassis with "LIFE-SIZE easy to follow step-by-step ASSEMBLING INSTRUCTIONS" included with KIT. We pay the New Federal Excise Tax.

\$109.98 NEW EXCISE TAX INCLUDED (less CRT)

Licensed under RCA patents

Similar TV KIT for 24", 27" or any 90° CRT \$119.44

21" TV CONVERSION KIT

NOW . . . Anyone with even a limited knowledge of TV—can Convert any Size, any Make TV RECEIVER to operate 21" or any 70° Picture Tube.

COMPLETE SET OF ESSENTIAL PARTS includes matched set of Todd 70° COSINE DEFLECTION YOKE and TODD HV FLYBACK TRANSFORMER, FOCALIZER, 20KV FILTER, DRIVE TRIMMER, LINEARITY COIL, CONDENSERS, RESISTORS.

Your Price . . . \$13.97 List Price \$33.50

Incl. CONVERSION MANUAL with Step-by-Step Instructions & Diagrams.

Similar Kit for 24" or 27" CRT \$15.98

UNIVERSAL Picture Tube MOUNTING BRACKETS

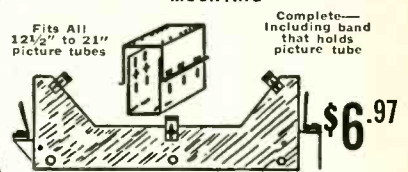

\$6.97

PULSE KEYED AGC KIT

Latest type, most accurate and the easiest Kit to install in any make TV RECEIVER including the #630. Improves performance and insures a steady picture on all channels.

COMPLETE SET OF PARTS \$4.59 Including 6AU6 tube & Instructions

STANDARD CASCADE TUNER

For better all around performance Complete with tubes and Brooks CASCADE MANUAL with step-by-step instructions and all extra parts needed.

\$15.97

FLYBACK TRANSFORMER

Latest single 1B3 type, for the 21" and all 70° Picture Tubes. It is similar to the popular No. X-053 and goes up as high as 16KV. With it you receive easy-to-follow instructions and schematic diagrams that apply to build, convert or improve practically all makes of TV Receivers

\$4.86

COSINE DEFLECTION YOKE

The latest achievement in the 70° type, with complete wired network. Will add new life to any TV Set, in brilliance, clarity and sweep. This is the same type we supply with our Kits. With it you receive easy-to-follow instructions and diagrams

\$4.92

18KV FLYBACK TRANSF.

This new Flyback Transformer now makes 90° conversions easy on any make TV Set. Customers report excellence on 24" and 27" TV sets built or converted with this Transformer. Instructions and schematic diagrams included

\$5.24

COSINE DEFLECTION YOKE

NEW 90° TYPE, with complete wired network. It solves all problems formerly sought for, in 90° Yokes, for undistorted clear pictures and ease of overall sweep. Instructions and schematic diagrams included for building, replacing and converting

\$5.98

TV CRYSTAL-CLEAR LUCITE MASKS

Framed in Rich Goldleaf Finish

Tube Size	Overall Dimensions	Price
17"	Rectangular 13 1/8" x 16 1/2"	\$ 4.56
21"	Rectangular 16 1/2" x 21 1/4"	6.92
24"	Rectangular 20 1/4" x 25 3/4"	11.84
27"	Rectangular 20 1/4" x 26"	12.18

Mention type and number of CRT used

TV PLASTIC OPEN MASKS

Used in conjunction with safety glass

17"	Rectangular 16" x 19"	\$1.49
21"	Rectangular 18" x 22 1/2"	2.38
24"	Rectangular 21" x 26"	4.93
27"	Rectangular 21" x 26"	4.93

Mention type and number of CRT used

TV SAFETY GLASS in HANDY SIZES

16" x 20"	\$2.94	18" x 22 1/2"	\$5.16
16" x 22"	3.97	21" x 26"	5.87

*Available in new tinted grey 50c extra

Brooks LIFE-SIZE TV INSTRUCTIONS \$1.25 postpaid for building any #630 TV Receiver from the Original 10" to the latest 27"	HINTS FOR BETTER PERFORMANCE 50¢ postpaid on your #630 TV receiver	Brooks CASCADE MANUAL, how to install Cascade Tuner in any make TV Set. 25¢ postpaid
90° TV CONVERSION MANUAL, how to convert any TV SET to 24", 27", etc. 50¢ postpaid	70° TV CONVERSION MANUAL, how to convert any TV SET to 17", 21", etc. 50¢ postpaid	A.G.C. STEP-BY-STEP INSTRUCTIONS, how to add A.G.C. to any make TV Receiver 25¢ postpaid

BROOKS RADIO & TV CORP., 84 Vesey St., Dept. A, New York 7, N.Y. TELEPHONE CORtland 7-2359

Tape		
Process (RM)	June	8
Player (What's New)	Dec	57
Recorder (What's New)	July	43
Telephone-Line Transmission (RM)	Feb	8
Test Equipment—See Test Equipment		
Transmitter, Portable (RM)	May	8
Trends in 1955-56 TV Receivers (Scott)	Jan	36
Tubes—See Tubes		
Tuner		
Neutrode—New Vhf-Uhf (Lucas)	July	30
New "Rainbow" (Lucas)	Jan	48
Uhf vs Vhff Jan 45; (RM) Sept 6; (RM) Oct 8		
Viewing Cyclotron Targets (Schulke)	Jan	44
Weak Video, Rx for (Glickstein)	Nov	50
Whistle Your TV Set On or Off* (Mark)	Jan	58
WWTV—World-Wide (Shunaman)	Sept	37
TEST EQUIPMENT—See also specific subject; servicing		
Ac-Dc Probe* (Rhita)	May	39
Adapter, Test (TTO)	Jan	181
Af-Rf Signal-Tracer-Generator* (Shields)	Aug	58
Amplifiers		
Chromatic	Jan	110
Compensating Oscilloscope (Middleton)	Apr	43
Transigner* (Frantz)	May	42
Audio		
Frequency Meter, Compact* (McCready)	Oct	107
Generator, Adapter for Heathkit AG-9 (TTO)	Oct	143
Tester-Audio Amplifier* (Davidson)	Dec	40
Balance Generator and Multivibrator, Transistorized (Braunbeck)	Feb	46
Bar Generator†	Jan	106, 108
Syncing (REC)	May	137
Understand Your Color (Middleton)	June	52
Battery Meter (What's New)	Feb	43
Calibrators		
(for) Ac Voltmeters* (Kaufman)	Nov	40
Preset Af* (Queen)	June	56
Transistorized (REC)	Feb	122
Vhf Weston 895†	May	36
Capacitor		
Bridges, Improving (TTO)	Jan	180
Check, Quick (TTO)	June	109
Checker†	Aug	55
Knight F119* (Kramer)	May	40
Chroma Probe* (Rodey)	May	38
Chromatic Amplifier	Jan	110
Probe†	Jan	109
Circuit Tester, Robot (Rymsha)	July	55
Compass, Electronic, Orients TV Antenna* (Turner)	Jan	118
Color TV—See also specific instrument		
Black-and-White Equipment Used in†	Jan	110
Test Equipment (Mandl)	Jan	105
Continuity Tester (REC)	Apr	121
Delay and Timing Generator (Jaski)	Sept	50
Demodulator Probe		
Correction	Mar	148
Peak-Reading, Conversion to (TTO)	July	117
Dip Meter, Transistorized* (Queen)	May	34
Discriminator, Crystal (Pat)	May	125
Dot Generator(s)†	Jan	105, 109
Stabilized* (Hansen)	July	52
Dot-Bar Generator(s)†	Jan	109
Improving Heathkit LP-1 (REC)	Nov	126
Electronic Switch for (REC)	Nov	126
Flyback Tester (REC)	June	114
Scope (REC)	Sept	135
Generators—See typed generator		
Harmonic-Distortion Meter, Heathkit HD-1†	Aug	48
High-Impedance Probe (REC)	Aug	102
High-Voltage Supplies, Something New in* (Sanford and Burnham)	Mar	77
Intermittent Set Tester* (Dewar)	Mar	64
Kits†	Aug	57
Low-Capacitance Probe* (Rhodes)	Nov	34
Meters—See type of meter		
Modulator, Grounded-Grid (REC)	May	137
Monitoring by Feedback Techniques (RM)	Apr	8
Multimeter		
Knight Kits (TTO)	Sept	142
Transistor Checker* (Prensky)	Aug	68
Multitester†	Aug	55
Multivibrator and Balance Generator, Transistorized (Braunbeck)	Feb	46
Needed, What Is? (Mandl)	Aug	55
Oscillator(s)		
Audio, Transistor (Pat)	Dec	141
Pierce, Stabilized (Pat)	Aug	106
R-C, New (REC)	Jan	171
R-C Controlled (Correction)	Apr	114
Wide-Band Crystal, Build* (Queen)	Nov	36
Oscilloscope—see Scope		
Output Meter, Af (REC)	Jan	173
Peak-Reading Probe (TTO)	July	117
Potentiometer, Standard, for Precise Measurements* (Frantz)	Feb	48
Correction (Corres)	Apr	14
Probes—see type of probe		
Pulse Calibration (Pat)	May	125
Radio H Tester* (Rhita)	Feb	151
Rectifier Tests (TTO)	Jan	182
Robotester (RM) Mar 6; (Rymsha) July 55		
Sawtooth Generator (TTO)	June	109
Scope(s)†	Aug	56
Amplifier, Compensating (Middleton)	Apr	43
Audio Test Signal, Scope Delivers (Wolf)	Dec	62
Blanking, Heathkit OM-1 (REC)	July	111
Calibrator, Transistorized* (Bohr)	Feb	44

Flyback Tester (REC)	Sept	135
Probe* (Rhodes)	Nov	34
TV Set to (QB)	Mar	142
Signal Generators (see also Bar, Sweep, etc.)†		
Af-Rf, and Tracer* (Shields)	Aug	56
Audio* (Greenlee)	Aug	58
Chroma* (Rhodes)	Sept	48
Heathkit AG-9†	Jan	112
Squarer, Adding a (Corres)	May	79
Surge Supply for Intermittents* (Greenlee)	Jan	18
Sweep Generator, Understand Yours Better (Middleton)	Dec	58
Test Lead, Universal (TTO)	Mar	88
Test Stand, Revolving (TTO)	Feb	132
Three-Wire Line Plug for Timing and Delay Generator* (Jaski)	Apr	129
Transigner* (Frantz)	Nov	112
Transistor	Sept	50
Checker (RM)	May	42
for \$1* (Bohr)	Apr	6
Multimeter* (Prensky)	Oct	109
Socket (TTO)	Aug	68
Tube Tester(s)† Aug 56; (Swontek) Nov 38	Jan	180
Automation in (What's New) Feb 43; Apr 48	Jan	171
CRT, Improved (REC)		
New Type Tubes		
Setting for (Barbee)	Sept	54
Correspondence	Feb	18
TV, New (Scott)	Mar	81
20,000-ohms-per-volt Meter†	Aug	55
Ultrasonic Tester (Pat)	Apr	116
Vertical Sync Tracer (TTO)	May	133
Voltmeter†	Aug	55
Long-Storage (Pat)	June	104
Protect Your (TTO)	Aug	110
Query (QB)	Sept	128
Vtm's†	Aug	55
Calibrating Ac* (Kaufman)	Nov	40
Filter Modification (TTO)	Nov	132
New, Easy-to-Read (Scott)	Apr	44
Servicing is Not So Simple (Middleton)	Sept	46
Waveform Generator* (Bukstein)	July	58
Wavemeter		
Amplified (REC)	Aug	102
Transistorized (QB)	Mar	141
What Is Needed? (Mandl)	Aug	55
Thermal Switch (QB)	Sept	127
Thermistor Thermometer, Versatile* (Squires)	Apr	75
Thermostat, Wireless (RM)	Feb	6
Three-in-One Amplifier* (Sharpe)	Mar	53
Thunderbird Volume Control (REC)	Dec	132
Time-Constant Amplifier (Pat)	Nov	140
Time Constants, What They Do (Manly)	Mar	36
Timing and Delay Generator* (Jaski)	Sept	50
Tracking Down Intermittents (Middleton)	Dec	104
Tools, Three-Wire Line Plug on Transigner* (Frantz)	Nov	112
Transigner* (Frantz)	May	42
TRANSISTOR(S)—See also Transistor(ized)		
Characteristics of General-Purpose (Turner)	Feb	40
Checker (RM)	Apr	6
for \$1* (Bohr)	Oct	109
Multimeter* (Prensky)	Aug	68
Class B for* (Bohr)	May	55
Fusing (TTO)	Oct	135
High-Power (Pat)	Apr	116
Identifying (Kampf)	June	68
Maintenance and Checking†	Dec	82
Mount, Novel (TTO)	Oct	144
Self-Powered (Pat)	Feb	129
Shipping Tube (TTO)	Sept	146
Socket (TTO)	Jan	180
Subminiature (RM)	June	6
Symbols (Corres) Jan 18; Aug 10; Sept 18; Nov 18	Aug	6
Transigner* (Frantz)	May	42
Types, Confused About? (Penfield)		
Part I—Junction; point-contact; surface-barrier; intrinsic-region units	Oct	104
Part II—Review of lesser known; future Uhf (RM)	Nov	78
	Apr	6

TRANSISTOR(IZED)—See also Transistor(s); specific subject		
Amplifier		
High-Gain, Audio* (Braunbeck)	June	30
for Interflex Tuner* (Grace)	Mar	51
Calibrator (REC)	Feb	122
(Circuit Design Speeded by) Transigner* (Frantz)	May	42
Color Killer (Pat)	Aug	105
Demodulator Probe (Correction)	Mar	148
Dip Meter* (Queen)	May	34
Golf Ball	July	79
Intercom With 0.6-Watt Output* (Turner)	July	48
Microphone, Wireless* (McCready)	June	36
Multivibrator and Balance Generator (Braunbeck)	Feb	46
-Operated Geiger Counter* (Knight)	Apr	59
Preamp, Hi-Fi, for Easy Listening* (Owens)	Sept	59
Relay Circuit (Pat)	Oct	141
Radios—See Radios		
Regulator (Pat)	Mar	114
Scope Calibrator* (Bohr)	Feb	44
Shortwave Regenerator* (Bohr)	Aug	34
Transceiver (REC)	July	113
Transmitter, Flea-Power* (Chernof)	Oct	52
Trigger Circuits, Junction (Schenkerman)	Aug	37
TV Pickup (RM)	Oct	8
Wavemeter (QB)	Mar	141
Traps in Color TV Receivers (Mandl)	Apr	52
Trends in		
Am Receivers (Scott)	Aug	30
TV Receiver Circuitry (Scott)	July	40
TV Receivers, 1955-56 (Scott)	Jan	36
Troubleshooting Age Circuits (Glickstein)		
Part I—Types and operation	May	46
Part II—Isolating defects; service notes	June	40
True Shirt-Pocket Radio* (Queen)	July	60
Tube-Advertising Policy of R-E Jan 57; Feb 8; Mar 63	Nov	38
Tube Testers (Swontek)	Nov	38
Tubes		
110° Picture (RM)	Dec	14
Color TV Receiving (Kass)	Jan	59
New, and Transistors Jan 165; Feb 112; Mar 129; Apr 112; May 118; June 99; July 100; Aug 95; Sept 124; Oct 125; Nov 131; Dec 124	Feb	14
Post-Acceleration (Corres)		
Testers—See Test Equipment		
Tuners—See Aiso Audio		
Indicator, FM Tuning (QB)	Feb	125
Synchrodyne (REC)	Mar	136
TV		
Neutrode—New Vhf-Uhf (Lucas)	July	30
"Rainbow" New (Lucas)	Jan	48
Transistorized Amplifier for Interflex* (Grace)	Mar	59
Two-Way Instrument Checks TV's and Radios* (Shields)	Aug	58
TV Receiver Designs in 1955 (Manly)	Jan	51

U

Underground TV Master Antenna (Miller)	Oct	98
Understand Your Color Bar Generator (Middleton)	June	52
Understand Your Sweep Generator (Middleton)	Mar	88
Unique AM Tuner Improves Audio Quality* (Vogelgesang)	Dec	80
Universal Experimental Chassis* (Freund)	Sept	79
Universal TV Service Kit (Highstone)	July	33
Upside-Down Amplifier* (Augspurger)	Nov	54

V

Ventilating Fans, Control Unit for* (McCready)	May	86
Vertical Synchronization Problems (Quirk)	Mar	48
Viewing Cyclotron Targets (Schulke)	Jan	44
Vocatrol (Corres)	Jan	16
Voltage Regulator, Electronic* (Hedge)	Apr	88
Volume Control Switches (TTO)	Feb	133
Vtm Servicing Is Not So Simple (Middleton)	Sept	46

W

Watchmaster, Servicing the (Darr)	May	90
Waveform Generator* (Bukstein)	July	58
Weather Reports, Multiplex (RM)	Apr	6
What Test Gear Is Needed (Mandl)	Aug	55
Whistle Your TV Set On or Off* (Mark)	Jan	58
Wide-Band Crystal Oscillator, Build a* (Queen)	Nov	36
Wireless Mike, Transistorized* (McCready)	June	36
WWTV—World-Wide Television (Shunaman)	Sept	37

Y

Y Signal in Matrix Operation (Middleton)	May	44
--	-----	----

KEY TO SYMBOLS AND ABBREVIATIONS

* Construction Articles
 † Section of full-length article

Clinic Television Clinic
 Corres Correspondence
 Pat Patents
 QB Question Box
 REC Radio-Electronic Circuits
 RM Radio Month
 TTO Try This One

Regular departments not indexed are Business, Technicians' News, New Devices, People, Technical Literature, Books.

END



"Just hold still a minute, sir, a little solder will do the trick."

LAFAYETTE SENSATIONAL VALUES! IN COMPLETELY WIRED TEST EQUIPMENT AT LESS than the PRICE of KITS!

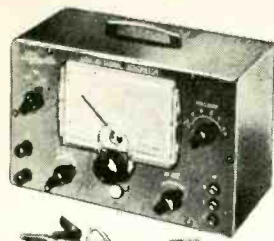

LAFAYETTE SIGNAL GENERATOR

NEVER BEFORE HAS A COMPLETELY WIRED AND TESTED INSTRUMENT OF SUCH ACCURACY AND QUALITY BEEN OFFERED AT SUCH A PRICE!

- FREQUENCY 120 KC TO 260 MC
- 120 KC TO 130 MC ON FUNDAMENTALS
- LABORATORY ACCURACY AND QUALITY

A completely wired and tested instrument not to be confused with units sold in kit form at almost the same price, but with a quality and accuracy of instruments 3 to 4 times its price. Six overlapping ranges generate signals of 120KC — 320KC, 320KC — 1000KC, 1MC — 3.2MC — 11MC, 11MC — 83MC and 37MC — 130MC all on fundamentals with calibrated harmonics from 120MC to 260MC. Selector switch gives instant choice of ranges. Switch gives choice of internal modulation of 400 CPS or use of any external source at other frequencies. For audio testing the 400 cycle signal can be used separately.

22.50

Outputs are unmodulated RF, modulated RF and 400 CPS audio. RF output is in excess of 100,000 microvolts and jacks are provided for choice of either high or low RF output. Stability is insured by special circuit design. Has a fine adjustment RF control. AF output is 2-3 volts, AF input is 4 volts across 1 megohm. Large clear 5 inch etched dial plate and pointer are protected by transparent plastic bezel. Common AF terminals for EXT-MOD input and INT-AF for audio tests eliminate need for special AF output connectors. Machine engraved panel lettering. Handsome gray metal case with carrying handle. Measures 6 1/2" x 10" x 4 1/2". Comes complete with pair of leads, AC line cord and plug. Operates on 105-125V 50-60 cycle AC. Shpg. wt., 8 lbs.

LAFAYETTE LSG-10 SIGNAL GENERATOR

22.50

NEW!

LAFAYETTE CAPACITANCE-RESISTANCE TESTER WITH "IN-SET QUICK CHECK"

COMPLETELY WIRED AND TESTED



- TWO INSTRUMENTS IN ONE
- CHECKS ELECTROLYTIC, PAPER, MICA AND CERAMIC CONDENSERS
- 4 DIRECT READING CAPACITY SCALES FROM .00001 MFD TO 1000 MFD
- CHECK FOR OPEN SHORTS, LEAKAGE AND INTERMITTENTS
- 2 RESISTANCE RANGES FROM 100 TO 5 MEGOHM

Here is a "must" for servicemen and lab technicians. A completely self-contained AC operated capacitance and resistance bridge, plus a quick check for in the set testing. Large 5 direct reading scale has 4 ranges of .00001 - .005 MFD, .001 - .5 MFD, 1 - 50 MFD and 20 - 1000 MFD. Resistance ranges are 100-50,000 OHMS and 10,000 to 5 megohm. Quick check feature enables you to check capacitors for shorts, open or intermittent while in circuit—no need to remove them from the set till you're sure they need replacement. Leakage test switch gives

34.50

you choice of 25, 150, 250, 350 or 450 volts for checking leakage under correct potential. Separate power factor control with continuous settings from 0 to 50%. Operation is simple and accurate, using a magic-eye tube as the null detector. Attractively finished steel case with etched panel and rounded corners, measures 14 1/2" L x 8 1/4" H x 5" D. Shpg wt. 19 lbs.

MODEL LC-4

NET 34.50

NEW!

LAFAYETTE CAPACITOR-RESISTANCE TESTER

COMPLETELY WIRED AND TESTED



21.50

- COMPLETELY WIRED AND TESTED
- CHECKS ALL TYPES OF CONDENSERS FOR CAPACITY, LEAKAGE, OPEN SHORTS OR INTERMITTENT CONDITION
- DIRECT READING SCALES FROM .00001 TO 1000 MFD AND 100 TO 5 MEGOHMS

A stable and accurate bridge type circuit measures capacitance in 4 ranges of .00001-.005 MFD, .001 to .5 MFD, 1 to 50 MFD and 20 to 1000 MFD. Two resistance ranges of 100-50,000 and 10,000 to 5 megohms. Check leakage under actual load with choice of 25, 150, 250, 350 or 450 volts available by selector switch. Power factor control from 0 to 50%. Checks for leakage, open, short, or intermittent operation. All readings taken directly off scales after setting magic eye to maximum. Completely self-contained power supply. Attractively finished steel case with rounded corners and etched panel. Operates from 110V AC. Size 9 3/4" L x 7 1/8" H x 5 1/4" D. Shpg. wt. 10 lbs.

MODEL LC-15

NET 21.50

NEW POCKET AC-DC VOM MULTITESTER

2,000 ohm per volt Sensitivity on both DC and AC

- 160 ua 3" METER
- 1% PRECISION RESISTORS
- SILVER CONTACT SELECTOR SWITCH



FULL SCALE RANGES
DC Volts: 0-10; 0-50; 0-500; 0-1000 Volts — AC Volts: 0-10; 0-50; 0-500; 0-1000 Volts—DC Current: 500 ua and 500 ma — Resistance: 0-10K; 0-1 Meg — Decibels: — 20 to +22; +20 to 36 db (0 db — 0.775 V) — Capacity: 250 mmfd to .2 mfd—.005 mfd to 1 mfd—Output Ranges: 0-10; 0-50; 0-500; 0-1000 volts

8.95

Best Buy in America! A very accurate and sensitive VOM. This Multitester is a complete instrument (not a kit) with high quality and sensitive 160 microamp meter; 2000 ohm per volt on both AC and DC. Single selector switch, 1% precision resistors, 3" meter. Features extreme versatility, accuracy and ruggedness. In attractive plastic front panel, with metal bottom for ruggedness and shielding. First capacity range requires 50 volt AC source. Second capacity range requires 10 volt AC source. Size 4 1/2" x 3 1/2" x 1 3/8". Complete with test leads and batteries. Shipping weight 4 lbs.

RW-27A

Complete 8.95

HIGH SENSITIVITY 20,000 OHM PER VOLT DC 10,000 OHM PER VOLT AC MULTITESTER



LOOK AT THESE FULL SCALE RANGES!
D.C. Volts: 0-6; 0-30; 0-120; 0-600; 0-1200; 0-6000 Volts — A.C. Volts: 0-6; 0-30; 0-120; 0-600; 0-1200 Volts — RESISTANCE: 0-10K; 0-100K; 0-1 Meg; 0-10 Megohms — D.C. CURRENT: 0-60 Microamp; 0-6; 0-60; 0-600 Milliamps — DECIBEL: — 20 to +17 db (0 db — 0.774V) — CAPACITY: .0001 - .01; .005-15 mfd — INDUCTANCE: 20-2000 millihenry — OUTPUT RANGES: 0-6; 0-30; 0-120; 0-600; 0-1200 Volts

19.95

The new Lafayette high sensitivity Multitester is a complete instrument (not a kit). In addition to its unusual sensitivity of 20,000 OHMS PER VOLT ON D.C. AND 10,000 OHMS PER VOLT ON A.C., and the extraordinary number and scope of its ranges, it is packed with features that would make it cost at least twice as much if made in this country. Uses 1% precision resistors, silver contacts on selector switch, 35 ua 3" meter. Dependable, rugged and accurate. Even the test leads are heavy duty with high voltage insulation. Voltage source required for low capacity range is 120V A.C., for high range capacity and inductance scale is 6V A.C. Attractive plastic front with metal bottom. Size 6 1/4" x 4 1/4" x 2 1/2". Complete with batteries and leads. Shipping weight 4 1/2 lbs.

RW-30A

Singly, Each 19.95
In lots of 3, Each 19.25

4 AND 6 TRANSISTOR SUPERHET KITS POCKET AND HOME RADIOS FOR SPEAKER AND EARPHONE OPERATION

POCKET SIZE: 4" L x 3-5/16" W x 1" D BUILT-IN ANTENNA! REQUIRES NO EXTERNAL ANTENNA OR GROUND!



Lafayette engineers have designed this fascinating 4-transistor superhet receiver kit in a unique and interesting form. It is, by itself, a completely self-contained, pocket sized personal portable set which operates a miniature earpiece so only you can hear; by plugging into the KT-96 kit listed below, it is instantly converted to a full 6-transistor home radio, complete with speaker for the entire family to enjoy. Circuit features use of 4 transistors (2 high frequency and 2 audio type) plus a germanium diode, 2 I.F. stages and built-in high gain ferrite core and antenna. The result is a sensitive, stable and selective set covering the entire broadcast band. Requires no outside antenna or ground connection. The kit is furnished complete with transistors and all parts, including battery and chassis already drilled and punched. The earpiece and carrying case are necessary items, not supplied. All necessary pictorial and circuit diagrams are furnished with simple, easy-to-follow instructions.

- KT-94 — Kit, shpg. wt., 2 lbs. Net 19.95
- MS-311 — Leather Carrying Case. Net 1.95
- MS-260 — Super Power dynamic earpiece. Net 3.95

2-TRANSISTOR PUSH-PULL OUTPUT KIT WITH SPEAKER SELF-CONTAINED IN BEAUTIFUL PLASTIC CASE.

- CONVERTS 4-TRANSISTOR KIT INTO A 6-TRANSISTOR HOME RADIO WITH SPEAKER

Add a completely transistorized push-pull audio stage to your 4 transistor receiver. Complete stage including speaker and case measures only 3" H x 2 3/8" W x 1 1/8" D. Plugs right into 4 transistor kit above. Converts your 4 transistor set to a 6 transistor plus diodes superhet receiver. Performance equal or superior to commercially wired sets selling at more than twice the price. Kit includes 2 transistors, 2 transformers, 2 1/2" PM speaker, pre-punched chassis, speaker case to hold entire stage, battery, hardware, instructions and diagrams.

KT-96 — Shpg. wt., 1 lb. Net 11.50

LAFAYETTE RADIO

Dept. JL-1

JAMAICA 33; N. Y. 165-08 Liberty Ave. Write for FREE Bargain Packed Catalog!

100 SIXTH AVE., NEW YORK, N. Y.
BOSTON, MASS., 110 Federal St.
PLAINFIELD, N. J., 139 West 2nd St.
NEWARK, N. J., 24 Central Ave.
BRONX, N. Y., 542 E. Fordham Rd.

FREE!
LAFAYETTE
CATALOG



**ELECTRONIC CATALOG
PACKED WITH MONEY SAVERS**

Packed with the largest selection of Electronic, Radio and T.V. Parts, and equipment, PA, Hi-Fi systems tubes, antennas, Transistor Kits, parts and components, Test Equipment, new build your own kits, tools, books, Microscope, drafting equipment, Binoculars, Telescopes, AM Radio, TV and Ham supplies — ALL AT GREAT SAVINGS — For the economy minded servicemen, dealer, engineer and technician. **CHUCK FULL OF BUYS! SEND FOR YOUR FREE COPY TO-DAY.**

35 WATT HI-FI AMPLIFIER KIT WITH METERED OUTPUT AND 4 PUSH-PULL PARALLEL NEW EL84 TUBES

New Lafayette high power amplifier kit with a host of features not in any other single amplifier. Calibrated output meter permits use as either a recording or reproducing amplifier. EL84 power pentodes provide high peak power and low distortion required for better audio quality. Features exceptional control versatility and ample inputs for all associated custom hi-fi equipment. DC operated preamp filaments and balancing adjustment to minimize hum. Meter can be switched to indicate either recording voltage or output level of amplifier. Features rumble filter, loudness control, separate bass and treble controls, silencing switch, speaker selector switch, output balancing adjustment and monitoring jack.



SPECIFICATIONS

FREQUENCY RESPONSE: ± 1 db 20-40,000 cps. **HUM:** 85 db below rated output. **POWER OUTPUT:** 35 watts with 4% total distortion at full rated output. **INPUTS:** TV Sound, Radio, Magnetic Phono, Crystal Phono, Tape. **OUTPUT IMPEDANCE:** 4, 8 and 16 ohms; high impedance for tape recorder. **TUBE COMPLEMENT:** 3-12AX7, 1-12AU7, 4-EL84, 1-5U4. **FEEDBACK:** Negative feedback loops virtually eliminate distortion. **POWER:** 117V, 60 cps, 80/150 watts with auxiliary power receptacles. Removable escutcheon. Size 12 1/2" L x 9 3/4" D x 4 3/4" H. A combination of high power, high fidelity, gleaming beauty and advanced engineering features unmatched at even twice the price. Supplied in complete kit form with simplified easy-to-follow instruction sheets. Shpg. wt., 25 lbs. **KT-115—Complete kit, Net 59.50**

LAFAYETTE'S FM-AM TUNER KIT

- SIMPLIFIED DETAILED INSTRUCTION MANUAL
- MEETS FCC REQUIREMENTS FOR RADIATION
- GROUNDED GRID TRIODE AMPLIFIER
- ARMSTRONG FM CIRCUIT WITH FOSTER-SEELEY DISCRIMINATOR
- AFC DEFEAT CIRCUIT WITH FRONT PANEL CONTROL



The excellence of its design and the quality of its components combine to provide this compact high-fidelity FM-AM tuner with superb characteristics normally found in units costing several times as much, and with performance unbelievable at this low price. Features Armstrong FM circuit with limiter and Foster-Seeley discriminator. Simplified tuning with slide-rule dial and flywheel counterweighted mechanism. AFC defeat circuit combined with tuning control. Attractive etched copper-plated and lacquered finish.

SPECIFICATIONS

FREQUENCY RANGE: FM, 88-108 MC; AM, 530-1650 KC. **ANTENNA INPUT:** FM, 300 ohms; AM, Ferrite loopstick and high impedance external antenna. **CONTROLS:** 2—a function control for AM, FM, PHONO, TV and a tuning/AFC defeat control. **DISTORTION:** Less than 1% rated output. **FREQUENCY RESPONSE:** FM, ± 5 db 20 to 20,000 cps; AM, ± 3 db 20 to 5000 cps. **SENSITIVITY:** FM, 5 µv for 30 db quieting; AM, Loop sensitivity 80 µv/meter. **SELECTIVITY:** FM, 200 KC bandwidth, 6 db down—375 KC FM discriminator peak to peak separation; AM, 8 KC bandwidth, 6 db down. **IMAGE REJECTION:** 30 db minimum. **HUM LEVEL:** 60 db below 100% modulation. **TUBE COMPLEMENT:** 2-12AT7, 1-6BA6, 1-6BE6, 2-6AU6, 1-6AL5 plus 1-6X4 rectifier. **SIZE:** 5 1/2" high x 9 3/4" wide x 9 1/2" deep (excluding knobs). **CONSUMPTION:** 30 watts. For 110-120V 60 cycles AC. Less metal case. Shpg. wt., 9 lbs. **KT-100—Complete kit, less cage, Net 34.95**
LT-10—Completely wired, Less metal case, Net 52.50
ML-100—Metal cage for above, shpg. wt., 3 lbs., Net 5.00

New!



**HIGH FREQUENCY TWEETER
WITH ACOUSTIC LENS
DIRECT IMPORTATION
MAKES THIS PRICE POSSIBLE!**

- FREQUENCY RESPONSE FROM 2000 CPS TO BEYOND AUDIBILITY
- LOUVERED ACOUSTIC LENS FOR UNIFORM SOUND DISPERSION
- HANDLES 25 WATTS OF POWER
- PRICED EXCEPTIONALLY LOW

14.95

New high frequency tweeter featuring a louvered acoustic lens for uniform sound dispersion and capable of handling up to 25 watts of distortion-free power. The directional tendency of high frequency notes is overcome by the natural wide dispersion angle of the short horn and the acoustic lens which disperses and radiates the high notes smoothly throughout the entire listening area. The lens is detachable for panel mounting, with a separate base for the tweeter furnished for external mounting where desired. Aluminum voice coil has 16 ohms impedance. Size: 4 1/4" long x 3" diameter, lens extends 2 1/2". Requires a crossover network, preferably one with a level control, such as the LN-2. With full instructions. Shpg. wt., 5 lbs. **HW-7 Net 14.95**

METAL-CASED CONE TYPE HI-FI TWEETER

FREQUENCY RESPONSE 2000-16,000 CPS · HANDLES 20 WATTS OF POWER

Highest quality cone type high frequency tweeter having a range from 2000 to 16,000 cycles. Especially efficient at higher end of audio spectrum where other cone type tweeters tend to lose clarity and volume. Entirely closed in a metal case with a base so that it can stand by itself or be mounted on a flat surface with mounting bracket supplied. Rated to handle 20 watts of power. A crossover network is required; the Lafayette LN-2 is ideal. Voice coil impedance 8-16 ohms. Size: 3 3/4" x 2 1/8" x 3" Diam. Shpg. wt., 3 lbs. **HK-3 Net 5.95**



CROSSOVER NETWORK

- CAPACITIVE-INDUCTIVE NETWORK WITH CROSSOVER AT 2000 CPS
- BUILT-IN LEVEL BRILLIANCE CONTROL

8.75

The frequencies above 2000 cycles are channeled to the high frequency tweeter by means of the high-Q inductance and capacitance comprising this efficient crossover network. The highs and lows are brought into acoustic balance by means of a continuously variable level-brilliance control. Control has a 2 1/2 ft. long cable for remote mounting. Network matches 8-16 ohm speakers with insertion loss reduced to a minimum. Enclosed in metal case 6" L x 2 3/8" H x 2 3/8" D. With full instructions. Shpg. wt., 5 lbs. **LN-2 Net 8.75**

**2 WAY SPEAKER SYSTEM
40-16,000 CYCLES**



This 2-way speaker system is another excellent buy for the moderate purse. It is basically the same as the SY-85 system described at the top of the page, but incorporates the deluxe SK-68 speaker with 21.5 oz. Alnico V magnet. This results in more efficient reproduction and extension of the lower register. Complete system includes the SK-68 12" 25 watt woofer, HK-3 cone type tweeter and LN-2 crossover network with level-brilliance control. Range of system 35-16,000 cycles. Shpg. wt., 18 lbs. **SY-87—Complete System, Net 27.50**
SY-86—Complete System, same as above except the HW-7 Tweeter with acoustical lens is supplied instead of HK-3. Shpg. wt., 20 lbs., Net 36.50

Lafayette Radio 165-08 Liberty Ave.
Dept. JL-2 JAMAICA 33; N. Y.

SEND FREE LAFAYETTE CATALOG

NAME _____

ADDRESS _____

CITY _____

ZONE _____

STATE _____

**CUT OUT
AND MAIL
TODAY!**

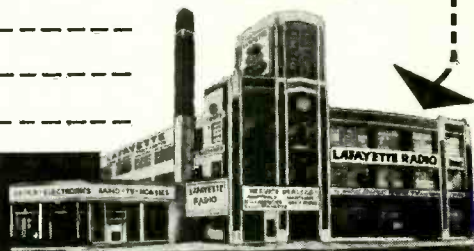

New! LAFAYETTE
Mail Order Center

HQ for the 5 TOP QUALITY brands of

TUBES

AT SENSIBLE PRICES!

- Individually boxed • First quality only
- Brand New • 90-DAY RETMA guarantee
- No rebrands • No private brands • No rejects

DUMONT 5" SCOPE, MODEL 274A

(Worth \$150.00) Exc. Cond. **\$75**

1B35	\$ 3.50	304TL	10.50	1820	3.00
1B35	50.00	307A	.60	1824	1.25
CL-2	10.00	355A	12.00	1825	.30
2C35	2.00	357A	15.00	2050	1.00
2C39A	2.50	358E	9.00	2051	.85
2C51	3.25	403A	1.25	5517	1.35
2C53	9.95	403B	2.75	5636A	2.95
2D21	7.00	404A	12.50	5687	3.00
2E24	2.75	416A	29.00	5642	1.00
2K25	19.75	416B	29.50	5643	5.00
2K45	35.00	417A	2.75	5646	4.50
2K55	15.00	417A 5642		5651	1.40
3B24	1.50		12.50	5654	1.40
3B24W	5.00	*450TH	44.00	5654	4.50
3B29	1.50	KU-810	3.50	5670	1.00
3BP1	1.40	WL855/65B		5675	8.00
3C23	4.00		90.00	5676	1.15
3C31	1.50	717A	2.00	5687	2.75
3C45	6.00	GL673		5691	4.75
3D21A	3.95	703A	1.10	5692	5.00
3D31	3.00	717A	1.35	5693	4.75
3J30	30.00	723A B	7.85	5703WA	4.50
*4-65A	16.50	725A	3.50	5718	2.50
*1-125A	30.25	*507L	40.00	5731	3.00
4-250A	35.00	800	.90	5725	2.50
4-400A	58.50	802	2.25	5726	.60
4B24/EL3C	48.00	803	2.25	5744	1.25
4C35	13.50	805	5.00	5749	1.25
4E27	8.50	807	1.20	5763	1.20
*4PR60A	37.50	807W/5933		5812	1.00
5C22	10.10		1.75	5812	.80
6AK5W	1.40	813	8.00	5840	6.00
6C21	.20	814	4.00	5879	1.40
6C21	10.00	815	2.00	5881	2.35
6J4	1.90	816	1.00	5910	.45
6J6W	1.00	836	1.50	5913	.50
6SE	1.00	855	1.25	6113	4.95
FG32	4.50	838	.70	6112	4.95
*35TG	2.45	845	5.00	6130	3C45 6.00
VCS0/32KV	8.00	866A	1.25	6146	4.55
KK60	3.25	872A	1.25	6181	60.00
KK65	7.00	917	2.00	6183	400.00
HY69	2.50	918	1.50	6189	2.50
GLK72 or 73	4.00	927	1.50	6207	3.00
F123A	5.00	930	1.50	6350	10.00
VXR-130	1.75	954	.35	6539	9.00
203A	2.50	955	.35	6541	3.25
211	3.00	956	.35	8020	2.00
250R	2.95	957	.35	9001	.85
*250TL	14.00	991	.25	9003	1.35
HK253	5.00	CK1005	.35	9004	.50
GL299	6.00	CK1007	.35	9006	.20
304TH	8.75	CK1026	2.35	(SURPLUS)	

and many others, over 1000 types in stock! WRITE!

2 COLOR TUBE CARTONS

Keeps your tube stock neat. New safety partition prevents tube breakage. Distinctive lithographed in glossy red and black. The most distinctive tube carton available today. Minimum quantity: 100 of any one size. Write for case lot prices.

SIZE	FOR TUBE	PER 100
Miniature	6AU6, etc.	\$1.00
GT	6SN7, etc.	1.25
Large GT	183, etc.	1.50
Large G	5U4G, etc.	2.00

WHITE GLOSSY BOXES
Completely blank. No printing or color. Otherwise same as above. Same high quality, same low prices. Specify "WHITE" when ordering. When color is not stated, 2 color cartons will be shipped.

TUBE STACKERS
White glossy only. Ministacker holds 10 Mini. tube cartons; "GT" stacker holds 10 "GT" cartons.
Mini-stacker **PER EACH** \$1.25
GT **PER EACH** \$2.00

SAVE on STACKERS. Either size only \$1.25 per 100 or \$10.00 per case of 1,000, F.O.B., New York!



DIRETRON SELENIUM RECTIFIERS

Full Wave Bridge Type

Max. Amps.	18VAC 14VDC	36VAC 28VDC	54VAC 42VDC	72VAC 56VDC	130VAC 100VDC
1	\$1.35	\$2.30	\$3.70	\$4.80	\$7.40
2	2.00	2.75	5.30	5.90	9.15
2 1/2	2.90	4.10	5.75	7.85	12.70
4	3.50	6.40	11.28	14.35	21.70
6	3.95	7.70	12.75	17.30	29.65
10	5.85	11.38	19.40	24.80	41.25
12	7.30	14.85	22.00	27.75	43.85
20	13.05	25.05	37.25	48.75	78.50
24	14.25	28.75	44.50	57.65	81.00

Complete line of new rectifier transformers, chokes and filter capacitors in stock at all times. May be ordered at same time as selenium rectifiers above for immediate delivery. Write for complete price list. We build other Selenium Rectifiers, Transformers and Chokes to your specifications.

NEW RECTIFIER TRANSFORMERS

Continuous Ratings	1 Amp.	\$ 5.75
PRI: 115V. 60 cycles input	2 Amps.	6.75
SEC: 9, 12, 18, 24 and 36 volts.	4 Amps.	8.75
	12 Amps.	16.65
	24 Amps.	35.65

NEW RECTIFIER CHOKES

Continuous Ratings	1 Amp.	1.5 ohm	\$ 4.95
	2 Amps.	.9 ohm	5.95
	4 Amps.	.6 ohm	7.95
	12 Amps.	.1 ohm	14.95
	24 Amps.	.025 ohm	29.95

FILTER CAPACITORS

Capacity	W. Voltage	Each
400 MFD (in cans, on octal bases)	25 V.	\$1.00
500 MFD	200 V.	1.95
500 MFD	50 V.	85
1000 MFD	15 V.	85
1000 MFD	35 V.	1.50
2000 MFD	50 V.	2.25

WRITE FOR "BARRY'S GREEN SHEET" FREE!

TERMS: 25% deposit with order, balance C.O.D. All merchandise guaranteed. F.O.B. N.Y.C.

BARRY ELECTRONICS CORP.

512 Broadway, Dept. RE, N.Y. 12, N.Y.
Phone: Walker 5-7000

ADVERTISING INDEX

Radio-Electronics does not assume responsibility for any errors appearing in the index below.

Aerovox Corp.	114	National Radio Institute	19-20
Allied Radio Corp.	15, 95-100, 148	National Schools	3
Almo Radio Co.	122	Newark Electric Co.	145
Amperex Electronic Corp.	134	Newark Surplus Materials Co.	144
Amphenol Electronics	10	North American Phillips Co., Inc.	30
Arkay Kits, Inc.	144		
Audel Publishers	152	Oelrich Publications	126
		Ohmite Manufacturing Co.	138
Barry Electronics	164	Opportunity Adlets	150
Bell Telephone Labs.	28, 142	ORRadio Industries	115
Benco Television Association, Ltd.	122	Oxford Electric	126
Bendix Radio	152		
Berkeley (E. C.) & Assoc.	143	Perma-Power Co.	139
Blonder-Tongue Labs.	16	Permo Inc.	153
Bogen (David)	6-7	Phaotron Instrument & Electronic Co.	129
Brooks Radio & Television Corp.	112, 160	Precise Development Corp.	113
Burstein Applebee Co.	147	Precision Apparatus Co.	124
		Progressive Edu-Kits, Inc.	138
CBS-Hytron	17, 26	Pyramid Electric Co.	131
Cantor, (Jack)	126		
Capitol Radio Engineering Institute	25	Quality Electronics	146
Centralab Div. of Globe Union	133, 135		
Century Electronics	128	R-Columbia	110
Cleveland Institute of Radio Electronics	11	Radiart Corp.	24
Cornell Dubilier	24	RCA Institutes, Inc.	27
Coyne Electrical School	121, 145, 151	RCA Service Co.	120
		RCA Test Equipment	158
DeRo Electronics	152	RCA Tube Dept.	Back Cover
DeVry Technical Institute	5, 9	Radio Receptor, Inc.	79
Dressner	126	Radio Television Training Association	29
Dyna Co.	149	Raytheon Manufacturing Co.	13
Dynamic Electronics	114	Rek-O-Kut Co.	150
		Remington Rand Univac	137
Editors and Engineers	148	Rinehart Books Inc.	108, 141, 149
Electro-Voice, Inc.	Inside Back Cover	Rockbar	123
Electronic Brain Enterprises	148		
Electronic Instrument Co. (EICO)	31, 32	Sams (Howard W.) & Co.	23, 111
Electronic Measurements Corp.	117	Scott (Hermon Hosmer)	14
Electronic Organ Arts	146	Service Instruments Co.	136
Electronic Publishing Co., Inc.	134	Sonotone Corp.	109
Elgin National Watch	132	Sound Mart Unlimited	126
Esse Radio Co.	155	Sprague Products Co.	103
E-Z Hook Test Products	148	Stan-Burn Radio & Electronics	146
		Standard Coil Products Co.	93
Futuramic	130		
		Tenna Manufacturing Co.	12
Garfield (Oliver) Co.	118	Trio Manufacturing Co.	91
General Industries Co.	21	Triplett Electrical Instrument Co.	Inside Front Cover
Gernsback Library Inc.	151, 154	Tung-Sol Electric Co.	8
Guide Lamp Div. of General Motors	127	Turner Co.	22
Hawkins (P. E.) Co.	151	University Loudspeakers	18
Heath Co.	64-77	University Microfilm	147
Hershel Radio	151	Utica Drop Forge & Tool Corp.	90
Hi-Lo TV Antenna Corp.	106		
Hudson Specialties Co.	150	Weston Electrical Instrument Corp.	153
Hunter Tool Co.	118	Winegard Co.	110
		World Radio Labs.	139
IBM	125		
Indiana Technical College	144	Xcelite Inc.	148
Instructograph Co.	143		
Jensen Industries	139		
Jerrold Electronics Corp.	119		
		SCHOOL DIRECTORY PAGE 140	
Kedman Co.	149	Baltimore Technical Institute	
Kuhn Electronic Products	146	Candler System Co.	
		Central Technical Institute	
LMB	149	Grantham School	
Lafayette Radio	162-163	Indiana Technical College	
Lektron Specialties	124	Indianapolis Electronic School	
		Milwaukee School of Engineering	
Macmillan Co.	132	Pacific Engineering College	
Mallory (P. R.) & Co.	84, 85	RCA Institutes, Inc.	
Merit Coil & Transformer Corp.	22	Tri-State College	
Moss Electronics Distributing	86-87	Valparaiso Technical Institute	
Musicraft	143	Western Television Institute	

BRANCH ADVERTISING OFFICES: Chicago: 1413 Howard St. Tel. ROGERS Park 4-8000. Los Angeles: Ralph W. Barker and Associates, 600 South New Hampshire. Tel. DUNKIRK 7-2328. San Francisco: Ralph W. Barker and Associates, 582 Market St., Tel. GARFIELD 1-2481.

FOREIGN AGENTS: Great Britain: Atlas Publishing and Distributing Co., Ltd. London E.C. 4. Australia: McGill's Agency, Melbourne. France: Brentano's, Paris 2e. Belgium: Agence et Messageries de la Presse, Brussels. Holland: Trilacton, Heemstede. Greece: International Book & News Agency, Athens. So. Africa: Central News Agency, Ltd., Johannesburg. Capetown, Durban, Natal: Universal Book Agency, Johannesburg. Middle East: Steinmatt Middle East Agency, Jerusalem. India: Broadway News Centre, Dadar, Bombay #14. Pakistan: Paradise Book Stall, Karachi 3.

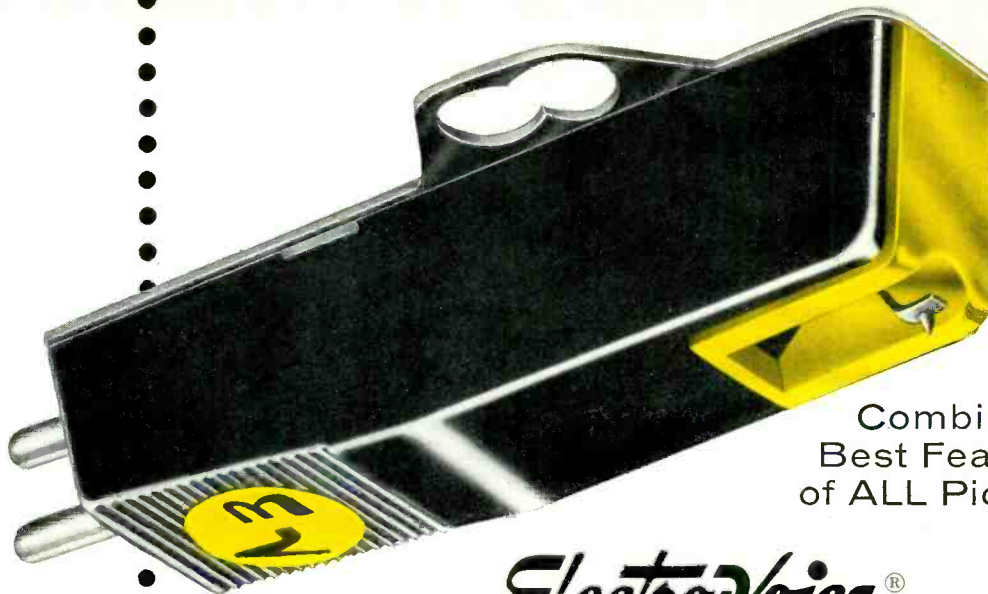

Combines
Best Features
of ALL Pickups!

Electro-Voice®

**NEW IMPROVED 80 SERIES
ULTRA-LINEAR CERAMIC CARTRIDGE**

THIS *TRUE* HIGH-FIDELITY cartridge embodies the most advanced concept in pickups. Combines all the *benefits* of ceramic and magnetic cartridges (with none of the disadvantages) in one pickup that fits any arm or plug-in head! Enjoys absolute freedom from unwanted case resonance because of unique, die-cast housing. Not affected by moisture or humidity.

TWO BASIC SERIES. Standard Model 80 Series works into any amplifier having a ceramic input. Model 80M Series provides replacement for *all* magnetic pickups with no adjustments or circuit modifications required.

**Here's Why You Should Use This
Completely New Ceramic Cartridge**

SUPERLATIVE RESPONSE! 20 to 20,000 cps.

LOWEST INTERMODULATION DISTORTION! LESS than 3% at 18 cm/sec.

HIGH OUTPUT! 80 Series. 500 millivolts. 80M Series, 25 millivolts at 5.5 cm/sec.

NO HUM! Absolutely non-inductive. Not sensitive to motor and transformer fields.

HIGH COMPLIANCE! 3 x 10⁻⁶ cm/dyne—several times the average hi-fi pickup compliance.

NO PREAMP REQUIRED! Standard 80 Series works into any amplifier having a ceramic input. 80M Series works into any magnetic cartridge input.

NO MODIFICATION NEEDED.



E-V 80 Series Turnover Pickup Provides Extra Benefits. Two independent generating cartridges in one! Full power for stylus in use . . . no distortion or resonance from unused stylus.

TYPE	STAND- ARD E-V MODEL	MAG- NETIC REPLAC- EMENT	STYLUS	NET	RECORD SPEED
Single Play	82S	82SM	3M Sapphire	\$ 9.60	78 RPM
Single Play	82D	82DM	3M Diamond	23.10	78 RPM
Single Play	84S	84SM	1M Sapphire	9.60	*45,33,16 Talking Book
Single Play	84D	84DM	1M Diamond	23.10	*45,33,16 Talking Book
Turnover	86TD	86TDM	1M Diamond 3M Diamond	48.00	*45,33,16 Talking Book 78 RPM
Turnover	86T	86TM	1M Diamond 3M Sapphire	34.50	*45,33,16 Talking Book 78 RPM

NOTE: The numeral "4" appearing in the model number indicates microgroove stylus; the numeral "2" denotes 78 rpm tip. "D" denotes one or more diamond styli; "S" stands for sapphire stylus. *Also 78 rpm Microgroove.

LABORATORY PROOF OF EXCEPTIONAL PERFORMANCE

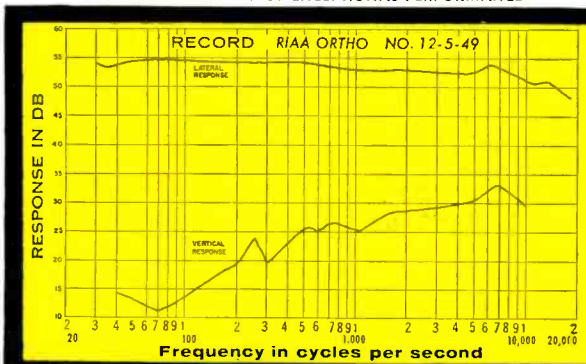

Get the facts! See your E-V distributor or send for illustrated data on E-V 80 Series Ceramic Cartridge.

Electro-Voice

ELECTRO-VOICE, INC. • BUCHANAN, MICHIGAN

CANADA: E-V of Canada Ltd., 1908 Avenue Road, Toronto, Ontario
EXPORT: 13 East 40th Street, New York 16, U.S.A.
Cables: ARLAB

Advanced
 engineering
 and precision-
 manufacture
 build

LONG LIFE

into RCA

RECEIVING TUBES

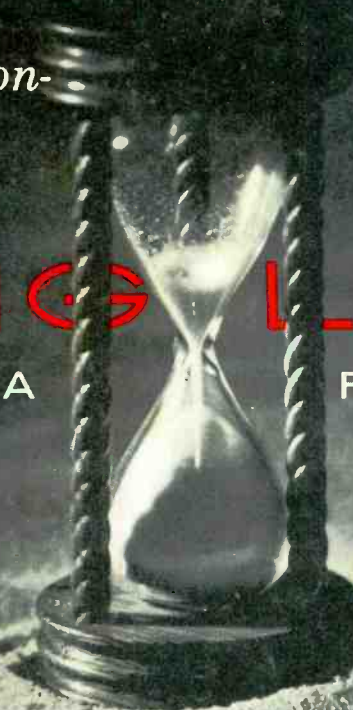

A receiving tube that delivers, and keeps on delivering at maximum performance levels doesn't just happen—it *has to be made to happen!*

Stringent quality control checks govern each part and each process in the manufacture of all RCA Receiving Tubes. Take the RCA-6AU6, for instance: The control grid is silver-plated to minimize grid emission and to give low contact potential; carefully processed cathode materials minimize leakage and mica support is specially treated to insure low inter-electrode leakage; result—Long Life! To insure noise-free performance—each tube is “receiver-tested.” Avoid costly callbacks—standardize on RCA. Tell your distributor to fill your tube order with RCA Tubes only.



RECEIVING TUBES
 RADIO CORPORATION OF AMERICA